True Zero Speed, High Accuracy, Gear Tooth Sensor IC

Last Time Buy

These parts are in production but have been determined to be LAST TIME BUY. This classification indicates that the product is obsolete and notice has been given. Sale of this device is currently restricted to existing customer applications. The device should not be purchased for new design applications because of obsolescence in the near future. Samples are no longer available.

Date of status change: August 16, 2010

Deadline for receipt of LAST TIME BUY orders: October 29, 2010.

Recommended Substitutions:

For existing customer transition, and for new customers or new applications, refer to the [ATS667](#).

NOTE: For detailed information on purchasing options, contact your local Allegro field applications engineer or sales representative.

Allegro MicroSystems, Inc. reserves the right to make, from time to time, revisions to the anticipated product life cycle plan for a product to accommodate changes in production capabilities, alternative product availabilities, or market demand. The information included herein is believed to be accurate and reliable. However, Allegro MicroSystems, Inc. assumes no responsibility for its use; nor for any infringements of patents or other rights of third parties which may result from its use.

True Zero Speed, High Accuracy, Gear Tooth Sensor IC

Features and Benefits

- True zero-speed operation
- Switchpoints independent of air gap
- High vibration immunity
- Precise duty cycle signal over operating temperature range
- Large operating air gaps
- Defined power-on state
- Wide operating voltage range
- Digital output representing target profile
- Single-chip sensing IC for high reliability
- Small mechanical size
- Optimized Hall IC magnetic system
- 200 μ s power-on time at gear speed < 100 rpm
- AGC and reference adjust circuit
- Undervoltage lockout

Package: 4-pin SIP (suffix SG)

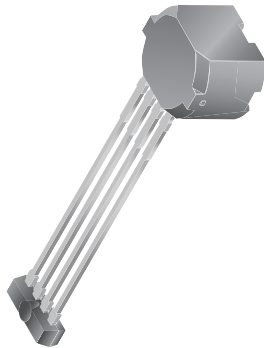

Not to scale

Description

The ATS665 true zero-speed gear tooth sensor IC is an optimized Hall IC/rare earth pellet configuration designed to provide a user-friendly solution for digital gear tooth sensing applications. The over-molded package, holds together a samarium cobalt pellet, a pole piece and a true zero-speed Hall IC that has been optimized to the magnetic circuit. This small package can be easily assembled and used in conjunction with gears of various shapes and sizes.

The device incorporates a dual element Hall IC that switches in response to differential magnetic signals created by a ferromagnetic target. The IC contains a sophisticated compensating circuit designed to reduce the detrimental effects of magnet and system offsets. Digital processing of the analog signal provides zero speed performance independent of air gap and also dynamic adaptation of device performance to the typical operating conditions found in automotive applications (reduced vibration sensitivity). High-resolution peak detecting DACs are used to set the adaptive switching thresholds of the device. Hysteresis in the thresholds reduces the negative effects of any anomalies in the magnetic signal associated with the targets used in many automotive applications.

Continued on the next page...

Functional Block Diagram

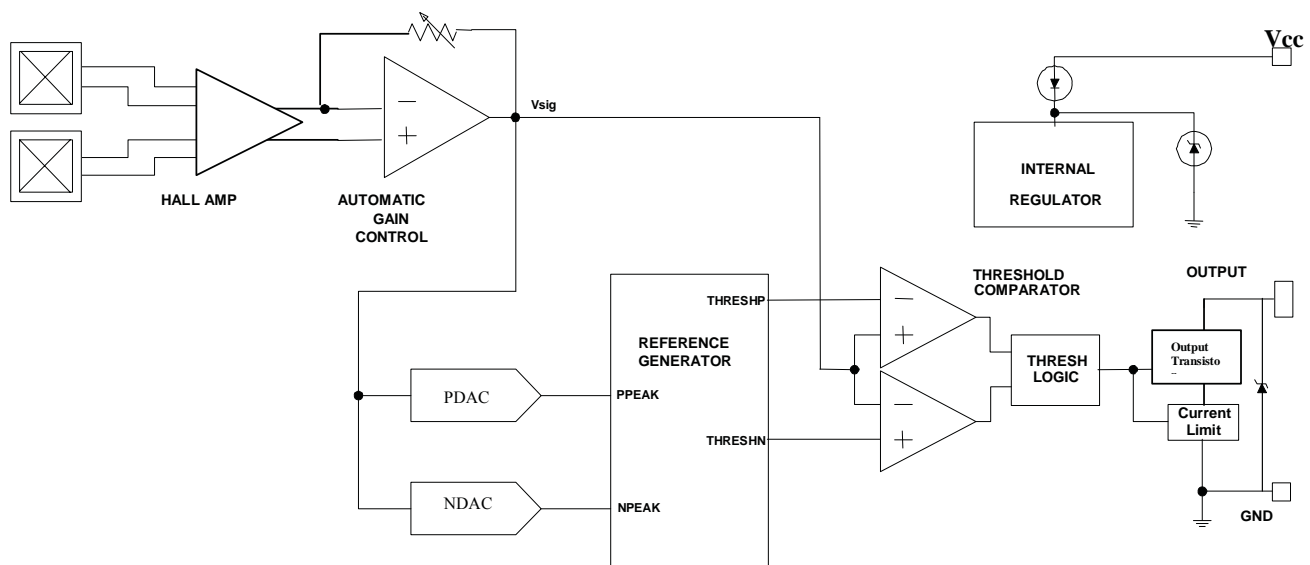

ATS665LSG

True Zero Speed, High Accuracy, Gear Tooth Sensor IC

Description (continued)

This ATS665's ability to provide tight duty cycle at high speeds and over a wide temperature range makes it ideal for transmission and industrial speed applications. The ATS665 is available in the SG package in the automotive temperature range, -40° to 150° (L). It is lead (Pb) free with 100% matte tin leadframe plating



Selection Guide

Part Number	Packing*
ATS665LSGTM-T	800 pieces per reel

*Contact Allegro® for additional packing options

Absolute Maximum Ratings

Characteristic	Symbol	Notes	Rating	Unit
Supply Voltage	V _{CC}	See Power Derating section	26.5	V
Reverse Supply Voltage	V _{RCC}		-18	V
Reverse Output Current	I _{RCC}	V _{OUT} ≥ -0.5 V	50	mA
Continuous Output Current	I _{OUT}		20	mA
Operating Ambient Temperature	T _A	Range L	-40 to 150	°C
Maximum Junction Temperature	T _{J(max)}		165	°C
Storage Temperature	T _{stg}		-65 to 170	°C

Pin-out Diagram

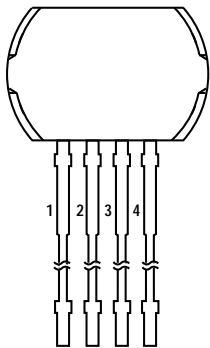

Terminal List

Number	Name	Function
1	VCC	Device supply
2	VOUT	Device output
3	-	Tie to GND or float
4	GND	Ground

OPERATING CHARACTERISTICS Valid at $T_A = -40^\circ\text{C}$ to 150°C over air gap, typical operating parameters $V_{CC} = 12\text{ V}$ and $T_A = 25^\circ\text{C}$; unless otherwise noted

Characteristics	Symbol	Test Conditions	Min.	Typ.	Max.	Unit
Electrical Characteristics						
Supply Voltage	V_{CC}	Operating; $T_J < T_J(\text{max})$	3.3	–	24	V
Undervoltage Lockout	$V_{CC(\text{UV})}$		–	–	$<V_{CC(\text{min})}$	V
Reverse Supply Current	I_{RCC}	$V_{CC} = -18\text{ V}$	–	–	-10	mA
Supply Zener Clamp Voltage	V_Z	$I_{CC} = I_{\text{con}}(\text{max}) + 3\text{ mA}$, $T_A = 25^\circ\text{C}$	26.5	–	–	V
Supply Zener Current	I_Z	Test only; $V_{CC} = 28\text{ V}$, $T_J < T_J(\text{max})$	–	–	$I_{\text{con}}(\text{max}) + 3$	mA
Supply Current	I_{CC}	Output off	–	8	14	mA
		Output on	–	8	14	mA
Power-On State Characteristics						
Power-On State	S_{PO}		–	High	–	–
Power-On Time	t_{PO}	Gear speed $< 100\text{ rpm}$; $V_{CC} > V_{CC(\text{min})}$	–	–	200	μs
Output Stage						
Low Output Voltage	V_{sat}	Output = on, $I_{\text{SINK}} = 20\text{ mA}$	–	225	400	mV
Output Current Limit	I_{lim}	$V_{\text{OUT}} = 12\text{ V}$, $T_J < T_J(\text{max})$	25	45	70	mA
Output Leakage Current	I_{OFF}	Output = off, $V_{\text{OUT}} = 24\text{ V}$	–	–	10	μA
Output Rise Time	t_r	$R_{\text{LOAD}} = 500\ \Omega$, $C_{\text{LOAD}} = 10\text{ pF}$	–	1.0	2	μs
Output Fall Time	t_f	$R_{\text{LOAD}} = 500\ \Omega$, $C_{\text{LOAD}} = 10\text{ pF}$	–	0.6	2	μs
Switchpoint Characteristics						
Target Speed	S	Reference target	0	–	12000	rpm
Bandwidth	$f_{-3\text{dB}}$		–	20	–	kHz
Operate Point	B_{OP}	% of peak-to-peak signal, $AG < AG(\text{max})$	–	70	–	%
Release Point	B_{RP}	% of peak-to-peak signal, $AG < AG(\text{max})$	–	30	–	%
Calibration						
Initial Calibration		Start-up, power-on speed $\leq 200\text{ rpm}$	–	2	6	Edges
Calibration Update		Running mode operation	Continuous			
Operating Characteristics (with 60-0 reference target)						
Operational Air Gap	AG	Measured from package face to top of target tooth	0.5	–	2.5	mm
Duty Cycle		$AG < AG(\text{max})$, reference target	42	47	52	%
Operating Signal		Duty cycle spec compliance	60	–	–	G

Characteristic Performance

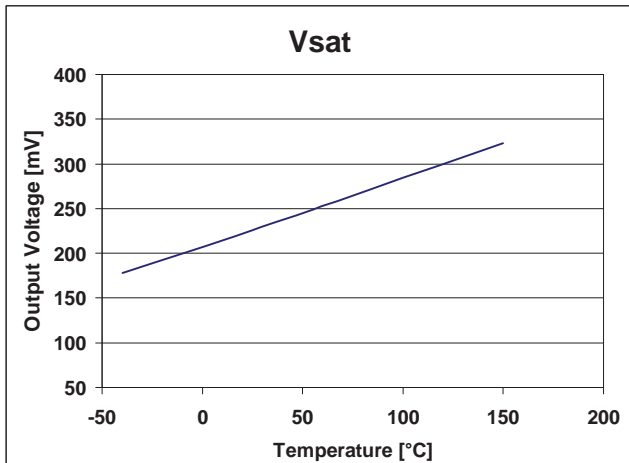
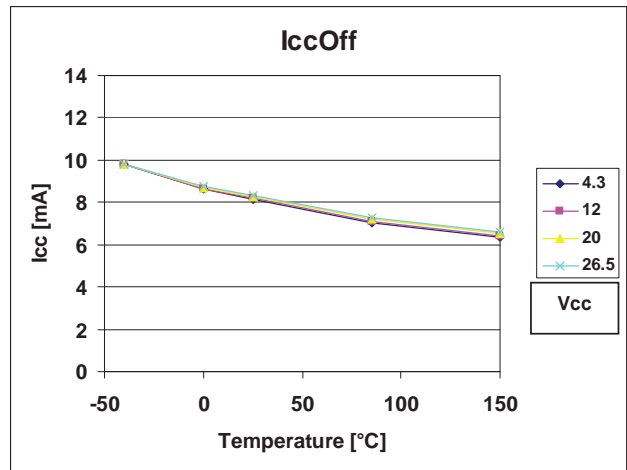
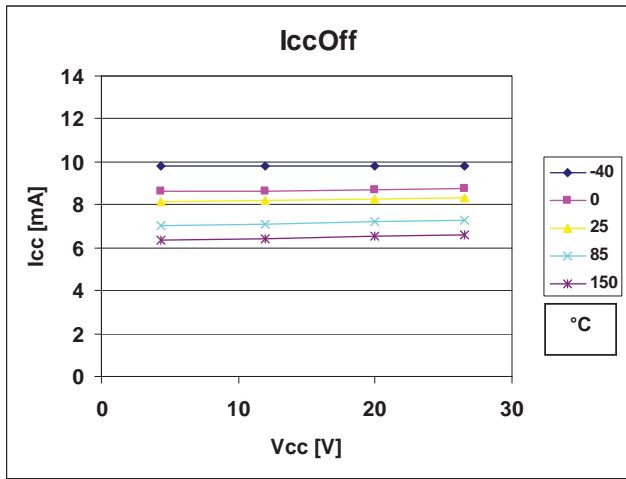
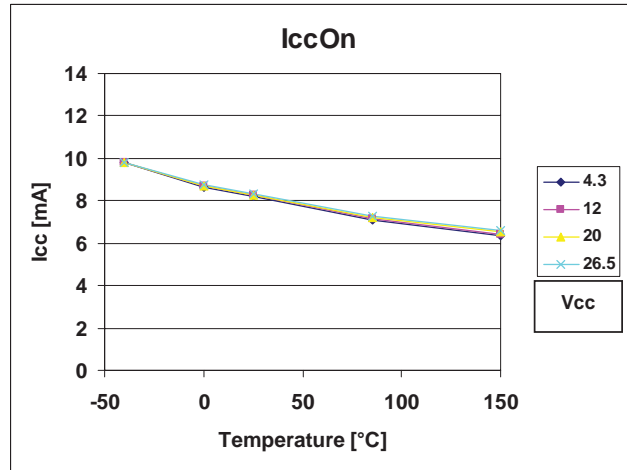
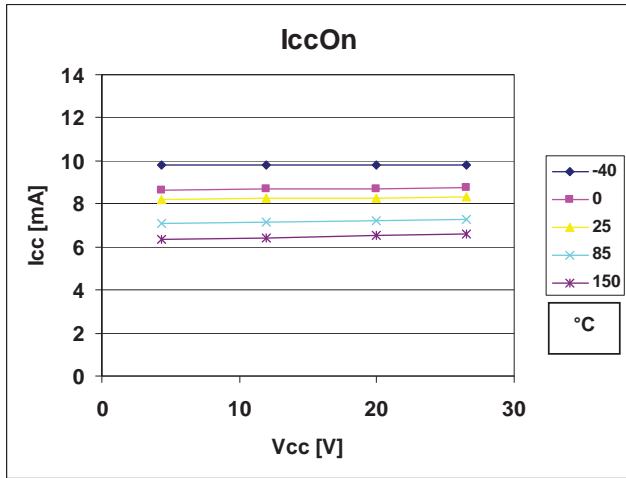

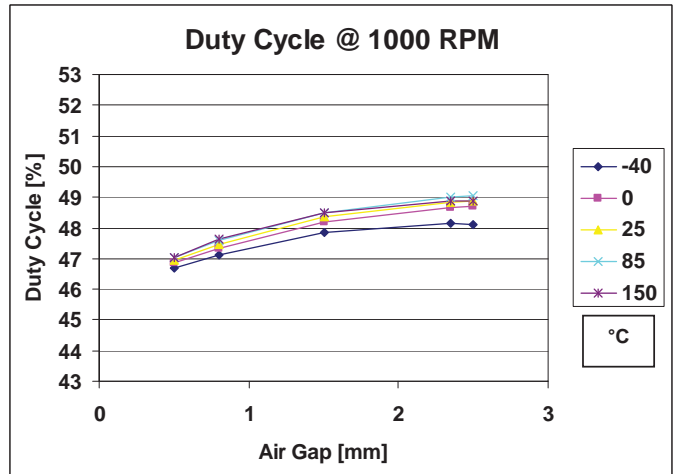
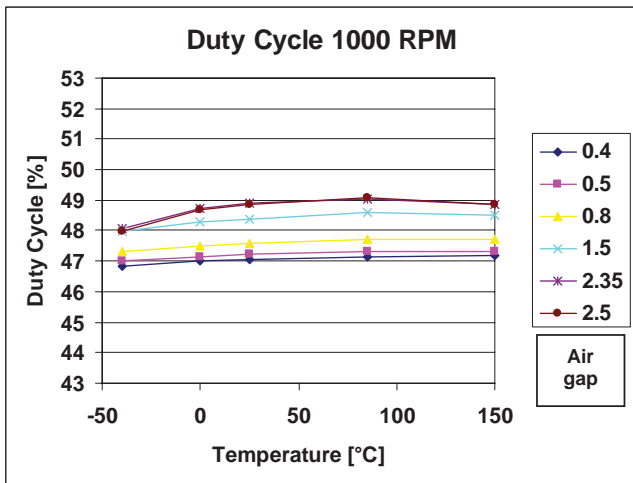
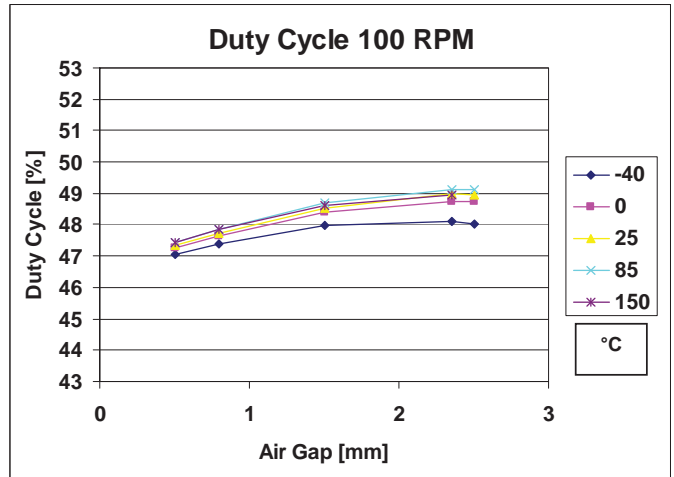
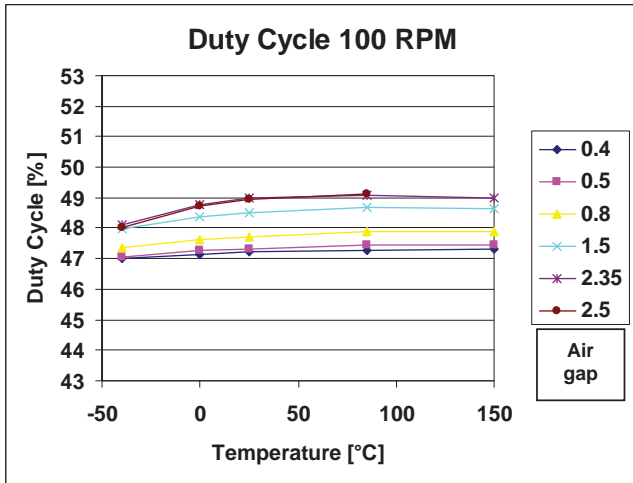

Reference Target / Gear Information

Diameter	120	mm
Thickness	6	mm
Tooth Width	3	mm
Valley Width	3	mm
Valley Depth	3	mm
Material	Low carbon steel	

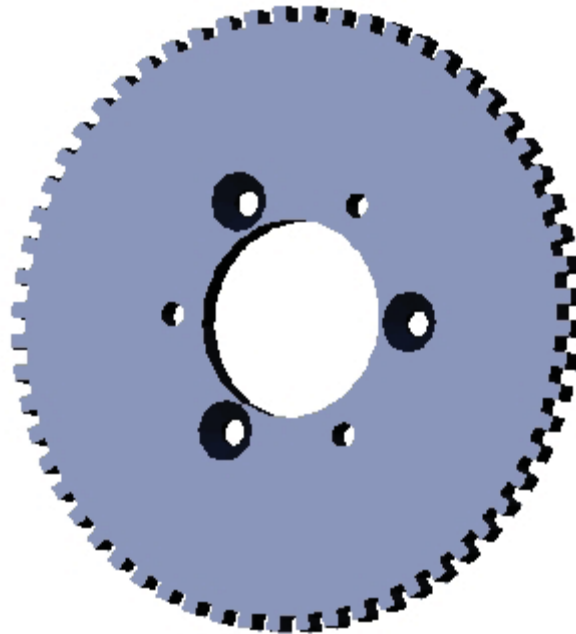

Functional Description

Device Description

The ATS665 true zero speed gear tooth sensor IC is a Hall IC/ rare earth pellet configuration that is fully optimized to provide digital detection of gear tooth edges. This device is integrally molded into a plastic body that has been optimized for size, ease of assembly, and manufacturability. High operating temperature materials are used in all aspects of construction.

Hall Technology

The device contains a single-chip differential Hall effect sensor IC, a samarium cobalt pellet, and a flat ferrous pole piece. The Hall IC consists of two Hall elements spaced 2.2 mm apart which measure the magnetic gradient created by the passing of a ferrous object. The gradient is converted to an analog voltage that is then processed to provide a digital output signal.

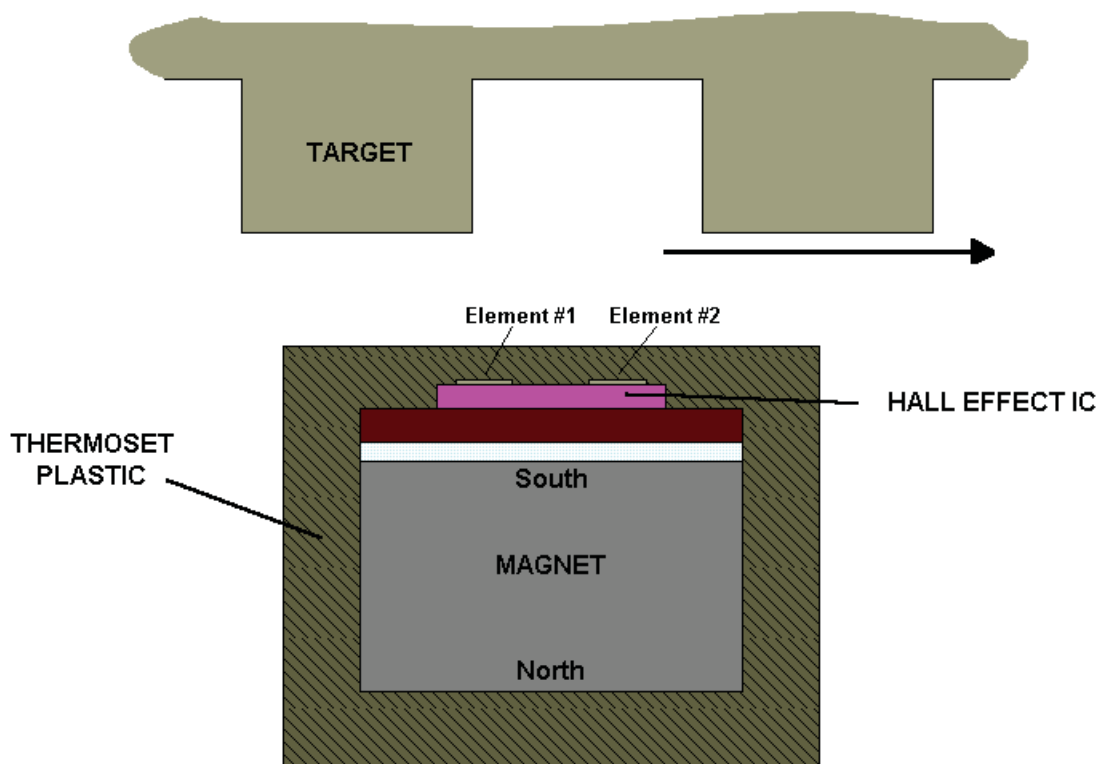

Operation

After proper power is applied to the component the IC is then capable of providing digital information that is representative of the profile of a rotating gear. No additional optimization is needed and minimal processing circuitry is required. This ease of use should reduce design time and incremental assembly costs for most applications. The following output diagram is indicative of the IC's performance for the polarity indicated in the figure at the bottom of the page.

Output Polarity

The output of the IC will switch from low to high as the leading edge of the tooth passes the package face in the direction indicated in the figure below. In this system configuration, the output voltage will be high when the package is facing a tooth. If rotation occurs in the opposite direction, the output polarity will invert.

Power-On State Operation:

The device is guaranteed to power up in the off state (logic high output).

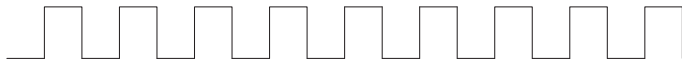

MECHANICAL PROFILE



MAGNETIC PROFILE



IC ELECTRICAL OUTPUT PROFILE

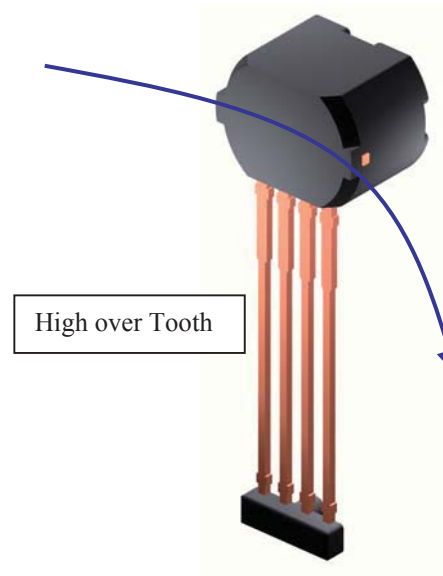

Start-up Detection

Since the IC powers-up in the off state (logic high output), the first edge seen by the IC can be missed if the switching induced by that edge reinforces the off state. Therefore, the first edge that can be

guaranteed to induce an output transition is the second detected edge. This device has accurate first electrical falling edge detection. The tables below show various start-up schemes.

High over Tooth →

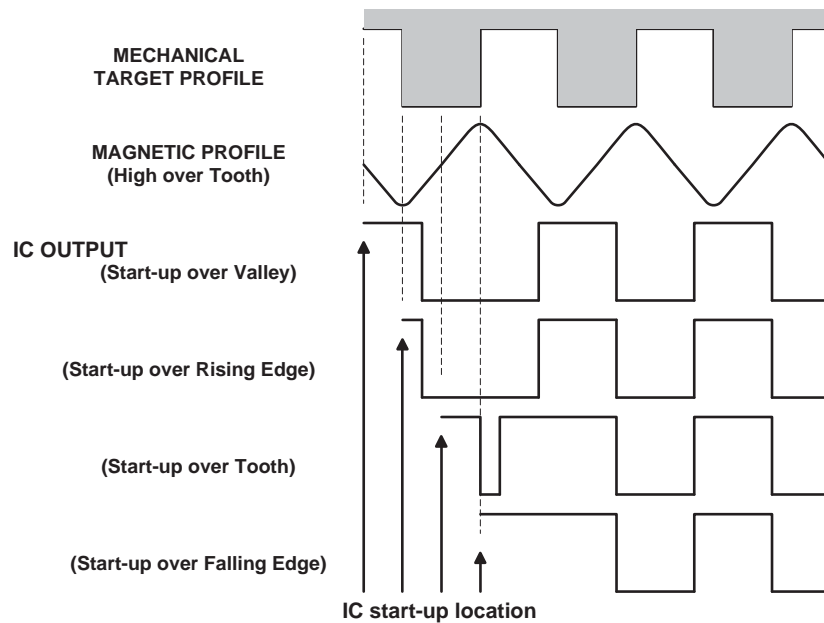

Low over Tooth →

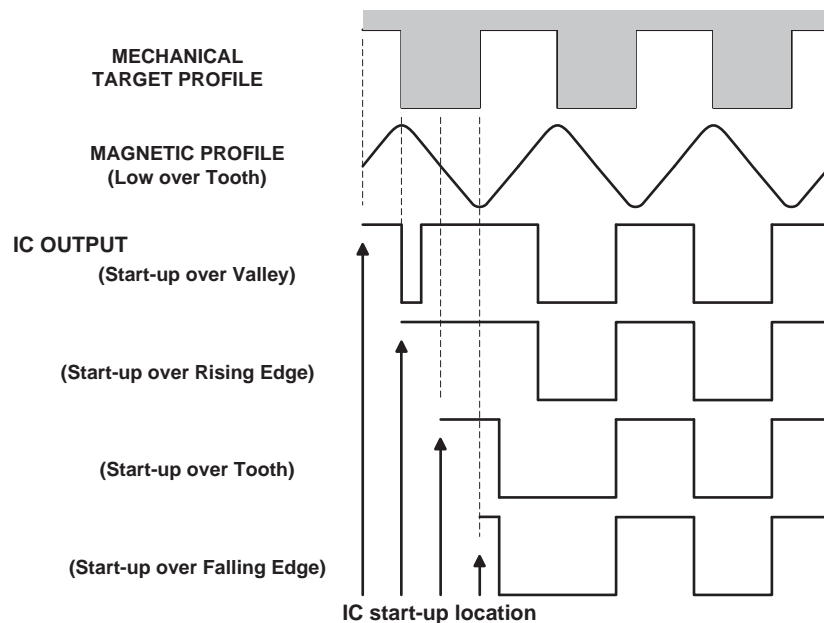

Undervoltage Lockout

When the supply voltage falls below the minimum operating voltage, V_{CCUV} , the device turns off and stays off irrespective of the state of the magnetic field. This prevents false signals caused by undervoltage conditions from propagating to the output of the IC.

Power Supply Protection

The device contains an on-chip regulator and can operate over a wide supply voltage range. For devices that need to operate from an unregulated power supply, transient protection must be added externally. For applications using a regulated line, EMI/RFI protection may still be required. The following circuit is the most basic configuration required for proper device operation. For

EMC information, contact your Allegro representative.

Internal Electronics

The ATS665 contains a self-calibrating Hall effect IC that possesses two Hall elements, a temperature compensated amplifier and offset cancellation circuitry. The IC also contains a voltage regulator that provides supply noise rejection over the operating voltage range. The Hall transducers and the electronics are integrated on the same silicon substrate using a proprietary BiCMOS process. Changes in temperature do not greatly affect this device due to the stable amplifier design and the offset rejection circuitry.

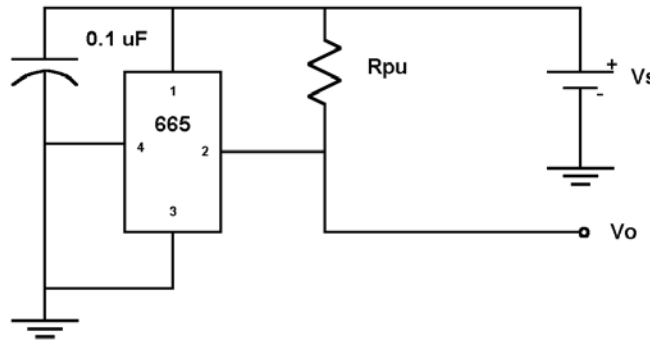

Automatic Gain Control (AGC)

The patented self-calibrating circuitry is unique. After each power up, the device measures the peak-to-peak magnetic signal. The gain of the IC is then adjusted which keeps the internal signal amplitude constant over the air gap range of the device. This feature provides operational characteristics independent of air gap.

Offset Adjust

In addition to normalizing performance over air gap, the gain control circuitry also reduces the effect of chip, magnet, and installation offsets. This is accomplished using two D/A converters that capture the peak and valley of the signal and use it as a reference for the switching comparator. If induced offsets bias the absolute signal up or down, AGC and the dynamic DAC behavior work to normalize and reduce the impact of the offset on IC performance.

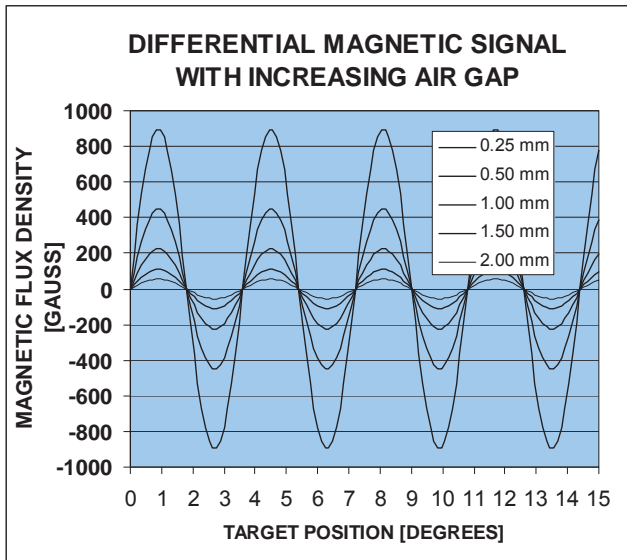

Magnetic Signal with no Amplification

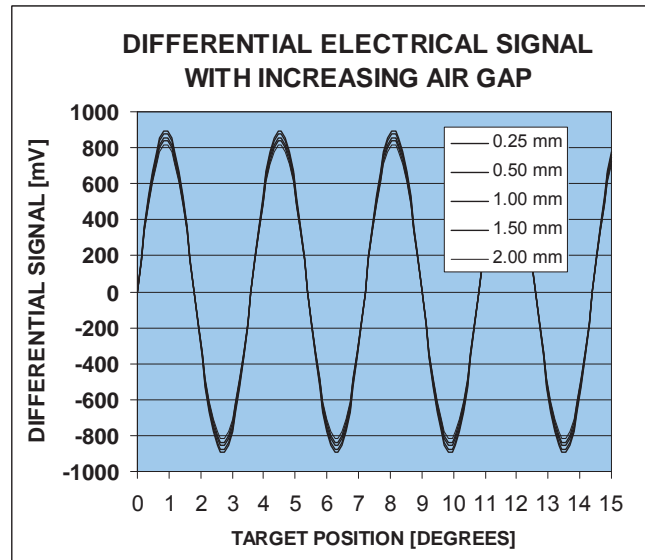

Electrical Signal after AGC

Switchpoints

Switchpoints in the ATS665 are established dynamically as a percentage of the amplitude of the normalized magnetic signal. Two DACs track the peaks of the normalized magnetic signal (see the section on Update); the switching thresholds are established at 30% and 70% of the two DAC's values. The proximity of the thresholds near 50% ensures the most accurate and consistent switching where the signal is steepest and least affected by air gap variation.

The hysteresis of 40% provides high air gap performance and

immunity to false switching on noise, vibration, backlash and other transient events. Since the hysteresis value is independent of air gap, it provides protection against false switching in the presence of overshoot that can be induced on the edges of large teeth.

The figure below graphically demonstrates the establishment of the switching threshold levels. Because the threshold are established dynamically as a percentage of the peak-peak signal, the effect of a baseline shift is minimized. As a result, the effects of offsets induced by tilted or off-center installation are minimized.

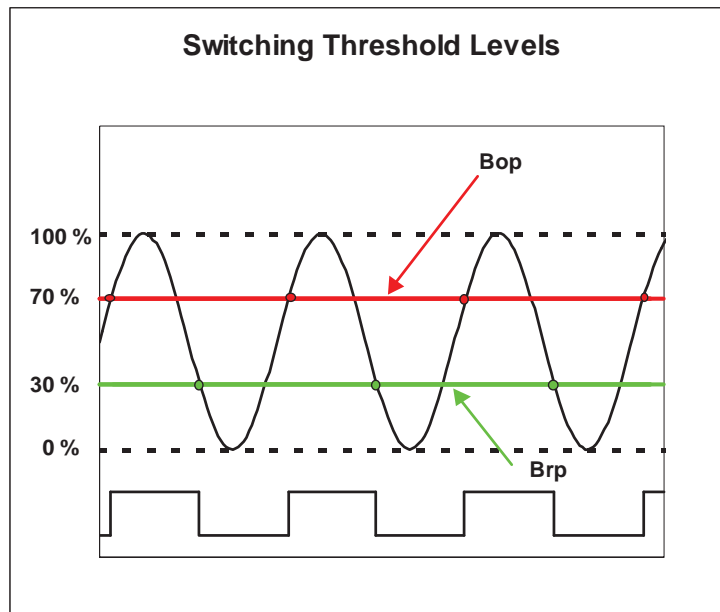

Update

The ATS665 incorporates an algorithm that continuously monitors the system and updates the switching thresholds accordingly. The switchpoint for each edge is determined by the previous two edges. Since variations are tracked in real time, the IC has

high immunity to target run-out and retains excellent accuracy and functionality in the presence of both run-out and transient mechanical events. The figures below show how the IC uses historical data to provide the switching threshold for a given edge.

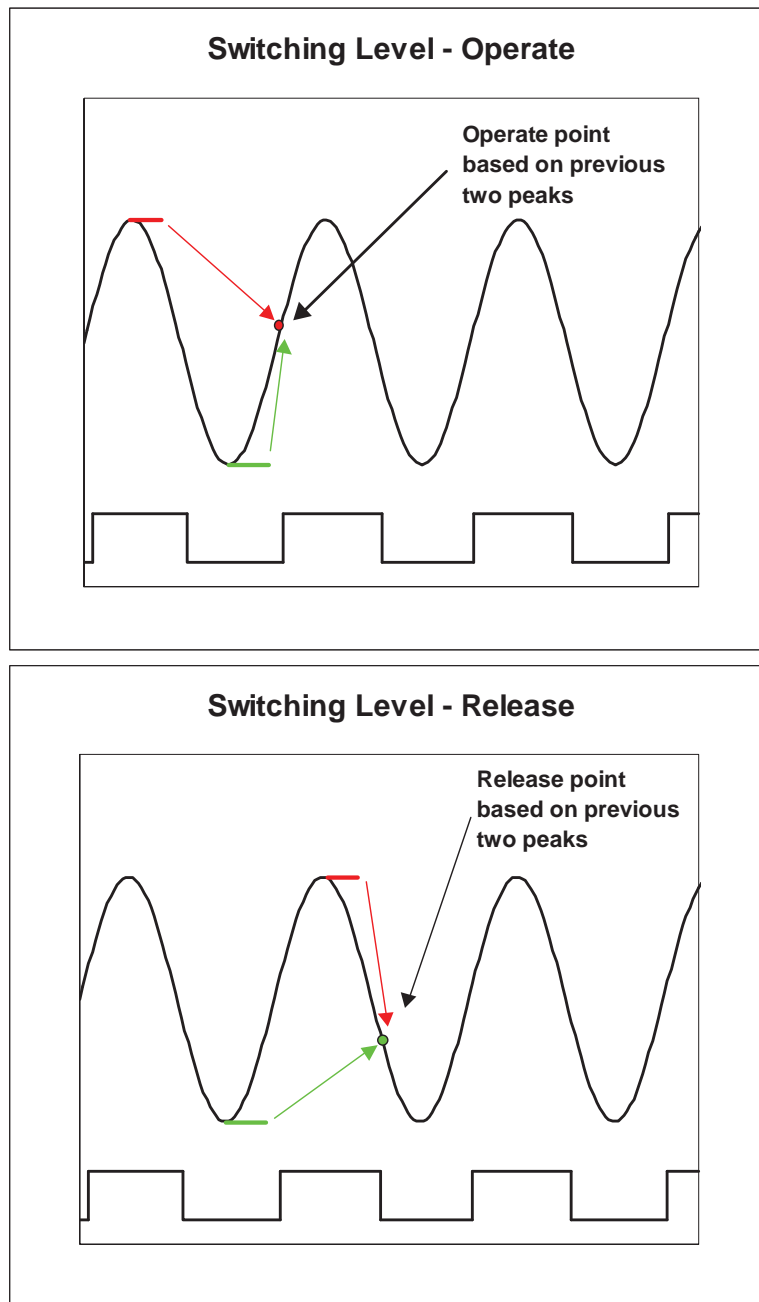

IC/Target Evaluation

In order to establish the proper operating specification for a particular IC/target system, a systematic evaluation of the magnetic circuit should be performed. The first step is the generation of a magnetic map of the target. By using a calibrated device, a magnetic signature of the system is made. At right is a map of the 60-0 reference target. Flux density shown is the differential of the magnetic fields sensed at the two Hall elements.

A single curve is distilled from this map data that describes the peak-peak magnetic field versus air gap. Knowing the minimum amount of magnetic flux density that guarantees operation of the IC, one can determine the maximum operational air gap of the IC/target system. Referring to the chart below right, a minimum required peak-peak signal of 60 G corresponds to a maximum air gap of approximately 2.5 mm.

Target Design

For the generation of adequate magnetic field levels to maximize air gap performance, the following recommendations should be followed in the design and specification of targets.

- Tooth width > 2 mm
- Valley width > 2 mm
- Valley depth > 2 mm
- Gear thickness > 3 mm
- Target material must be low carbon steel

Though these parameters apply to targets of traditional geometry (radially oriented teeth with radial sensing), they can be applied to stamped targets as well. For stamped geometries with axial sensing, the valley depth is intrinsically infinite so the criteria for tooth width, valley width, material thickness (can be < 3 mm) and material specification need only be considered.

Accuracy

While the update algorithm will allow the IC to adapt to system changes (i.e. air gap increase), major changes in air gap can adversely affect switching performance. When characterizing IC performance over a significant air gap range, be sure to re-power the device at each air gap. This ensures that self-calibration occurs for each installation condition. See the section entitled Characteristic Data for typical duty cycle performance.

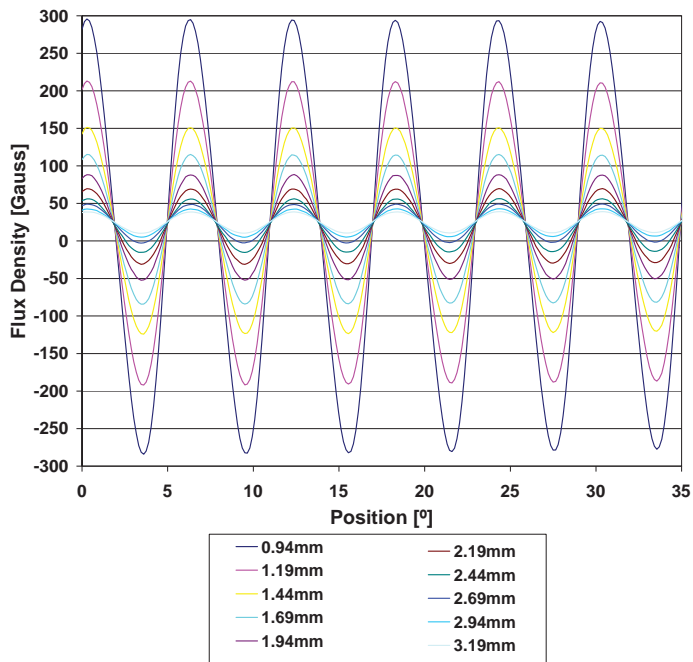

ATS665LSG 60-0 TARGET MAP

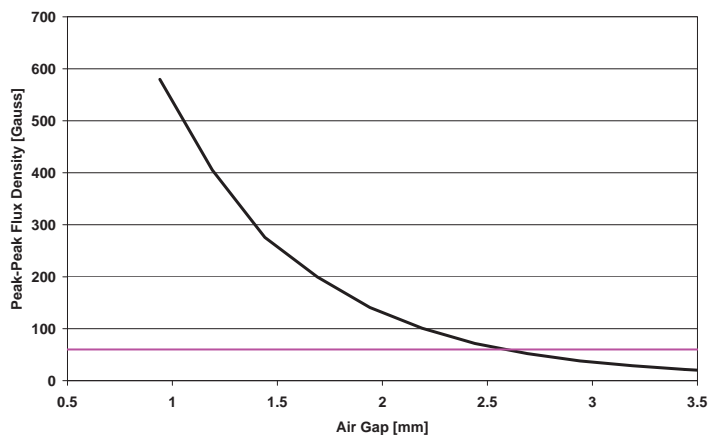

Power Derating

Due to internal power consumption, the junction temperature of the IC, T_J , is higher than the ambient environment temperature, T_A . To ensure that the device does not operate above the maximum rated junction temperature use the following calculations:

$$\Delta T = P_D \times R_{\theta JA}$$

Where:

$$P_D = V_{CC} \times I_{CC}$$

$$\therefore \Delta T = V_{CC} \times I_{CC} \times R_{\theta JA}$$

Where ΔT denotes the temperature rise resulting from the IC's power dissipation.

$$T_J = T_A + \Delta T$$

For the IC:

$$T_J(\text{max}) = 165^\circ\text{C}$$

$$R_{\theta JA} = 126^\circ\text{C/W}$$

Typical T_J calculation:

$$T_A = 25^\circ\text{C}$$

$$V_{CC} = 5\text{ V}$$

$$I_{CC} = 7.0\text{ mA}$$

$$P_D = V_{CC} \times I_{CC} = 5\text{ V} \times 8.0\text{ mA} = 40.0\text{ mW}$$

$$\Delta T = P_D \times R_{\theta JA} = 40.0\text{ mW} \times 126^\circ\text{C/W} = 5.0^\circ\text{C}$$

$$T_J = T_A + \Delta T = 25^\circ\text{C} + 5.0^\circ\text{C} = 30.0^\circ\text{C}$$

Maximum Allowable Power Dissipation Calculation for ATS665:

Assume:

$$T_A = T_A(\text{max}) = 165^\circ\text{C}$$

$$T_J(\text{max}) = 165^\circ\text{C}$$

$$I_{CC} = 12.0\text{ mA}$$

If:

$$T_J = T_A + \Delta T$$

Then, at $T_A = 150^\circ\text{C}$:

$$\Delta T(\text{max}) = T_J(\text{max}) - T_A(\text{max}) = 165^\circ\text{C} - 150^\circ\text{C} = 15^\circ\text{C}$$

If:

$$\Delta T = P_D \times R_{\theta JA}$$

Then, at $T_A = 150^\circ\text{C}$:

$$P_D(\text{max}) = \Delta T(\text{max}) / R_{\theta JA} = 15^\circ\text{C} / 126^\circ\text{C/W} = 119\text{ mW}$$

If:

$$P_D = V_{CC} \times I_{CC}$$

Then the maximum V_{CC} at 150°C is therefore:

$$V_{CC}(\text{max}) = P_D(\text{max}) / I_{CC} = 119\text{ mW} / 12.0\text{ mA} = 9.9\text{ V}$$

This value applies only to the voltage drop across the 665 chip. If a protective series diode or resistor is used, the effective maximum supply voltage is increased.

For example, when a standard diode with a 0.7 V drop is used:

$$V_S(\text{max}) = 9.9\text{ V} + 0.7\text{ V} = 10.6\text{ V}$$

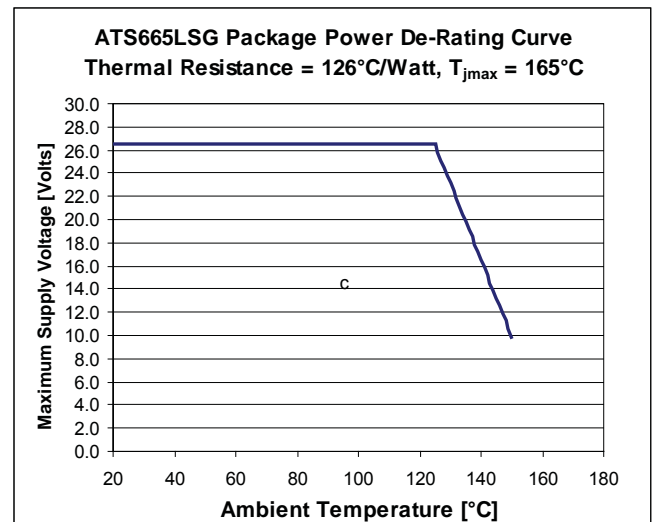

Copyright ©1993-2009, Allegro MicroSystems, Inc.

The products described herein are manufactured under one or more of the following U.S. patents: 5,264,783; 5,389,889; 5,442,283; 5,517,112; 5,581,179; 5,619,137; 5,621,319; 5,650,719; 5,686,894; 5,694,038; 5,729,130; 5,917,320; 6,091,239; 6,100,680; 6,232,768; 6,242,908; 6,265,865; 6,297,627; 6,525,531; 6,690,155; 6,693,419; 6,919,720; 7,046,000; 7,053,674; 7,138,793; 7,199,579; 7,253,614; 7,365,530; 7,368,904; or other patents pending.

Allegro MicroSystems, Inc. reserves the right to make, from time to time, such departures from the detail specifications as may be required to permit improvements in the performance, reliability, or manufacturability of its products. Before placing an order, the user is cautioned to verify that the information being relied upon is current.

Allegro's products are not to be used in life support devices or systems, if a failure of an Allegro product can reasonably be expected to cause the failure of that life support device or system, or to affect the safety or effectiveness of that device or system.

The information included herein is believed to be accurate and reliable. However, Allegro MicroSystems, Inc. assumes no responsibility for its use; nor for any infringement of patents or other rights of third parties which may result from its use.

For the latest version of this document, visit our website:

www.allegromicro.com

