

HC4

High Power Resonant Capacitors



FEATURES

High AC Voltage - High current

APPLICATIONS

Induction Heating - Tank Circuits

KVAR	350	400	
MAXIMUM CORE TEMPERATURE	+85°C		
SURFACE TEMPERATURE	+45°C (Above 45°C the KVAR rating must be de-rated by 2.25%/°C)		
CONSTRUCTION	Self-healing		
SELF INDUCTANCE	<5 nH		
DIELECTRIC	Polypropylene		

Standard part listing

Capacitance (µF)	VAC	IC PART number	Maximum RMS current (A)	MAX power kvar	Frequency range (kHz)	ESR (mΩ) 100kHz, +25°C	Dimensions (mm)			Terminal Style
							B	H	L	
0.15	1000	154HC4102K2UM8	450	400	425-538	2.0	30.2	55	73	2UM8
0.20	1000	204HC4102K2UM8	450	400	319-404	1.8	30.2	55	73	2UM8
0.25	1000	254HC4102K2UM8	450	400	256-323	1.5	30.2	55	73	2UM8
0.30	1000	304HC4102K2UM8	600	400	213-478	1.2	30.2	55	73	2UM8
0.33	1000	334HC4102K2EM8	600	400	194-433	1.0	30.2	66	56	2EM8
0.50	700	504HC4700K2UM8	600	400	259-285	1.0	30.2	55	73	2UM8
0.66	700	664HC4700K2UM8	600	400	197-220	0.8	30.2	55	73	2UM8
0.66	1000	664HC4102K2EM8	600	400	95-216	0.8	30.2	66	56	2EM8
1.00	700	105HC4700K2UM8	750	400	129-223	0.6	30.2	55	73	2UM8
1.20	900	125HC4900K2EM8	850	400	58-215	0.3	30.2	66	56	2EM8
1.30	500	135HC4500K2UM8	750	350	170-196	0.5	30.2	55	73	2UM8
1.32	900	135HC4900K2EM8	850	400	58-215	0.3	30.2	66	56	2EM8
1.50	500	155HC4500K2UM8	800	350	148-170	0.4	30.2	55	73	2UM8
2.00	500	205HC4500K2UM8	800	350	110-145	0.2	30.2	55	73	2UM8
2.60	700	265HC4700K2EM8	950	400	51-138	0.2	30.2	66	56	2EM8
5.00	500	505HC4500K2EM8	1000	400	50-80	0.1	30.2	66	56	2EM8



Your Global Source for World-Class Capacitors

© 2013 Illinois Capacitor, Inc.

North America
Tel: 847.675.1760
sales@illcap.com

Asia
Tel: 852.2793 0931
sales@illcap.com.hk

HC4

High Power Resonant Capacitors



LEAD STYLE: 2EM8

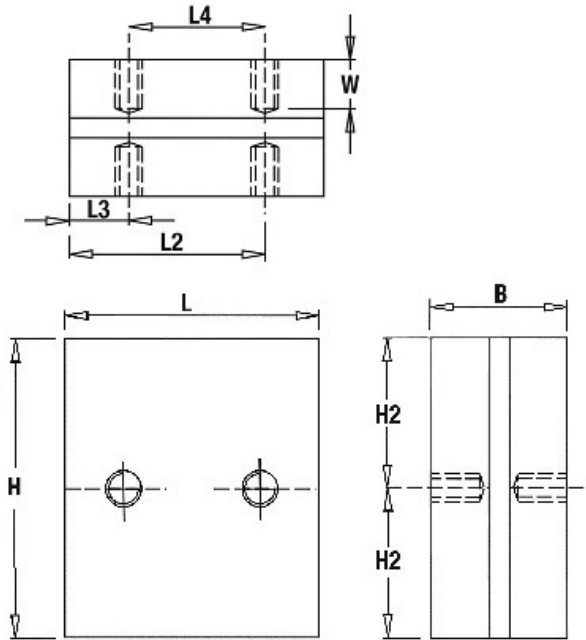

L	H	B	H2	L2	L3	L4	W
56±0.5	66±0.5	30.2±0.1	33	43	13	30	9
Mounting Holes: M8x1.25 tap fitted with SS helicoil							
Tightening torque: 15Nm MAX							

LEAD STYLE: 2UM8

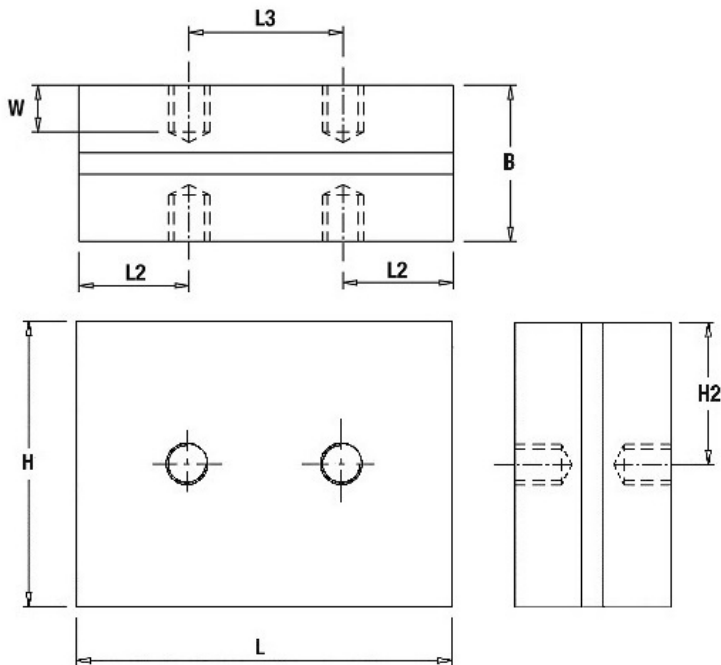

L	H	B	W	L2	L3	H2
73±1	55±1	30.2±0.1	9	21.5	30	27.5
Mounting holes: M8 full thread with SS helicoil						
Tightening torque: 15Nm MAX						



Your Global Source for World-Class Capacitors

© 2013 Illinois Capacitor, Inc.

North America
Tel: 847.675.1760
sales@illcap.com

Asia
Tel: 852.2793 0931
sales@illcap.com.hk

HC4

High Power Resonant Capacitors



Capacitance (μF)	VAC	IC PART number	Maximum RMS current (A)	MAX power kvar	Frequency range (kHz)	ESR (mΩ) 100kHz, +25°C	Dimensions (mm)			Terminal Style
							B	H	T	
0.33	1000	334HC4102K4TM6	600	400	194-433	1.0	30.2	60	60	4TM6
0.66	1000	664HC4102K4TM6	600	400	95-216	0.8	30.2	60	60	4TM6
1.2	900	125HC4900K4TM6	850	400	58-215	0.3	30.2	60	60	4TM6
1.32	900	135HC4900K4TM6	850	400	58-215	0.3	30.2	60	60	4TM6
2.6	700	265HC4700K4TM6	950	400	51-138	0.2	30.2	60	60	4TM6
5	500	505HC4500K4TM6	1000	400	50-80	0.1	30.2	60	60	4TM6

LEAD STYLE: 4TM6

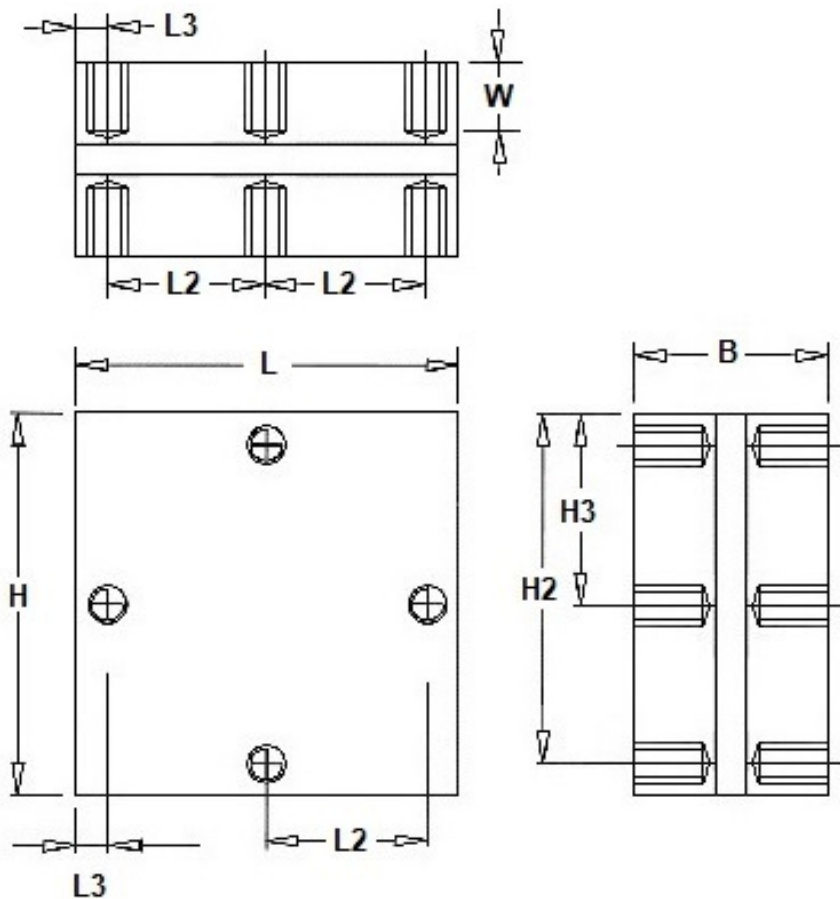

L	H	B	H2	H3	L2	L3	W
60 _{+0.5}	60 _{+0.5}	30.2 _{+0.1}	55	30	25	5	10 _{+0.5}
Mounting Holes: M6x1 tap fitted with SS helicoil							
Tightening torque: 15Nm MAX							



Your Global Source for World-Class Capacitors

© 2013 Illinois Capacitor, Inc.

North America
Tel: 847.675.1760
sales@illcap.com

Asia
Tel: 852.2793 0931
sales@illcap.com.hk

HC4

High Power Resonant Capacitors



Frequency Derating

— Voltage — Current — Power

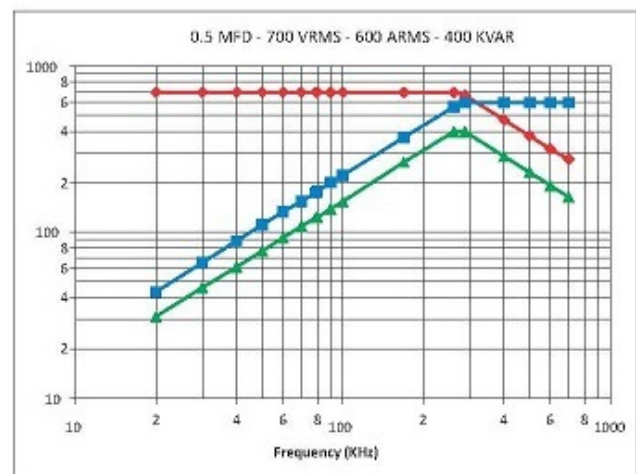
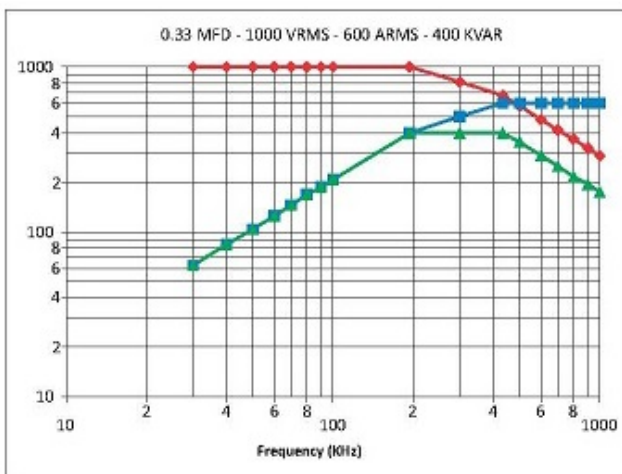
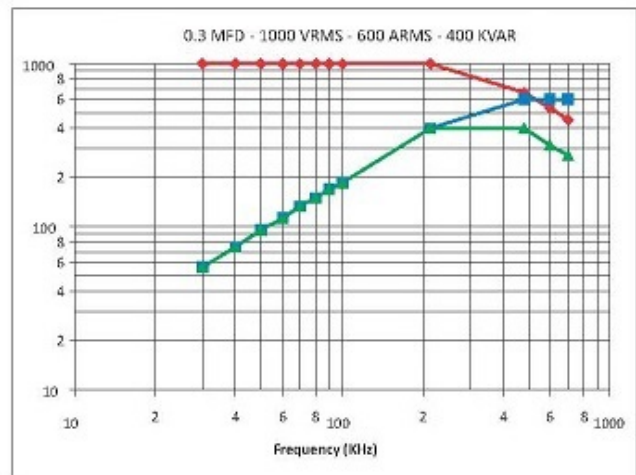
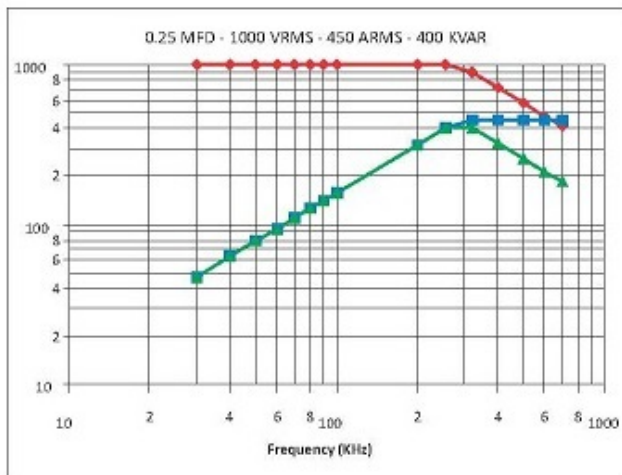
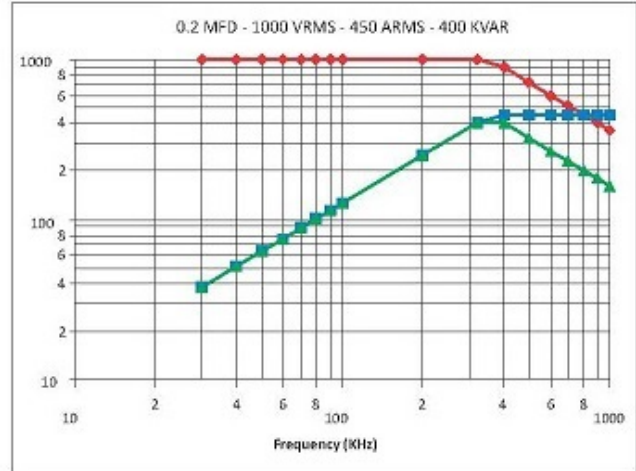
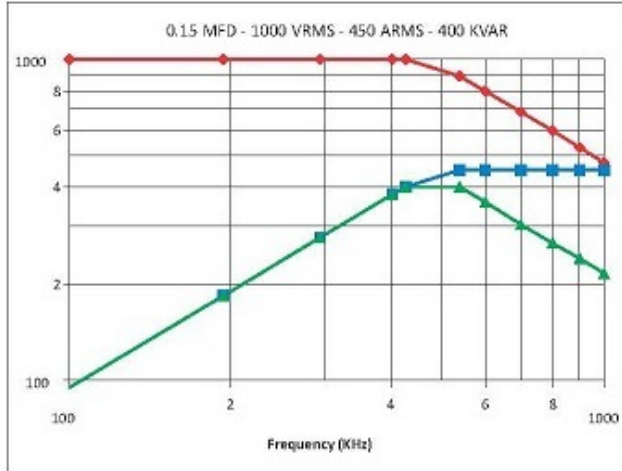

ILLINOIS CAPACITOR

Your Global Source for World-Class Capacitors

© 2013 Illinois Capacitor, Inc.

North America
Tel: 847.675.1760
sales@illcap.com

Asia
Tel: 852.2793 0931
sales@illcap.com.hk

HC4

High Power Resonant Capacitors



Frequency Derating

— Voltage — Current — Power

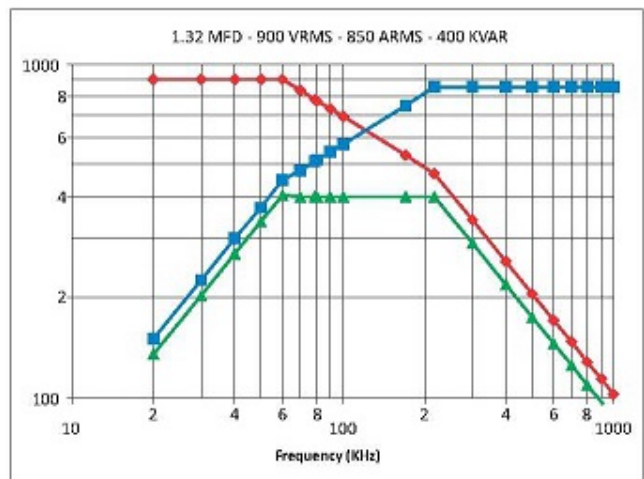
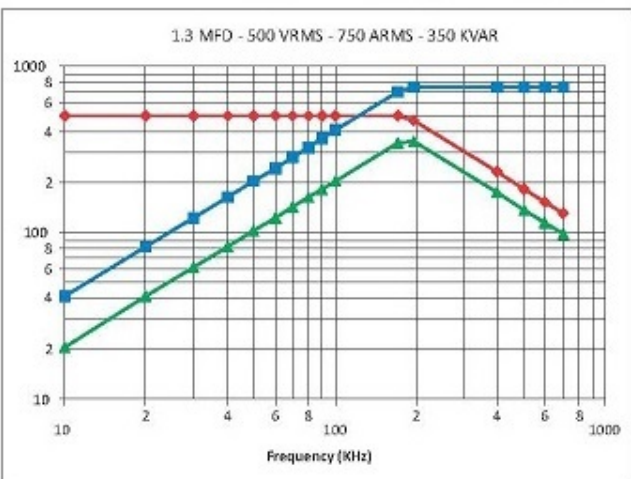
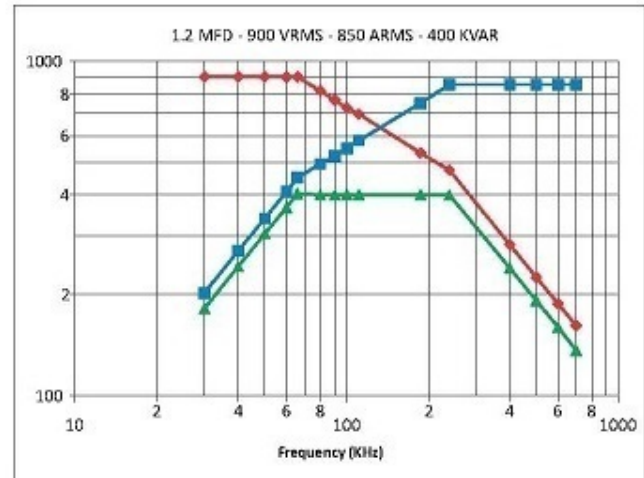
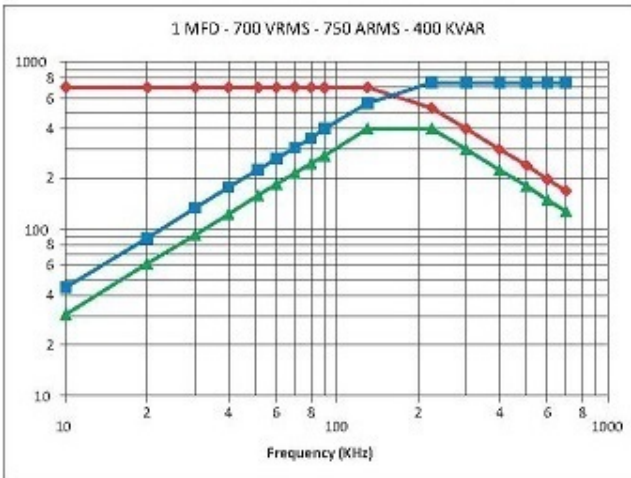
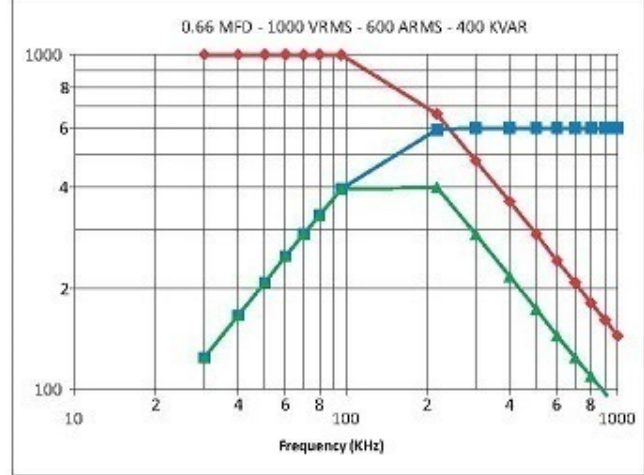
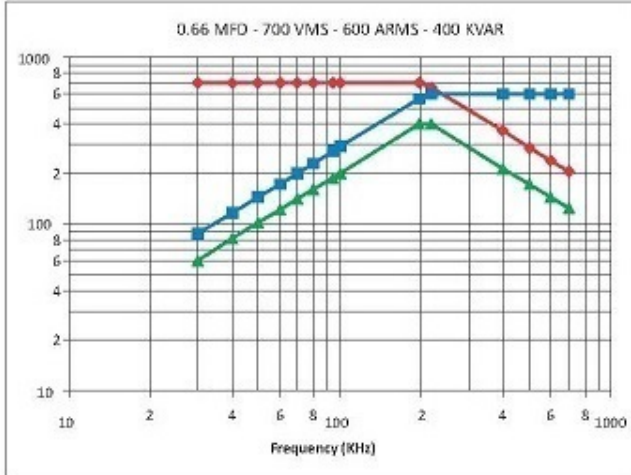

ILLINOIS CAPACITOR

Your Global Source for World-Class Capacitors

© 2013 Illinois Capacitor, Inc.

North America
Tel: 847.675.1760
sales@illcap.com

Asia
Tel: 852.2793 0931
sales@illcap.com.hk

HC4

High Power Resonant Capacitors



Frequency Derating

—●— Voltage —■— Current —▲— Power

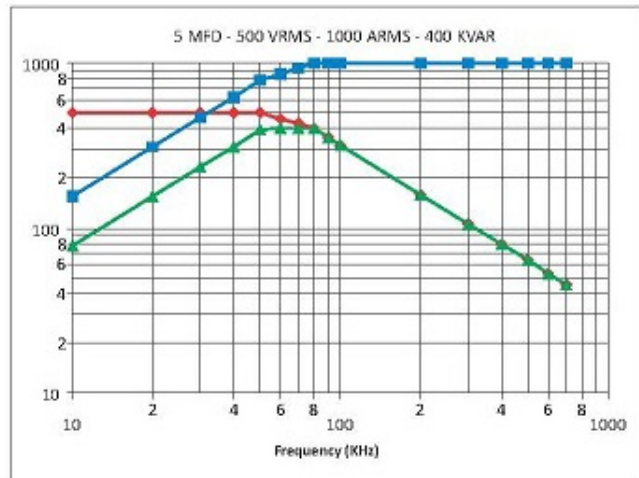
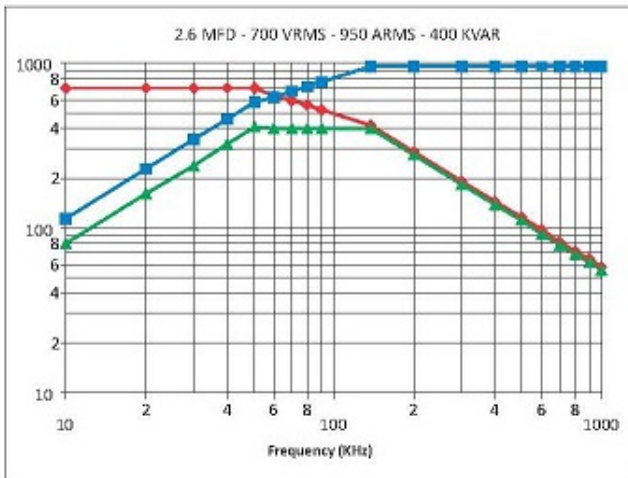
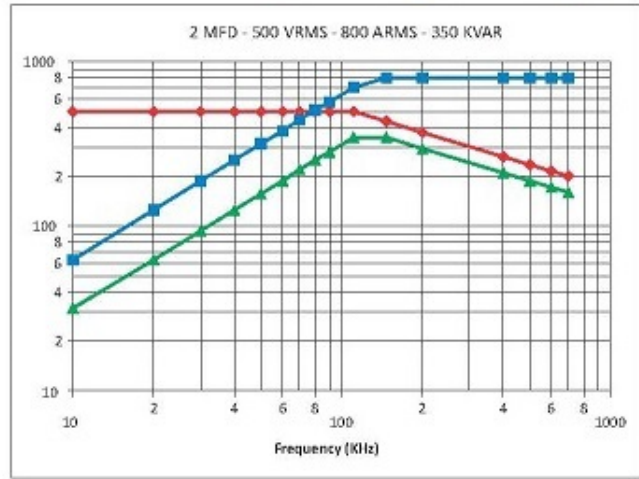
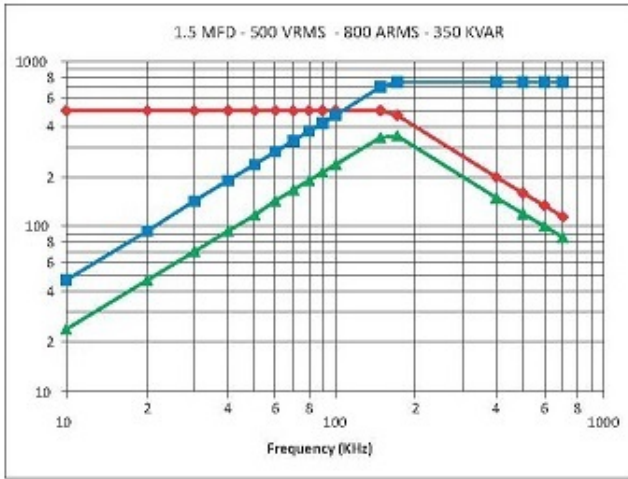

ILLINOIS CAPACITOR

Your Global Source for World-Class Capacitors

© 2013 Illinois Capacitor, Inc.

North America
Tel: 847.675.1760
sales@illcap.com

Asia
Tel: 852.2793 0931
sales@illcap.com.hk