

Acceleration Sensors
Motion Sensors
Infrared Array Sensors
Pressure Sensors

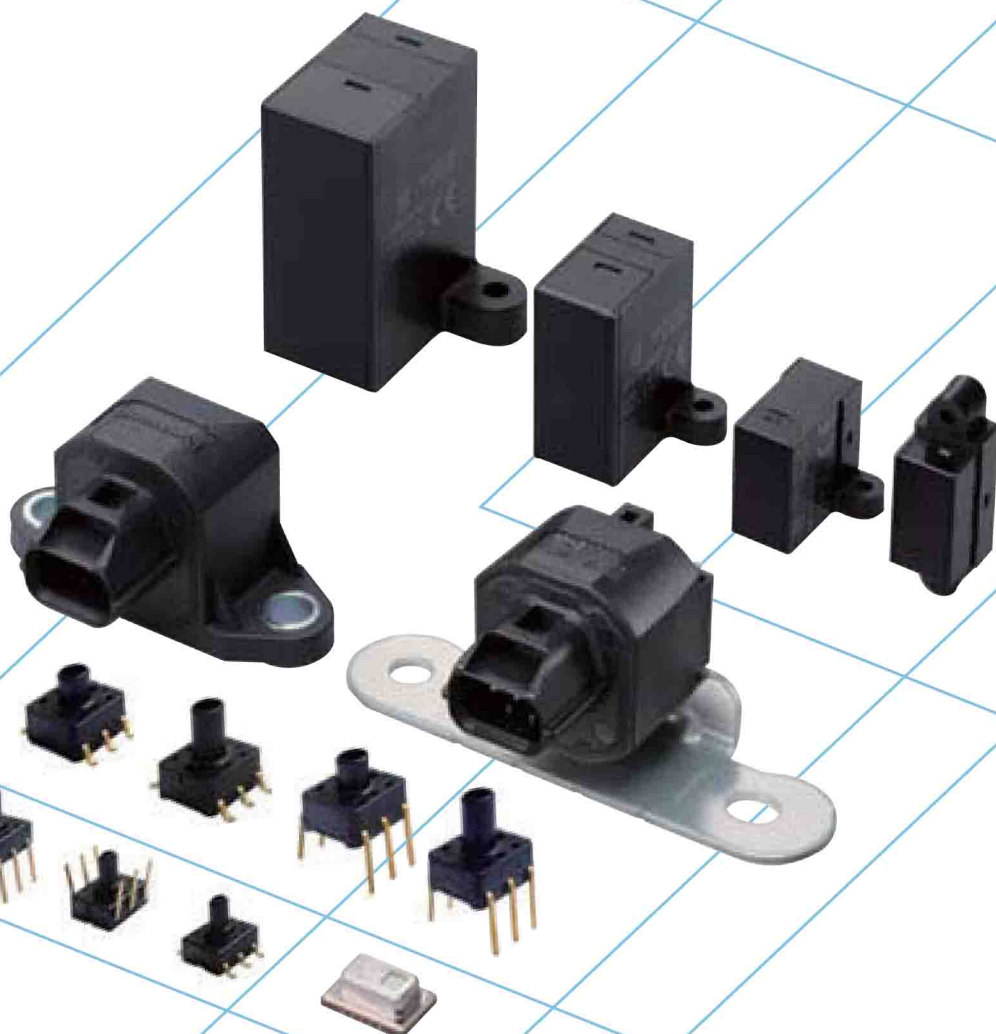

Built-in sensor contributes to energy savings, safety, and comfort.

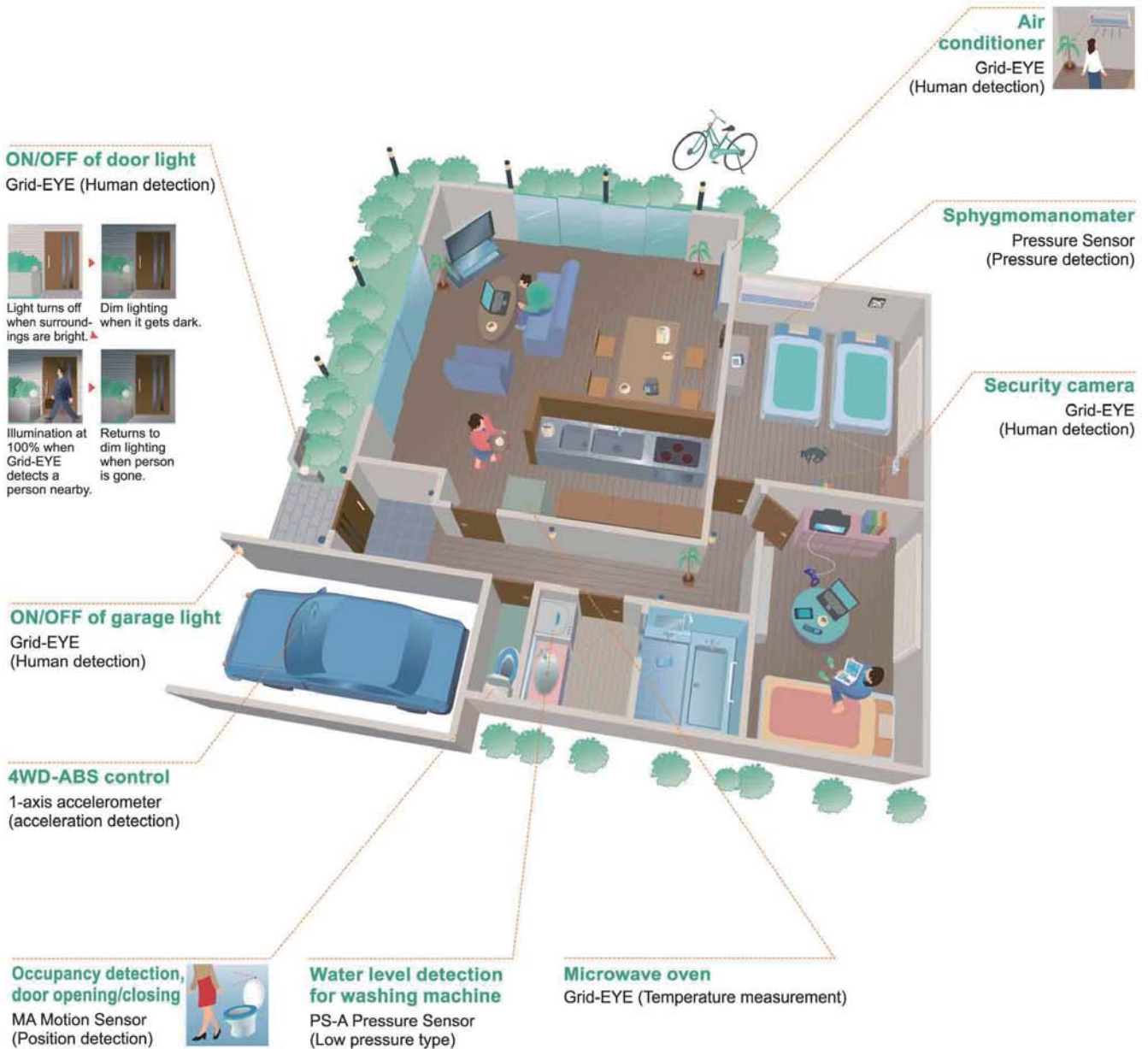

Infrared Array Sensor



1-axis GF1



Infrared Array Sensor



Grid-EYE

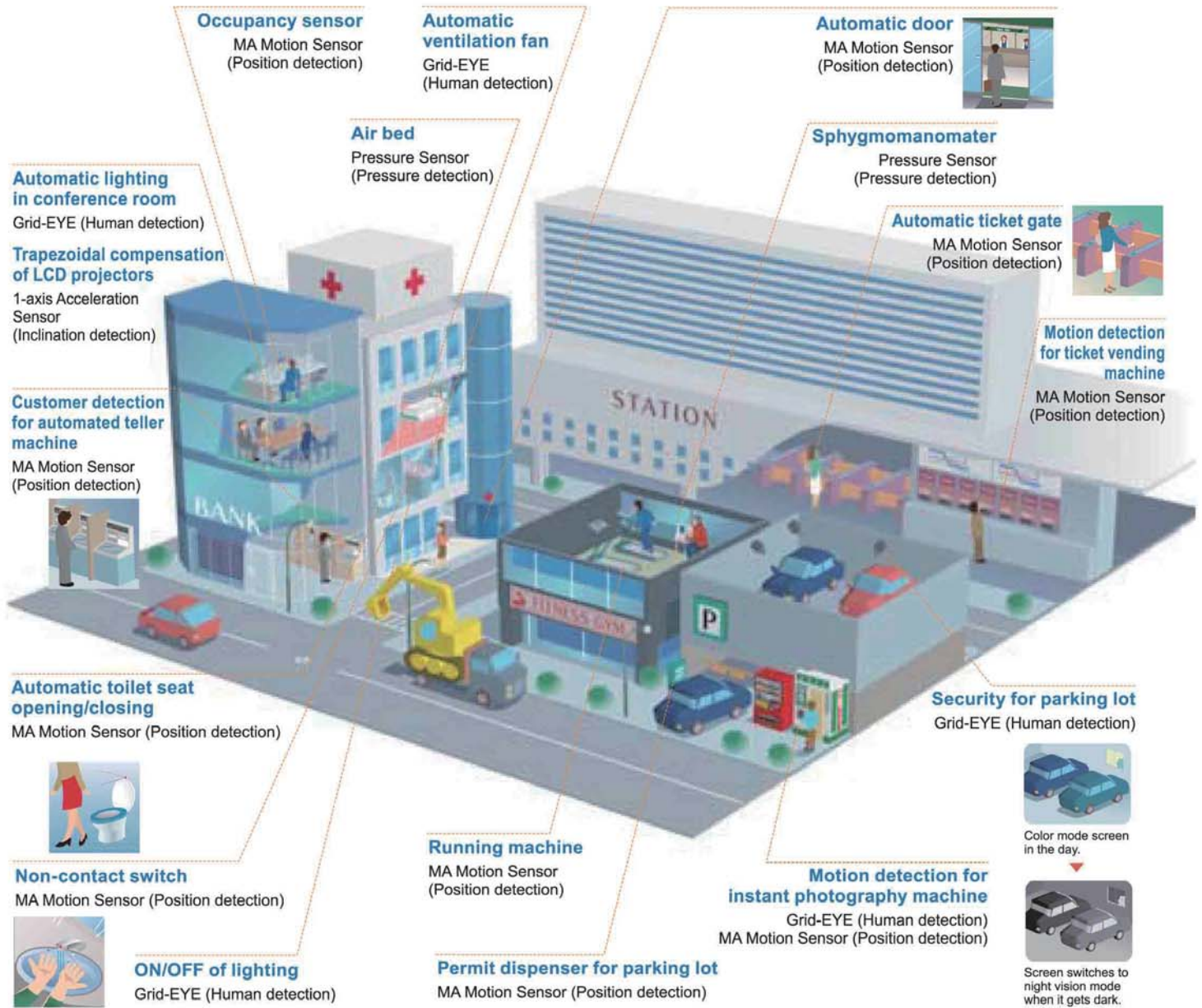

Motion

MA Motion Sensor

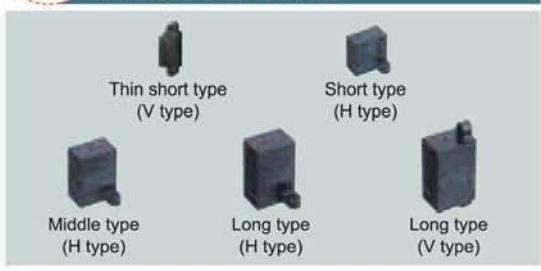

Pressure

Pressure Sensor

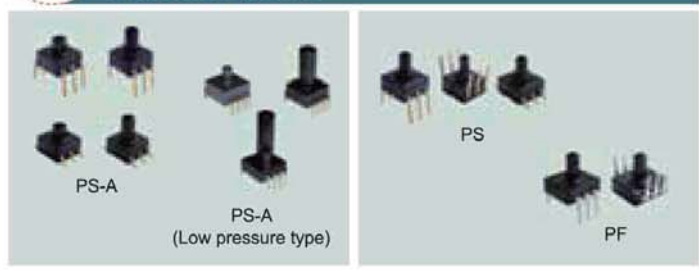

Equipment sensors for improved comfort and convenience, safety and energy conservation

Acceleration

Acceleration Sensors

Acceleration Sensors

Made possible by leading-edge MEMS technology, this acceleration sensor is ideal for automotive and mobile devices.

Product name	Acceleration detection range	Characteristics
1-axis GF1  Direct mount Bracket	$\pm 0.5g$ $\pm 1.2g$	<ul style="list-style-type: none"> ● Fast response, high reliability ● Compact size

Motion

Motion Sensors

Motion Sensors

Motion sensors that always detect your slightest movement

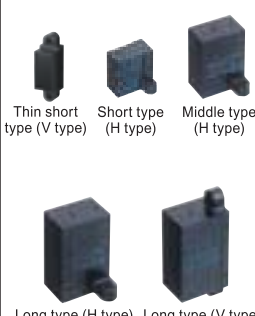
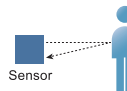
Product name	Detection method	Type	Characteristics				
MA Motion Sensor  Thin short type (V type) Short type (H type) Middle type (H type) Long type (H type) Long type (V type)	Detecting the presence of the human body (or another object) by the reflected beam of LED light from the sensor itself. 	<table border="1"> <tr> <td>Built-in oscillation circuit type</td> <td>Detection distance 5 cm to 200 cm 1.969 inch to 78.74 inch</td> </tr> <tr> <td>External trigger type</td> <td>Detection distance 5 cm to 200 cm 1.969 inch to 78.74 inch</td> </tr> </table>	Built-in oscillation circuit type	Detection distance 5 cm to 200 cm 1.969 inch to 78.74 inch	External trigger type	Detection distance 5 cm to 200 cm 1.969 inch to 78.74 inch	<ul style="list-style-type: none"> ● The sensors are ready for immediate use by simply connecting to a DC power supply. The built-in oscillation circuit removes the need to input a start signal. ● Can be used with a number of different supply voltages. <ol style="list-style-type: none"> 1) 5 V.DC type (4.5 V.DC to 5.5 V.DC) 2) Free-ranging type (5.5 V.DC to 27 V.DC) ● These sensors can be used in adjacent positions and can save energy. ● Can be used with a number of different supply voltages. <ol style="list-style-type: none"> 1) 5 V.DC type (4.5 V.DC to 5.5 V.DC) 2) Free-ranging type (5.5 V.DC to 27 V.DC)
Built-in oscillation circuit type	Detection distance 5 cm to 200 cm 1.969 inch to 78.74 inch						
External trigger type	Detection distance 5 cm to 200 cm 1.969 inch to 78.74 inch						



Infrared Array Sensors



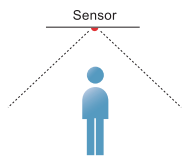







High Precision Infrared Array Sensor based on Advanced MEMS Technology

Product name	Detection method	Type	Characteristics
Grid-EYE 	Detecting the heat (infrared rays) of the human body and other objects. 	Operating voltage 3.3 V.DC 5.0 V.DC Amplification factor High performance type High gain High performance type Low gain	<ul style="list-style-type: none"> ● Temperature detection achieved on a two dimensional area with 8 × 8 (64) pixels. ● Digital output ● Miniature SMD package



Pressure Sensors

A wide range of rated pressure, including minute pressures

Product name	Pressure medium	Type (*Without glass base type)	Terminal direction	Pressure inlet hole length	Characteristics
PS-A Pressure Sensor 	Air	Rated pressure ±100, -100, 25, 50, 100, 200, 500, 1,000 *40kPa	Opposite the pressure inlet direction  	 	<ul style="list-style-type: none"> ● Compact pressure sensor with built-in amplification and temperature compensation circuit
		<Low pressure type> 6kPa	(SMD terminal) 	 	
PS Pressure Sensor PF Pressure Sensor 	Air	Rated pressure 4.9, 34.3, 49.0, 98.1, 196.1, 343.2, 490.3, 833.6, 980.7 kPa	Opposite the pressure inlet direction  	—	<ul style="list-style-type: none"> ● Ultra-miniature Base area 7.2 (W) x 7.2 (D) mm .283 (W) x .283 (D) inch ● A wide range of rated pressure, including a minute pressure.
		*40kPa 98.1, 980.7kPa (PS only)	Bridge resistance 5kΩ 3.3kΩ		

Electrostatic capacitance detection sensor 1-axis acceleration sensor

GF1

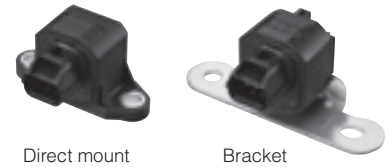

Features

- High precision, High reliability : Superior offset voltage temperature characteristics (± 33 mg (Typ.))
- High sensitivity : 1.333 to 3.0 V/g
- Compact size : 58×36.5×33 mm 2.283×1.437×1.299 inch (Direct-mount type)
- RoHS compliant

Typical Applications

- Automobiles : 4WD-ABS control, neutral control, idling stop system and suspension control
- Special vehicles : Inclination detection (for enhanced safety and operating efficiency) of agricultural machine, construction machine and welfare vehicles
- Photovoltaic generation : Sun tracking panels

Ordering Information

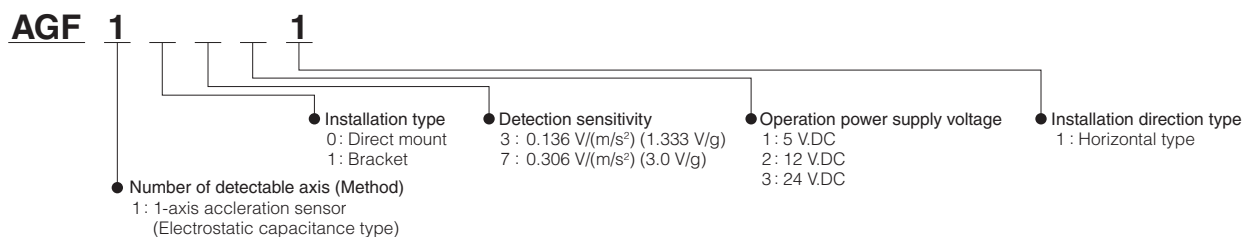

Product Types

Carton : 80 pcs. (Bracket), 150 pcs. (Direct mount)

Product name	Operation power supply voltage	Acceleration detection range	Detection sensitivity	Installation type	Part number
1-axis acceleration sensor GF1	5 V.DC	± 11.76 m/s ² (± 1.2 g)	0.136 V/(m/s ²) (1.333 V/g)	Bracket	AGF11311
		± 4.9 m/s ² (± 0.5 g)	0.306 V/(m/s ²) (3.0 V/g)	Direct mount	AGF10711
	12 V.DC	± 11.76 m/s ² (± 1.2 g)	0.136 V/(m/s ²) (1.333 V/g)	Direct mount	AGF10321
		± 4.9 m/s ² (± 0.5 g)	0.306 V/(m/s ²) (3.0 V/g)	Direct mount	AGF10721
	24 V.DC	± 11.76 m/s ² (± 1.2 g)	0.136 V/(m/s ²) (1.333 V/g)	Direct mount	AGF10331
		± 4.9 m/s ² (± 0.5 g)	0.306 V/(m/s ²) (3.0 V/g)	Direct mount	AGF10731

Absolute Maximum Ratings

Product name	Unit	Absolute maximum ratings			Remarks
		AGF1□□11 (Power supply: 5 V.DC type)	AGF1□□21 (Power supply: 12 V.DC type)	AGF1□□31 (Power supply: 24 V.DC type)	
Maximum allowable voltage	V.DC	7	16	30	Max. Ta=25 °C 68 °F
Maximum applied acceleration	g	AGF1□3□1	15		Max.
		AGF1□7□1	5		Max.
Storage temperature range	°C °F	-30 to 85 -22 to 185			
Operation temperature range	°C °F	-30 to 85 -22 to 185			
Anti-shock characteristic	g	5,000			Max.
Grade of protection *		IP67			

Note : * Performance when matching connector is connected.

Electrical Characteristics

● AGF1□3□1 (Sensitivity : 1.333 V/g type)

Item	Unit	Performance			Remarks
		AGF1□□11 (Power supply: 5 V.DC type)	AGF1□□21 (Power supply: 12 V.DC type)	AGF1□□31 (Power supply: 24 V.DC type)	
Operation power supply voltage	V.DC	5 V.DC±5 %	12 V.DC±10 %	24 V.DC±10 %	-30 °C to +85 °C -22 °F to +185 °F
Acceleration detection range *1	g (°)	±1.2 (90)			
Current consumption	mA	10	15		0g, Ta=20 °C 68 °F, Max.
Sensitivity	V/g	1.333±3 %			-30 °C to +85 °C -22 °F to +185 °F
Offset voltage (0g)	V	2.5±0.1			Ta=20 °C 68 °F
Offset voltage temperature characteristic	V	±0.093			-30 °C to +85 °C -22 °F to +185 °F
Other axis sensitivity	%	±5			Ta=20 °C 68 °F
Non-linearity *2	%FS	±1			Ta=20 °C 68 °F
Frequency response	Hz	10 to 15			-3 dB point
Clamping voltage VH *3	V	4.5	-	-	Typ.
Clamping voltage VL *3	V	0.5	-	-	Typ.

● AGF1□7□1 (Sensitivity : 3.0 V/g type)

Item	Unit	Performance			Remarks
		AGF1□□11 (Power supply: 5 V.DC type)	AGF1□□21 (Power supply: 12 V.DC type)	AGF1□□31 (Power supply: 24 V.DC type)	
Operation power supply voltage	V.DC	5 V.DC±5 %	12 V.DC±10 %	24 V.DC±10 %	-30 °C to +85 °C -22 °F to +185 °F
Acceleration detection range *1	g (°)	±0.5 (30)			
Current consumption	mA	10	15		0g, Ta=20 °C 68 °F, Max.
Sensitivity	V/g	3.0±3 %			-30 °C to +85 °C -22 °F to +185 °F
Offset voltage (0g)	V	2.5±0.1			Ta=20 °C 68 °F
Offset voltage temperature characteristic	V	±0.21			-30 °C to +85 °C -22 °F to +185 °F
Other axis sensitivity	%	±5			Ta=20 °C 68 °F
Non-linearity *2	%FS	±1			Ta=20 °C 68 °F
Frequency response	Hz	10 to 15			-3 dB point
Clamping voltage VH *3	V	4.5	-	-	Typ.
Clamping voltage VL *3	V	0.5	-	-	Typ.

Note : *1 The acceleration unit "g" means 9.8 m/s².

*2 Maximum error from linear output that connects +1.2 g and -1.2 g output. (AGF1□3□1)

Maximum error from linear output that connects +0.5 g and -0.5 g output. (AGF1□7□1)

*3 The 12 V and 24 V.DC operating power supply voltage types can also be compatible with the clamping voltage. Please consult us.

Reference Data

1. Output characteristics

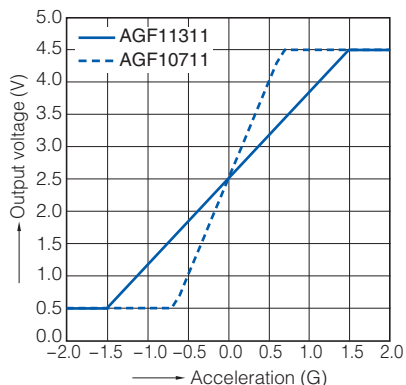

2. Inclination angle - Output voltage characteristics

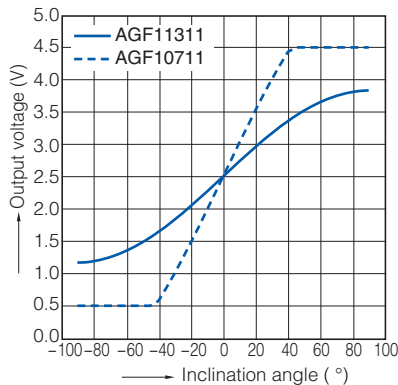

3. Sensitivity temperature characteristics

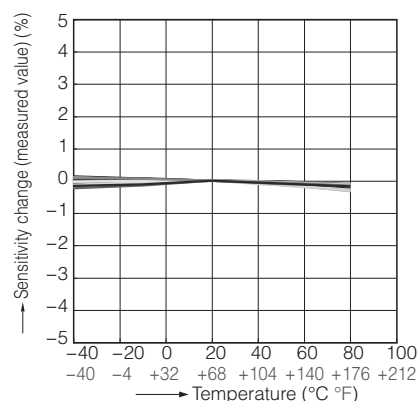

4. Offset voltage temperature characteristics

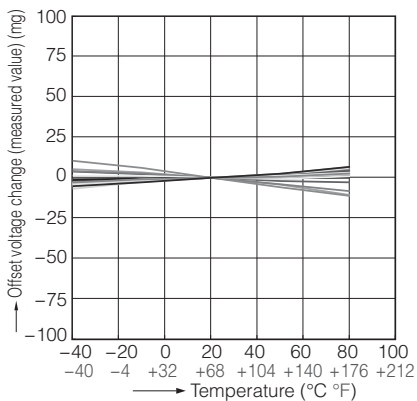

5. Frequency characteristics

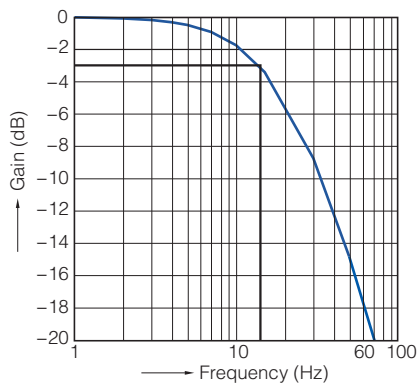

Dimensions

The CAD data of the products with a **CAD Data** mark can be downloaded from: <http://industrial.panasonic.com/>

● Direct mount (AGF10□□1)

CAD Data

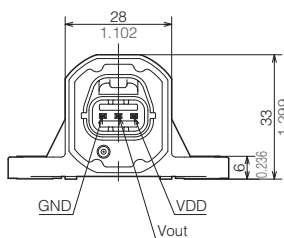
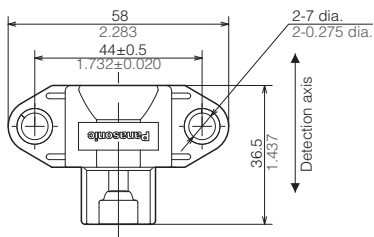

Matching connector:
Manufacturing company : Yazaki Corporation
Housing : 7283-8730-30

unit : mm inch

● Bracket (AGF11□□1)

CAD Data

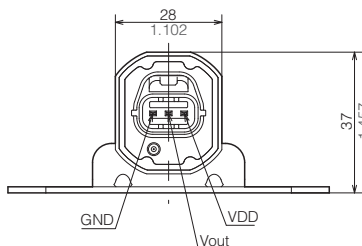
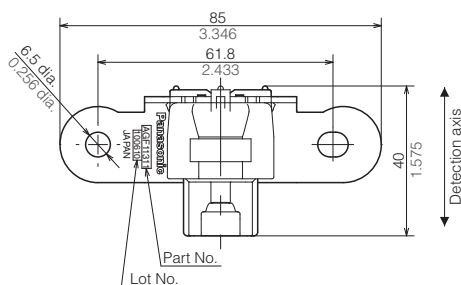
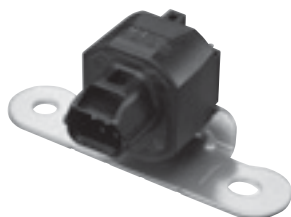

Matching connector :
Manufacturing company : Yazaki Corporation
Housing : 7283-8730-30

unit : mm inch

Wiring Diagram

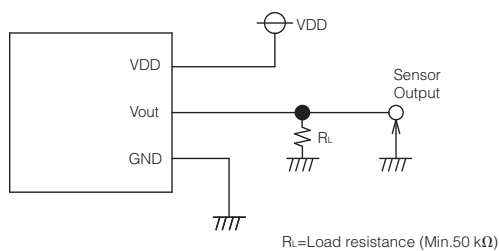

NOTES

■ Before using the products, carefully check the quality under actual use conditions to enhance stability.

■ Wire connection

Correctly wire as in the connection diagram. Reverse connection may damage the product and degrade the performance.

■ Cleaning

Avoid ultrasonic cleaning as this may cause disconnection of the wire.

■ Environment

- Avoid use and storage in the corrosive gas (organic solvent, sulfurous acid and hydrogen sulfide gases) which negatively affects the product.
- Use surge absorbers as applying the external surge voltage may damage the internal circuit.
- Malfunction may occur near electric noises from static electricity, lightning, broadcast or amateur radio stations and mobile phones.
- Avoid use in an environment where these products cause dew condensation. When water attached to the sensor chip freezes, the sensor output may be fluctuated or damaged.
- Do not apply high-frequency oscillation, such as ultrasonic waves, to the product.
- Do not use in direct sunlight or other comparable light.

■ Other precautions

These specifications are for individual components. Before use, carefully check the performance and quality under actual use conditions to enhance stability.

- Misconnection and the wrong range of acceleration detection may invite the risk of accidents.
- Avoid use beyond the specified acceleration range, as such use may damage the product.
- Carefully handle as static electricity may damage the product.

■ Special notes

We exert maximum efforts for quality control of the product, Please mind also about the following.

- 1) To prevent occurrence of unexpected circumstances, please inform us of the specifications of your product, customers, use conditions and details of the attachment position.
- 2) Have sufficient margin values of driving/performance guarantee described in the specifications and apply safety measures with double circuits, if serious effects on human lives or property are predicted due to a quality failure of the product. Those countermeasures are also for the product liability.
- 3) A warranty period is one year after the delivery to your company. Quality assurance is limited to the items and the scopes described in the specifications.

If a defect is found after the delivery, we will promptly provide a replacement or change/repair the defect part at the place of delivery in good faith. Exceptions are below.

- Damages by a failure or a defect which arose after the delivery.
- After the delivery, when storing and transporting, if conditions other than conditions in the specifications are applied to the product.
- Damages by unforeseen phenomenon which cannot be predicted with the technologies available at the time of delivery.
- Damages by natural and anthropogenic disasters, such as earthquake, flood, fire and war, which are beyond our reasonable control.

Active infrared (area reflective) human detection sensor MA MOTION SENSOR

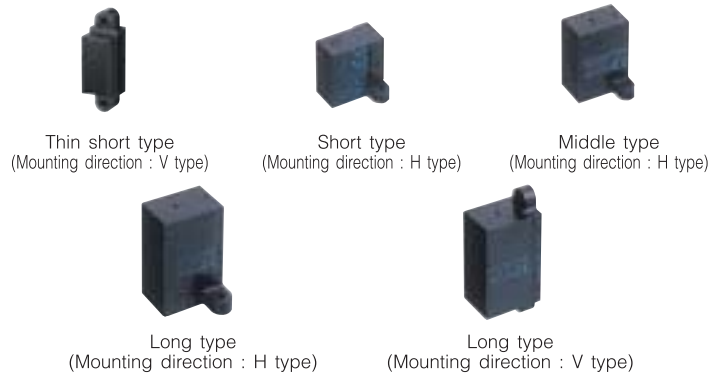

Features

- Reliable detection hardly influenced by reflectivity of targeted objects
- Ready-to-use with DC power source (built-in oscillation circuit type)
- Capability to adjoin sensors (External triggering type)
- RoHS compliant

Typical applications

- Equipment around water: automatic lighting of wash-units, toilets, automatic flush
- Stores and financial markets: automatic doors, lighting, ATM, visitor sensors
- Amusement equipment: seating detection for pachinko machines, game displays
- Medical equipment markets: noncontact switches

Ordering information

AM

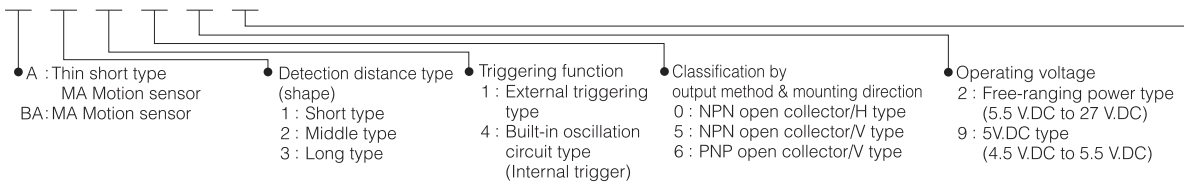

● Rated detection distance

Unit : cm inch

Part No. Type	02	03	04	05	06	07	08 (Middle type does not need 08)	09	10 (Short type does not need 10)	11	12	13	14	15	16	17	18	19	20 (Long type does not need 20)
Thin short type	-	-	-	5 1.969	-	-	-	-	10 3.937	-	-	-	-	15 5.906	-	-	-	-	-
Short type	-	-	-	5 1.969	6 2.362	7 2.756	8 3.150	9 3.543	10 3.937	-	-	-	-	-	-	-	-	-	-
Middle type	20 7.874	30 11.811	40 15.748	50 19.685	60 23.622	70 27.559	80 31.496	-	-	-	-	-	-	-	-	-	-	-	-
Long type	-	30 11.811	40 15.748	50 19.685	60 23.622	70 27.559	80 31.496	90 35.443	100 39.37	110 43.307	120 47.244	130 51.181	140 55.118	150 59.055	160 62.992	170 66.929	180 70.866	190 74.803	200 78.74

Product types

- Detection distance type (distance limited)
 - 1) Thin short type (V type)

Standard packing: Carton: 20 pcs.; Case: 200 pcs.

Operating voltage	Output method	Rated detection distance	Built-in oscillation circuit type	External triggering type
			Part No.	Part No.
4.5 V.DC to 5.5 V.DC	NPN open collector output	5 cm 1.969 inch	AMA145905	AMA115905
		10 cm 3.937 inch	AMA1459	AMA1159
		15 cm 5.906 inch	AMA145915	AMA115915
	PNP open collector output	5 cm 1.969 inch	AMA146905	AMA116905
		10 cm 3.937 inch	AMA1469	AMA1169
		15 cm 5.906 inch	AMA146915	AMA116915

Note: If using multiple sensors adjacently or reducing power consumption, contact us for the optimal external trigger type.

- 2) Short type (H type)

Standard packing: Carton: 20 pcs.; Case: 200 pcs.

Rated operating voltage	Rated detection distance	Mounting direction : H type	
		Short type	
		Built-in oscillation circuit type	External triggering type
		Part No.	Part No.
4.5 V.DC to 5.5 V.DC	5 cm 1.969 inch	AMBA140905	AMBA110905
	6 cm 2.362 inch	AMBA140906	AMBA110906
	7 cm 2.756 inch	AMBA140907	AMBA110907
	8 cm 3.150 inch	AMBA140908	AMBA110908
	9 cm 3.543 inch	AMBA140909	AMBA110909
	10 cm 3.937 inch	AMBA1409	AMBA1109
5.5 V.DC to 27 V.DC	5 cm 1.969 inch	AMBA140205	AMBA110205
	6 cm 2.362 inch	AMBA140206	AMBA110206
	7 cm 2.756 inch	AMBA140207	AMBA110207
	8 cm 3.150 inch	AMBA140208	AMBA110208
	9 cm 3.543 inch	AMBA140209	AMBA110209
	10 cm 3.937 inch	AMBA1402	AMBA1102

Note: If using multiple sensors adjacently or reducing power consumption, contact us for the optimal external trigger type.

- 3) Middle type (H type)

Standard packing: Carton: 20 pcs.; Case: 200 pcs.

Rated operating voltage	Rated detection distance	Mounting direction : H type	
		Middle type	
		Built-in oscillation circuit type	External triggering type
		Part No.	Part No.
4.5 V.DC to 5.5 V.DC	20 cm 7.874 inch	AMBA240902	AMBA210902
	30 cm 11.811 inch	AMBA240903	AMBA210903
	40 cm 15.748 inch	AMBA240904	AMBA210904
	50 cm 19.685 inch	AMBA240905	AMBA210905
	60 cm 23.622 inch	AMBA240906	AMBA210906
	70 cm 27.559 inch	AMBA240907	AMBA210907
	80 cm 31.496 inch	AMBA2409	AMBA2109
5.5 V.DC to 27 V.DC	20 cm 7.874 inch	AMBA240202	AMBA210202
	30 cm 11.811 inch	AMBA240203	AMBA210203
	40 cm 15.748 inch	AMBA240204	AMBA210204
	50 cm 19.685 inch	AMBA240205	AMBA210205
	60 cm 23.622 inch	AMBA240206	AMBA210206
	70 cm 27.559 inch	AMBA240207	AMBA210207
	80 cm 31.496 inch	AMBA2402	AMBA2102

Note: If using multiple sensors adjacently or reducing power consumption, contact us for the optimal external trigger type.

4) Long type

Standard packing: Carton: 20 pcs.; Case: 200 pcs.

Rated operating voltage	Rated detection distance	Mounting direction : H type		Mounting direction: V type	
		Long type			
		Built-in oscillation circuit type	External triggering type	Built-in oscillation circuit type	External triggering type
		Part No.	Part No.	Part No.	Part No.
4.5 V.DC to 5.5 V.DC	30 cm 11.811 inch	AMBA340903	AMBA310903	AMBA345903	AMBA315903
	40 cm 15.748 inch	AMBA340904	AMBA310904	AMBA345904	AMBA315904
	50 cm 19.685 inch	AMBA340905	AMBA310905	AMBA345905	AMBA315905
	60 cm 23.622 inch	AMBA340906	AMBA310906	AMBA345906	AMBA315906
	70 cm 27.559 inch	AMBA340907	AMBA310907	AMBA345907	AMBA315907
	80 cm 31.496 inch	AMBA340908	AMBA310908	AMBA345908	AMBA315908
	90 cm 35.433 inch	AMBA340909	AMBA310909	AMBA345909	AMBA315909
	100 cm 39.370 inch	AMBA340910	AMBA310910	AMBA345910	AMBA315910
	110 cm 43.307 inch	AMBA340911	AMBA310911	AMBA345911	AMBA315911
	120 cm 47.244 inch	AMBA340912	AMBA310912	AMBA345912	AMBA315912
	130 cm 51.181 inch	AMBA340913	AMBA310913	AMBA345913	AMBA315913
	140 cm 55.118 inch	AMBA340914	AMBA310914	AMBA345914	AMBA315914
	150 cm 59.055 inch	AMBA340915	AMBA310915	AMBA345915	AMBA315915
	160 cm 62.992 inch	AMBA340916	AMBA310916	AMBA345916	AMBA315916
	170 cm 66.929 inch	AMBA340917	AMBA310917	AMBA345917	AMBA315917
	180 cm 70.866 inch	AMBA340918	AMBA310918	AMBA345918	AMBA315918
190 cm 74.803 inch	AMBA340919	AMBA310919	AMBA345919	AMBA315919	
200 cm 78.740 inch	AMBA3409	AMBA3109	AMBA3459	AMBA3159	
5.5 V.DC to 27 V.DC	30 cm 11.811 inch	AMBA340203	AMBA310203	AMBA345203	AMBA315203
	40 cm 15.748 inch	AMBA340204	AMBA310204	AMBA345204	AMBA315204
	50 cm 19.685 inch	AMBA340205	AMBA310205	AMBA345205	AMBA315205
	60 cm 23.622 inch	AMBA340206	AMBA310206	AMBA345206	AMBA315206
	70 cm 27.559 inch	AMBA340207	AMBA310207	AMBA345207	AMBA315207
	80 cm 31.496 inch	AMBA340208	AMBA310208	AMBA345208	AMBA315208
	90 cm 35.433 inch	AMBA340209	AMBA310209	AMBA345209	AMBA315209
	100 cm 39.370 inch	AMBA340210	AMBA310210	AMBA345210	AMBA315210
	110 cm 43.307 inch	AMBA340211	AMBA310211	AMBA345211	AMBA315211
	120 cm 47.244 inch	AMBA340212	AMBA310212	AMBA345212	AMBA315212
	130 cm 51.181 inch	AMBA340213	AMBA310213	AMBA345213	AMBA315213
	140 cm 55.118 inch	AMBA340214	AMBA310214	AMBA345214	AMBA315214
	150 cm 59.055 inch	AMBA340215	AMBA310215	AMBA345215	AMBA315215
	160 cm 62.992 inch	AMBA340216	AMBA310216	AMBA345216	AMBA315216
	170 cm 66.929 inch	AMBA340217	AMBA310217	AMBA345217	AMBA315217
	180 cm 70.866 inch	AMBA340218	AMBA310218	AMBA345218	AMBA315218
190 cm 74.803 inch	AMBA340219	AMBA310219	AMBA345219	AMBA315219	
200 cm 78.740 inch	AMBA3402	AMBA3102	AMBA3452	AMBA3152	

Note: If using multiple sensors adjacently or reducing power consumption, contact us for the optimal external trigger type.

Rating

● Detection performance

1) Thin short type (Measuring conditions: ambient temp. : 25 °C 77 °F; operating voltage : 5 V.DC)

Items		Unit	Thin short type			Measured conditions			
			cm	inch	cm		inch	cm	inch
Rated detection distance	Minimum	mm inch	45	1.772	90	3.543	135	5.315	with a standard reflection board *1
	Typical		50	1.969	100	3.937	150	5.906	
	Maximum		55	2.165	110	4.331	165	6.496	
Measuring tolerance		Typical	%	10	25	35	Reflection rate: 90 % to 18 %		
Usable ambient brightness (Resistance to ambient light) *2	Brightness of sensor surface	Maximum	lx	30,000			See the drawing (Fig. 1) on the Brightness next page.		
	Brightness of reflection surface	Maximum		24,000					

Notes : *1. Ambient brightness: 500 lx

*2. Prevent direct light (within 30 ° against the optical axis of the sensor) from entering into the sensor.

2) Short type (Measuring conditions : ambient temp.: 25 °C 77 °F; operating voltage: 5 V.DC type 5 V.DC, Free-ranging power type 24 V.DC)

Items		Unit		Short type *1					Measured conditions	
		cm	inch	5	6	7	8	9		10
Rated detection distance	Minimum	mm	inch	45	54	63	72	81	90	with a standard reflection board
	Typical			1.772	2.126	2.480	2.835	3.189	3.543	
	Maximum			50	60	70	80	90	100	
Measuring tolerance		Typical	%	10		15	20		25	Reflection rate: 90 % to 18 %
Usable ambient brightness (Resistance to ambient light) *2	Brightness of sensor surface	Maximum	lx	30,000					See the drawing (Fig. 1) on the next page.	
	Brightness of reflection surface	Maximum		24,000						

Notes : *1. After the order receipt, the average rated detecting distance can be increased to max 15 cm 5.906 inch. Please consult us.

*2. Prevent direct light (within 30 ° against the optical axis of the sensor) from entering into the sensor.

3) Middle type (Measuring conditions: ambient temp.: 25 °C 77 °F; operating voltage: 5 V.DC type 5 V.DC, Free-ranging power type 24 V.DC)

Items		Unit		Middle type *1					Measured conditions		
		cm	inch	20	30	40	50	60		70	80
Rated detection distance	Minimum	mm	inch	190	285	380	475	570	665	760	with a standard reflection board
	Typical			7.480	11.220	14.961	18.701	22.441	26.181	29.921	
	Maximum			200	300	400	500	600	700	800	
Measuring tolerance		Typical	%	3		5		10		Reflection rate: 90 % to 18 %	
Usable ambient brightness (Resistance to ambient light) *2	Brightness of sensor surface	Maximum	lx	30,000					See the drawing (Fig. 1) on the next page.		
	Brightness of reflection surface	Maximum		24,000							

Notes : *1. After the order receipt, the average rated detecting distance can be increased to max 110 cm 43.307 inch. Please consult us.

*2. Prevent direct light (within 30 ° against the optical axis of the sensor) from entering into the sensor.

4) Long type (Measuring conditions: ambient temp.: 25 °C 77 °F; operating voltage: 5 V.DC type 5 V.DC, Free-ranging power type 24 V.DC)

Items		Unit		Long type							Measured conditions		
		cm	inch	30	40	50	60	70	80	90		100	110
Rated detection distance	Minimum	mm	inch	285	380	475	570	665	760	855	950	1045	with a standard reflection board
	Typical			11.220	14.961	18.701	22.441	26.181	29.921	33.661	37.402	41.142	
	Maximum			300	400	500	600	700	800	900	1000	1100	
Measuring tolerance		Typical	%	3				5			Reflection rate: 90 % to 18 %		
Usable ambient brightness (Resistance to ambient light) *	Brightness of sensor surface	Maximum	lx	30,000							See the drawing (Fig. 1) on the next page.		
	Brightness of reflection surface	Maximum		24,000									

Items		Unit		Long type							Measured conditions		
		cm	inch	120	130	140	150	160	170	180		190	200
Rated detection distance	Minimum	mm	inch	1140	1235	1330	1425	1520	1615	1710	1805	1900	with a standard reflection board
	Typical			44.882	48.622	52.362	56.102	59.842	63.583	67.323	71.063	74.803	
	Maximum			1200	1300	1400	1500	1600	1700	1800	1900	2000	
Measuring tolerance		Typical	%	5	10			15				Reflection rate: 90 % to 18 %	
Usable ambient brightness (Resistance to ambient light) *	Brightness of sensor surface	Maximum	lx	30,000							See the drawing (Fig. 1) on the next page.		
	Brightness of reflection surface	Maximum		24,000									

Notes : * Prevent direct light (within 30 ° against the optical axis of the sensor) from entering into the sensor.

- For thin short type:
Standard reflection board : 150 mm 5.906 inch square area, 90% reflection rate.
- For short type:
Standard reflection board: 100 mm 3.937 inch square area, 90% reflection rate.
- For middle type:
Standard reflection board: 200 mm 7.874 inch square area, 90% reflection rate.
- For long type:
Standard reflection board: 500 mm 19.685 inch square area, 90% reflection rate.

Notes : 1. Detecting an object within the maximum preset detection distance.

$$2. \text{Distance deviation} = \frac{a-b}{a} \times 100 (\%)$$

(a: detection distance of detection target with reflectance of 90 %.
b: detection distance of standard detection target with reflectance of 18 %.)

<Fig. 1>
[Brightness of sensor surface]

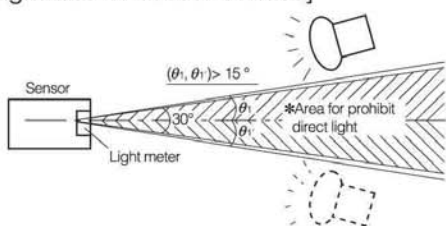

Notes : If sunlight or strobe/inverter light (including the regular reflection light from glasses and mirrors) directly enters from the inhibition area, those lights may cause malfunction of the sensor.

[Brightness of reflection surface]

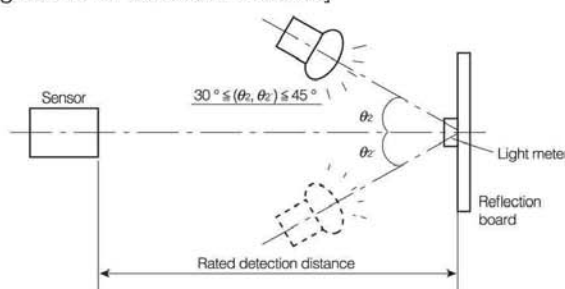

Absolute maximum rating

● Measuring condition: ambient temp.: 25 °C 77 °F

Items	Absolute maximum rating			
	Built-in oscillation circuit type		External triggering type	
	5 V.DC type	Free-ranging power type	5 V.DC type	Free-ranging power type
Power supply voltage	-0.3 V.DC to 6.0 V.DC	-0.3 V.DC to 30 V.DC	-0.3 V.DC to 6.0 V.DC	-0.3 V.DC to 30 V.DC
Output dielectric strength	30 V.DC		30 V.DC	
Output flow current	100 mA		10 mA*	
Usable ambient temperature	-25 °C to +75 °C +5 °F to +131 °F (No freezing)		-25 °C to +75 °C +5 °F to +131 °F (No freezing)	
Storage temperature	-30 °C to +85 °C -4 °F to +176 °F		-30 °C to +85 °C -4 °F to +176 °F	

Notes : * Thin short type is only: 100 mA

Electrical characteristics

● Measuring conditions : ambient temp.: 25 °C 77 °F, operating voltage: 5 V.DC type, free-ranging power type 24 V.DC

1) Built-in oscillation circuit type

Items	Symbol	Thin short type*		Short type	Middle type	Long type	Measured conditions	
		NPN output type	PNP output type					
Rated operating voltage	Minimum	5.0 V.DC type : 4.5V.DC / Free-ranging power type : 5.5 V.DC						
	Typical	-						
	Maximum	5.0 V.DC type : 5.5 V.DC /Free-ranging power type : 27 V.DC						
Average current consumption (I _{out} =0 mA)	No detection	I _t	-		-			
			Typical	4.5 mA	5.0 V.DC type : 4.5 mA Free-ranging power type : 5.6 mA			
			Maximum	6.2 mA	5.0 V.DC type : 6.2 mA Free-ranging power type : 7.8 mA			
	Detection	I _t	-		-			
			Typical	7.0 mA	11.0 mA	5.0 V.DC type : 7.0 mA Free-ranging power type : 9.1 mA		
			Maximum	11.2 mA	15.2 mA	5.0 V.DC type : 11.2 mA Free-ranging power type : 14.2 mA		
Measuring cycle	Typical	T	8 ms/cycle					
Output characteristics	Remain voltage	Maximum	V _r	1.0 V.DC	1.2 V.DC	1.0 V.DC	I _t =100 mA	
	Leakage current	Maximum	I _l	5 μA		3 μA	V=30 V.DC	

Notes : * The thin short type is only available for 5 V.DC.

2) External triggering type (trigger conditions: trigger pulse width = 20 μs and trigger synchronization = 5 ms)

Items		Symbol	Thin short type*1		Short type	Middle type	Long type	Measured conditions		
			NPN output type	PNP output type						
Rated operating voltage		Minimum	5.0 V.DC type : 4.5 V.DC / Free-ranging type : 5.5 V.DC							
		Typical	-							
		Maximum	5.0 V.DC type : 5.5 V.DC / Free-ranging type : 27 V.DC							
Average current consumption	Without trigger input	Output OFF	Minimum	-					*2 ♣b	
			Typical	-						
			Maximum	-						
		Output ON	Minimum	-						
			Typical	I _b		5.0 V.DC type: 0.1 mA/Free-ranging type: 1.0 mA				
			Maximum	I _b		5.0 V.DC type: 0.3 mA/Free-ranging type: 1.8 mA				
	With trigger input	Output OFF	Minimum	-					*2 ♣d	
			Typical	-						
			Maximum	-						
		Output ON	Minimum	-						
			Typical	I _d		5.0 V.DC type: 0.5 mA/Free-ranging type: 1.4 mA				
			Maximum	I _d		5.0 V.DC type: 3.4 mA/Free-ranging type: 4.5 mA				
Measuring cycle (Trigger interval)	Typical	T _t	5 ms/cycle							
			Pulse width	Minimum	20 μs					Half off the distance period
				Maximum	1/2 T _t					
Level	Minimum	V _{TL}	0.8 V					*3		
	Maximum	V _{TH}	3 V							
Response performance: time from trigger pulse fall to detection output		Typical	Tr	5 ms						
Output characteristics	Remain voltage	Minimum	V _r	1.0 V.DC	1.2 V.DC	1.0 V.DC		It=10 mA		
	Leakage current	Maximum	I _l	5 μA		3 μA		V=30 V.DC		

Notes : *1. The thin short type is only available for 5.0 V.DC.

*2. The ratio between the 4 operating modes (♣a to ♣d) depends on the external trigger period and detector time, and the current consumption corresponds with this varying ratio.

*4. The output transistor is open collector.

The output transistor is turned ON by the sensor detection status and turned OFF by its non-detection status.

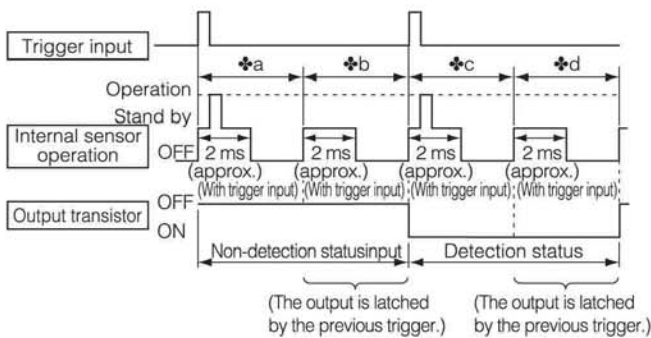

*3. A high level is established in the open state due to pull-up by the internal circuit. (Refer to the connector wiring diagram.)

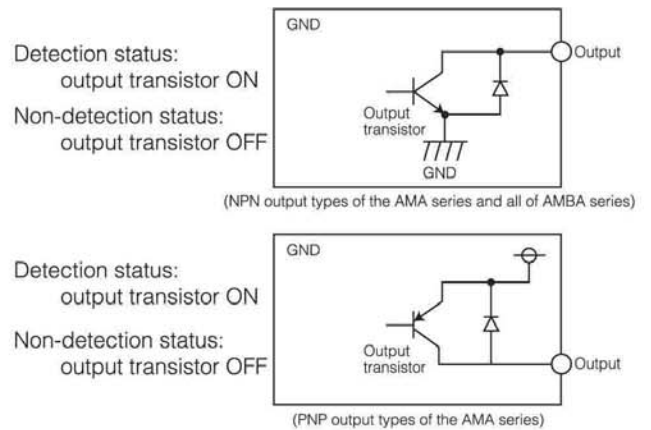

Timing chart

● Built-in oscillation circuit type

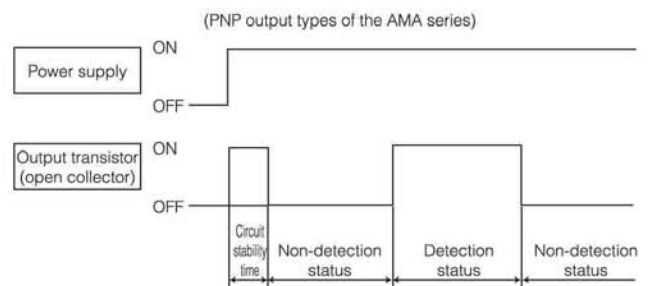
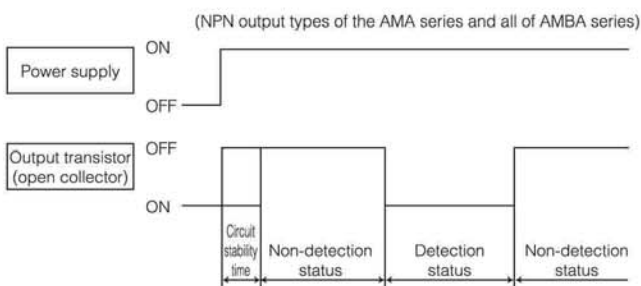

Notes : *1. Circuit stability time : Max. 12 ms

*2. During the time taken for the circuit to stabilize after the power is turned on, the ON/OFF status of the output transistor is not determined by whether the sensor is in the detection status or non-detection status.

External triggering type

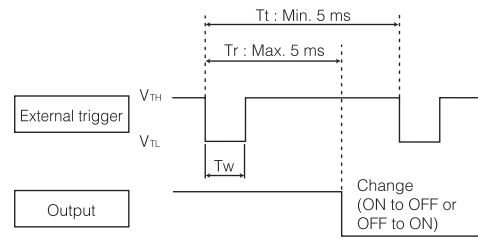
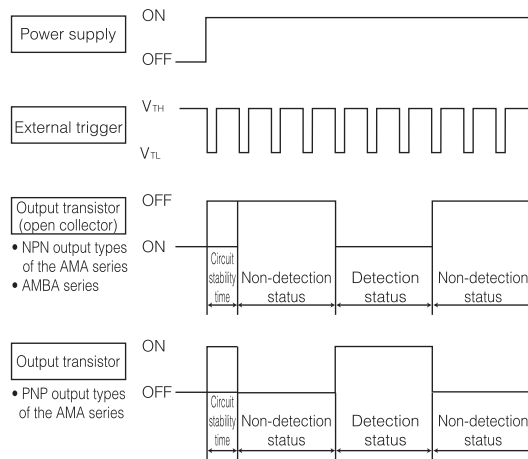

Notes : The sensor recognizes at the $V_{TH} \rightarrow V_{TL}$ edge of an external trigger that the external trigger has been input.

- Notes :
- *1. Circuit stability time: Max. 12 ms
 - *2. During the time taken for the circuit to stabilize after the power is turned on, the ON/OFF status of the output transistor is not determined by whether the sensor is in the detection status or non-detection status.

How to use

Wiring diagram of connector

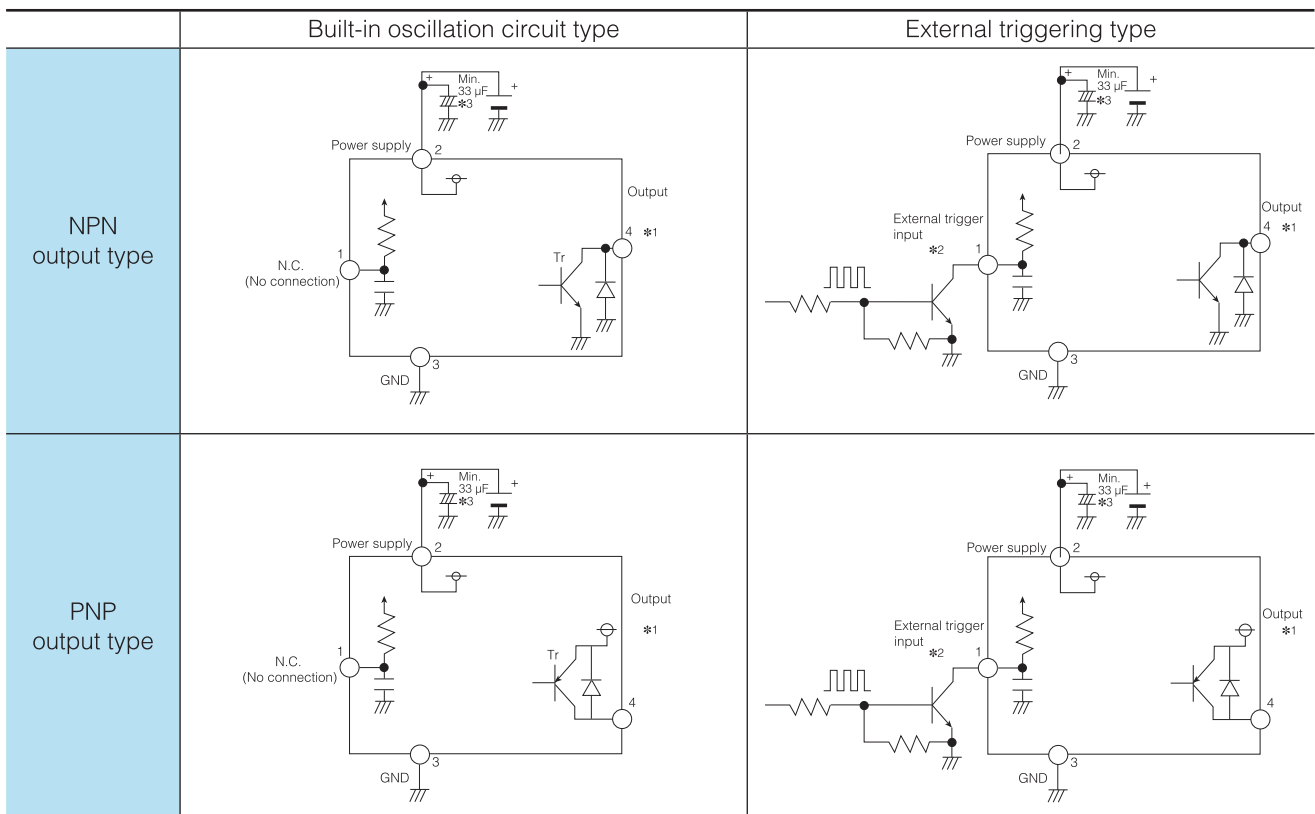

- Notes :
- *1. The output transistor has an open collector structure.
 - Detection status: Output transistor ON (connected to GND)
 - Non-detection status: Output transistor OFF (open state)
 - *2. The status of the external trigger input is as follows:
 - Open at the high level
 - GND (less than 0.8 V) at the low level
 - Do not apply a high voltage.
 - *3. Install capacitor (of 33 μ F or over) on the power input terminal of the sensor in order to secure power superimposed noise resistance and stabilize the power supply voltage.

Reference data

Operating region characteristics

How to interpret the graph

Example: Operating area of the Short Type with rated detection distance of 8 cm 3.150 inch.

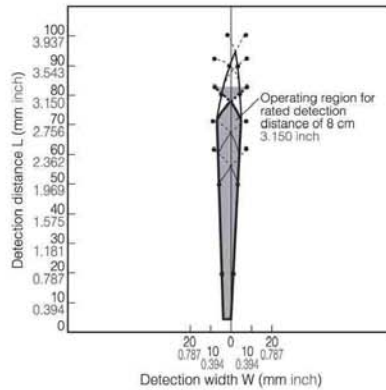

Operating area within the dotted lines

Objects that enter the entire area are detected.

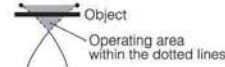

Note: If only part of the object is in the detection area, it is not detected.

Operating area within the solid lines

Objects that even partially enter the area are detected.

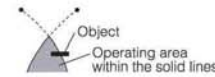

1.-(1) Thin short type (AMA1□□□□□) Short type (AMBA1□□□□□)

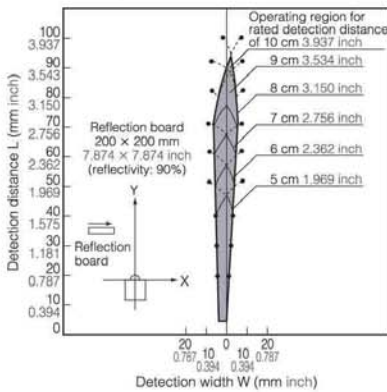

1.-(2) Middle type (AMBA2□□□□□)

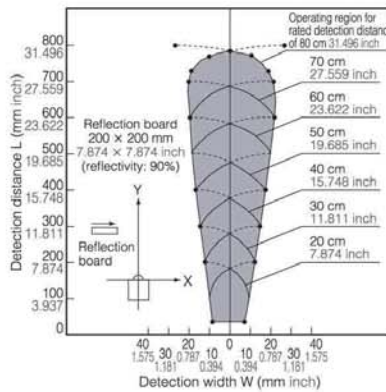

1.-(3) Long type (AMBA3□□□□□)

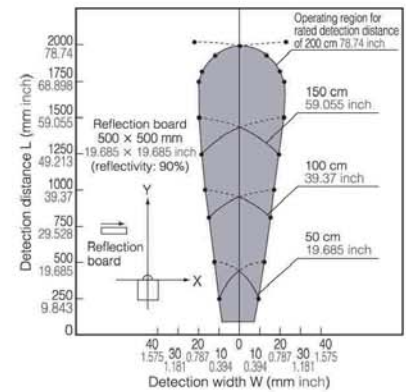

Dimensions

The CAD data of the products with a **CAD Data** mark can be downloaded from: <http://industrial.panasonic.com/>

(Common to the Built-in oscillation circuit type and External triggering type)

Thin short type (V type)

CAD Data

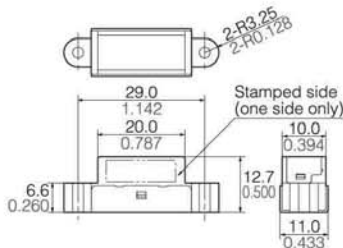

* Rear side connector protrusion: Max. 0.4mm

Short type (H type)

CAD Data

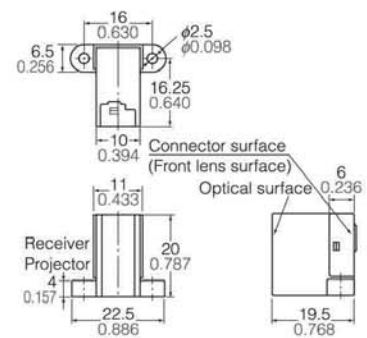

Middle type (H type)

CAD Data

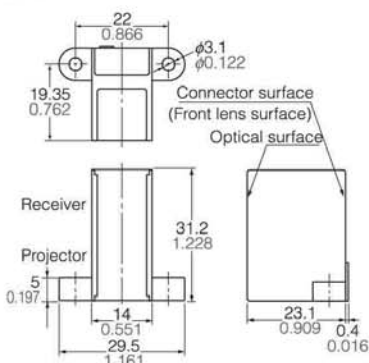

unit : mm inch

(Common to the Built-in oscillation circuit type and External triggering type)

● Long type (H type)

CAD Data

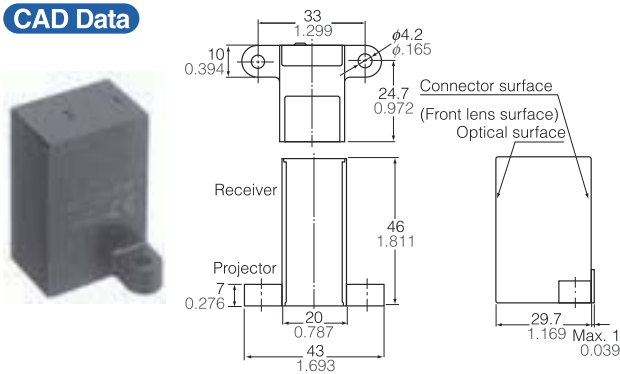

● Long type (V type)

CAD Data

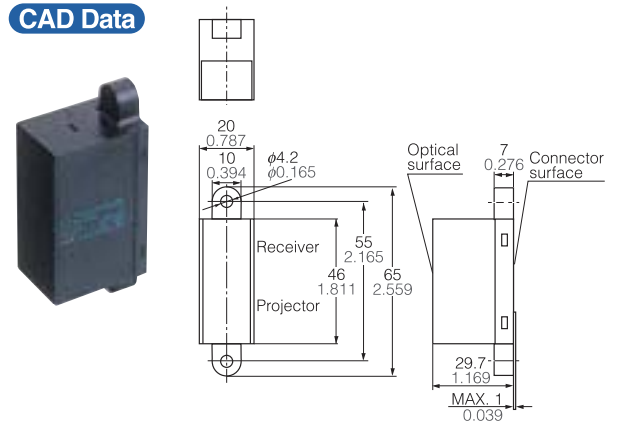

unit : mm inch

Wiring diagram (Connector surface view)

● Thin short type (V type)

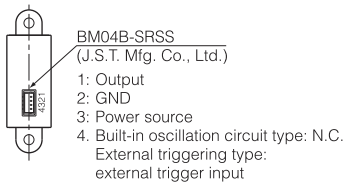

● Short type (H type)

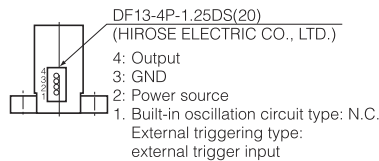

● Middle type (H type)

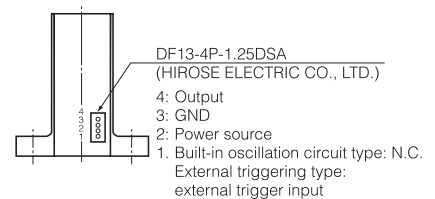

● Long type (H type)

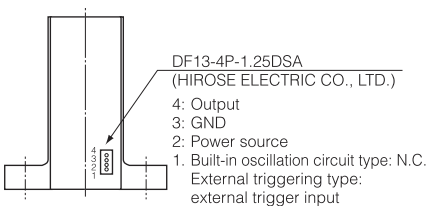

● Long type (V type)

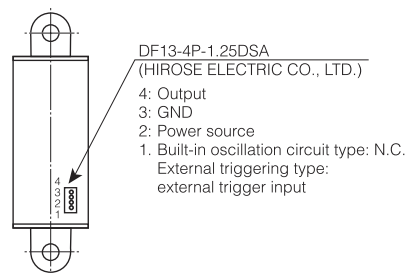

Options

● Connector with cable (for Short, Middle and Long type)
AMV9003

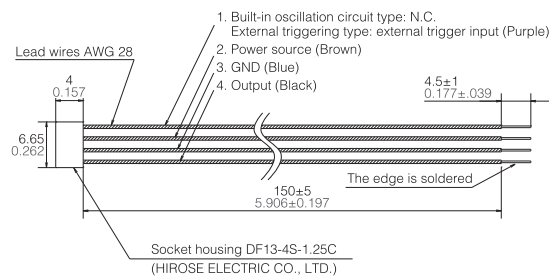

unit : mm inch

● Connector with cable (for Thin short type)
AMV9002

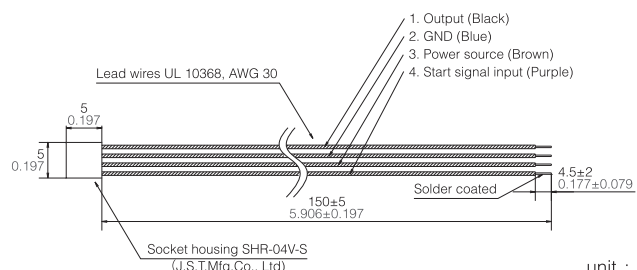

unit : mm inch

Notes

■ Use environment

- 1) Avoid use in the steamy or dusty environment, the corrosive gas, an environment where organic solvent can be adhered.
- 2) When using in a high-noise environment, perform countermeasures such as installing capacitor (of 33 μF or over) on the power input terminal of the sensor. Before use, check the performance under actual use conditions.

■ Wire connection

- 1) Before the power is supplied, recheck wiring as misconnection may damage the internal circuit. (ensure to avoid reverse connection)
- 2) Use wires shorter than 3 m 9.842 ft to protect the internal circuit. Before use, check under actual use conditions if there is no influence by surrounding environments.
- 3) Do not repeatedly attach/detach the connector.

■ Detecting part

- 1) Keep the detecting surface clean. The detecting surface is resistant to trash/ dust, however, if an excessive amount of trash/dust adhere to the surface, it may reduce the margin of detecting distance.
- 2) Dew condensation on the detecting surface may cause malfunction.
- 3) The sensor aims to detect human bodies. If the targeted object has extremely low reflectivity (e.g., objects frosted by black rubbers) or extremely high reflectivity (e.g., objects which regularly reflect: mirrors, glasses or glossy papers), the sensor may not be able to detect or the detecting distance may become unstable.
- 4) The front face of the lense and the case are polycarbonate-based. Generally they are stable against water, alcohol, oil, salt and weak acids. However, avoid alkalis, aromatic hydrocarbons and halogenated hydrocarbons as those substances may expand or melt the lense and the case.
- 5) If placing filters (covers) in front of the sensor and perform detection through the filters, following may occur: detection of the filters (covers), changes of the detecting distance or unstable operations.
- 6) If sensors are in facing positions, light from the opposing sensor may cause mutual interferences and malfunction. Before use, check the installation conditions.
- 7) When arranging multiple sensors in parallel, keep the interval of neighboring sensors as below or over. Before use, ensure that there is no mutual interference.

Part No.	Sensor interval
AMBA1 series	5 cm 1.969 inch
AMA1 series	8 cm 3.150 inch
AMBA2 series	10 cm 3.937 inch
AMBA3 series	20 cm 7.874 inch

■ Recommended mounting direction

As below, install the sensor for the X and Z advancing directions of the targeted object.

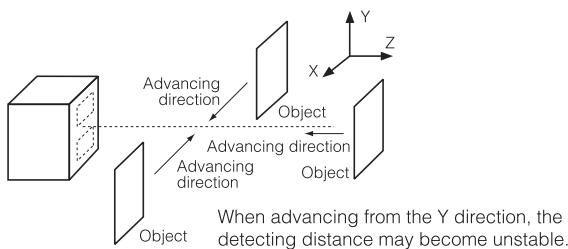

For general precautions, see "General precautions for motion sensors" in the next page.

■ Ambient operating conditions

- 1) Temperature: Refer to the absolute maximum ratings for the temperature of each individual sensor.
- 2) Humidity : 15 % to 85 % RH (No freezing nor condensation at low temperature)
- 3) Atmospheric pressure: 86 to 106 kPa
- 4) Because the humidity range differs depending on the ambient temperature, the humidity range indicated below should be used. Continuous operation of the switch is possible within this range, but continuous use near the limit of the range should be avoided. This humidity range does not guarantee permanent performance.

<MA Motion Sensor>

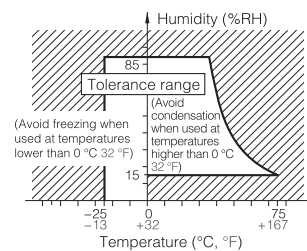

In general, degradation of electronic devices accelerates when they are operated under conditions of high temperature or high humidity. Before use, confirm the reliability of the sensors under the expected operating conditions.

- 5) The sensors do not have a water-proof or dust-proof construction. Depending on the ambient operating conditions, some means of providing protection from water and dust and preventing the formation of ice and condensation must be provided prior to using the sensors. If a sensor is used with a cover installed, the initial detection performance specifications may not be able to be met. Confirm the operation under the actual operating conditions.
- 6) Take care to avoid exposing the sensors to heat, vibration or impact since malfunctioning may result.

■ Concerning external surge voltages

Since the internal circuitry may be destroyed if an external surge voltages is supplied, provide an element which will absorb the surges.

■ Concerning power supplysuperimposed noise

- 1) Use a regulated power supply as the power supply. Otherwise, power supplysuperimposed noise may cause the sensors to malfunction.
- 2) To maintain the power supply noise performance, be certain to connect a capacitor (33 μF or more) to the sensor power supply input terminal in order to stabilize the power supply voltage.

■ Drop damage

If the sensor is dropped, damage can occur resulting in incorrect operation. If dropped, be sure to do a visual check of the exterior for noticeable damage and check the operation characteristics for faulty operation.

■ Concerning the circuit sides

Since the circuit sides given in this catalog are not protected in terms of circuit design, check out the performance and reliability of the circuits prior to using the sensors.

Safety precautions

Head the following precautions to prevent injury or accidents.

- Do not use these sensors under any circumstances in which the range of their ratings, environment conditions or other specifications are exceeded. Using the sensors in any way which causes their specifications to be exceeded may generate abnormally high levels of heat, emit smoke, etc., resulting in damage to the circuitry and possibly causing an accident.
- Before connecting a connector, check the pin layout by referring to the connector wiring diagram, specifications diagram, etc., and make sure that the connector is connected properly. Take note that mistakes made in connection may cause unforeseen problems in operation, generate abnormally high levels of heat, emit smoke, etc., resulting in damage to the circuitry.
- Do not use any motion sensor which has been disassembled or remodeled.
- Protection circuit recommended The possible failure mode is either open or short of the output transistor. An excess heat is the cause for short mode failure. For any important and serious application in terms of safety, add protection circuit or any other protection method.

Infrared Array Sensor Grid-EYE



High Precision Infrared Array Sensor based on Advanced MEMS Technology

Features

- Temperature detection of two-dimensional area: 8 × 8 (64 pixels)
- Digital output (capability of temperature value output)
- Compact SMD package (adaptively to reflow mounting)
- RoHS compliant

Typical applications

- High function home appliances (microwaves and air-conditioners)
- Energy saving at office (air-conditioning/lighting control)
- Digital signage
- Automatic doors/elevators

Ordering information

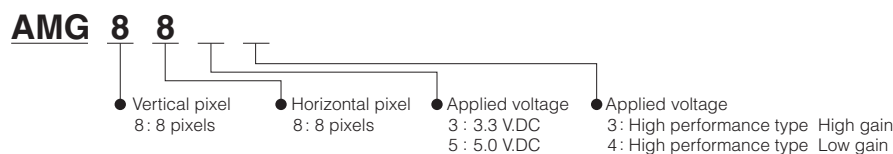

Types

Tape and reel package : 1,000 pcs.

Product name	Number of pixel	Operating voltage	Amplification factor	Part number
Infrared array sensor Grid-EYE High performance type	64 (Vertical 8 × Horizontal 8 Matrix)	3.3 V.DC	High performance type High gain	AMG8833
			High performance type Low gain	AMG8834
		5.0 V.DC	High performance type High gain	AMG8853
			High performance type Low gain	AMG8854

Rating

Item	Performance	
	High gain	Low gain
Applied voltage	3.3 V.DC±0.3 V.DC or 5.0 V.DC±0.5 V.DC	
Temperature range of measuring object	0 °C to 80 °C +32 °F to +176 °F	-20 °C to 100 °C -4 °F to +212 °F
Operating temperature range	0 °C to 80 °C +32 °F to +176 °F	-20 °C to 80 °C -4 °F to +176 °F
Storage temperature range	-20 °C to 80 °C -4 °F to +176 °F	-20 °C to 80 °C -4 °F to +176 °F

Absolute maximum ratings

Item	Absolute maximum ratings	Terminal
Applied voltage	-0.3 V.DC to 6.5 V.DC	VDD
Input voltage	-0.3 V.DC to VDD +0.3 V.DC	SCL, SDA, AD_SELECT
Output sink current	-10 mA to 10 mA	INT, SDA
Static electricity (Human body model)	1 kV	All terminals
Static electricity (Machine model)	200 V	All terminals

Characteristics

Item	Performance	
	High performance type High gain	High performance type Low gain
Temperature accuracy	Typical ± 2.5 °C ± 4.5 °F	Typical ± 3.0 °C ± 5.4 °F
Human detection distance *1	7 m or less (reference value) 22.966 ft	
NETD *2	Typ. 0.05 °C 32.900 °F 1 Hz Typ. 0.16 °C 32.288 °F 10 Hz	
Viewing angle	Typical 60 °	
Optical axis gap	Within Typical ± 5.6 °	
Current consumption	Typical 4.5 mA (normal mode) Typical 0.2 mA (sleep mode) Typical 0.8 mA (stand-by mode)	
Setup time	Typical 50 ms (Time to enable communication after setup) Typical 15 s (Time to stabilize output after setup)	

Note: *1 To have more than 4 °C 7.2 °F of temperature difference from background
 Detection object size: 700 × 250 mm 27.559 × 9.843 inch (Assumable human body size)
 *2 It is calculated from 4 pixels of centers.

Performance

Item	Performance
Number of pixel	64 (Vertical 8 × Horizontal 8 Matrix)
External interface	I ² C (fast mode)
Frame rate	Typical 10 frames/sec or 1 frame/sec
Operating mode *1	Normal Sleep Stand-by (10 sec or 60 sec intermittence)
Output mode	Temperature output
Calculate mode	No moving average or Twice moving average
Temperature output resolution	0.25 °C 32.45 °F
Number of sensor address	2 (I ² C slave address)
Thermistor output temperature range	-20 °C to 80 °C -4 °F to +176 °F
Thermistor output resolution	0.0625 °C 32.1125 °F

Note: *1 Normal Mode : normal operation mode; Sleep Mode: detection is off (output and data reading not possible); Standby Mode: 1 frame measuring intermittently every 10 or 60 sec.

Internal circuit

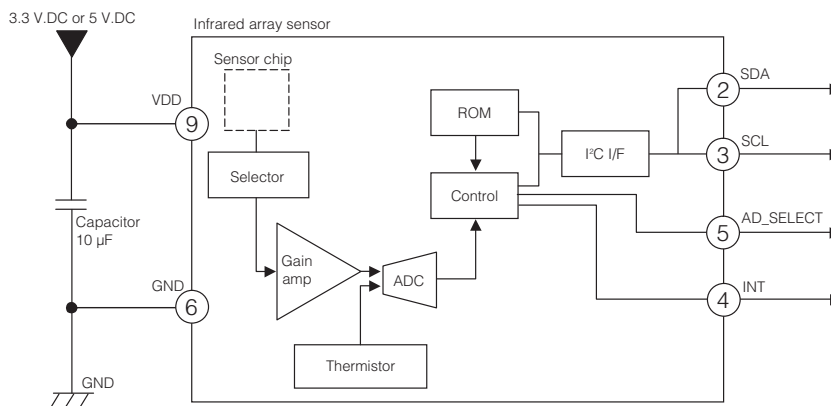

* INT terminal ④ normally has same voltage as VDD. When interrupting, same as GND (0V)

Pixel array and viewing field

(1) Pixel array
Pixel array from 1 to 64 is shown below.

(2) Viewing field
Sensor viewing field (typical) is shown below.

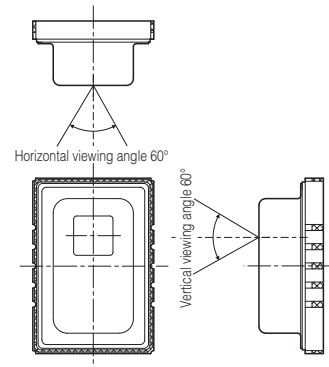
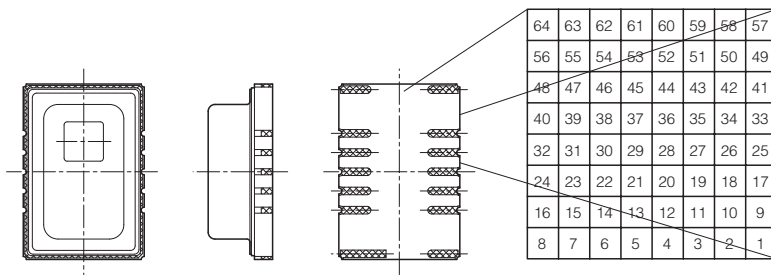

Optical properties

(1) Each pixel's viewing central angle
Sensor's optical center (the origin of graph below) gap: within $\pm 5.6^\circ$ (Typical) (Both horizontal and vertical directions)

(2) Each pixel's viewing angle (half angle)
Central 4 pixels (Pixel No. 28, 29, 36, 37) viewing angle (half angle): horizontal direction 7.7° (Typical) vertical direction 8° (Typical)

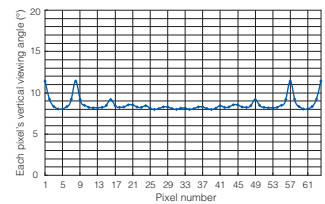
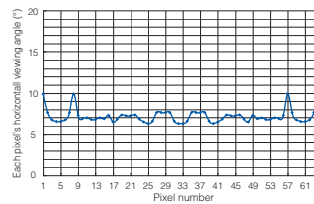
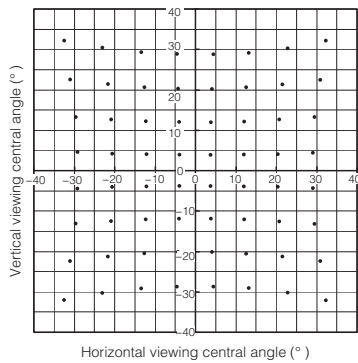

Dimensions

External dimensions

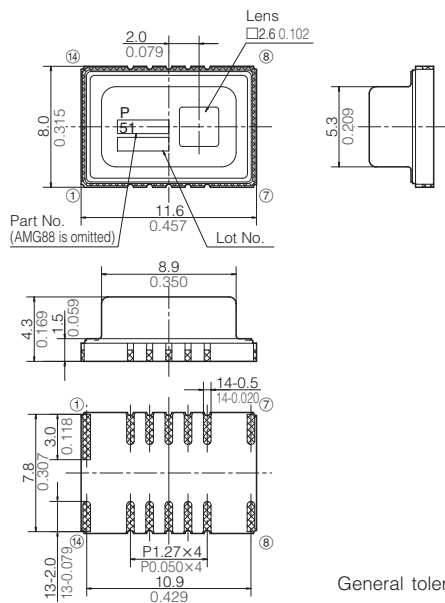

Number	Terminal Name	Number	Terminal Name
①	NC	⑧	NC
②	SDA	⑨	VDD
③	SCL	⑩	AVDD-PC
④	INT	⑪	NC
⑤	AD_SELECT	⑫	DVDD-PC
⑥	GND	⑬	VPP
⑦	NC	⑭	NC

Note : Leave terminal "NC (No. ①, ⑦, ⑧, ⑪ and ⑭)" unconnected.
Make electrical potential of terminals ⑨ and ⑬ the same.

Recommended PC board pad

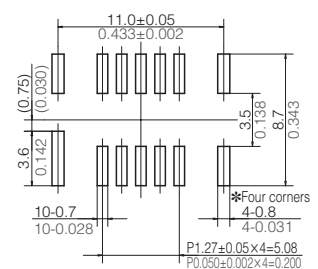

General tolerance : $\pm 0.2 \pm 0.08$

unit : mm inch

External circuit

- (1) In case of setting I²C slave address of the sensor 1101000
 * Connect terminal ⑤ (AD_SELECT) to GND.

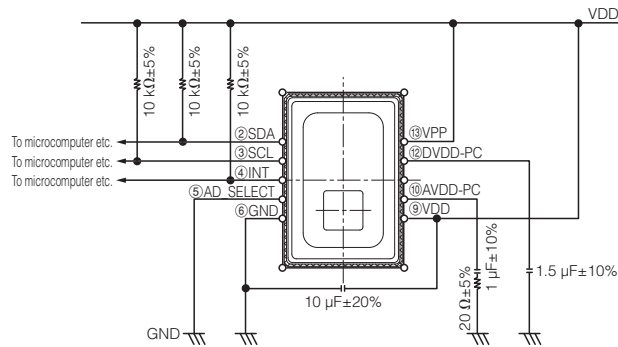

- (2) In case of setting I²C slave address of the sensor 1101001
 * Connect terminal ⑤ (AD_SELECT) to VDD.

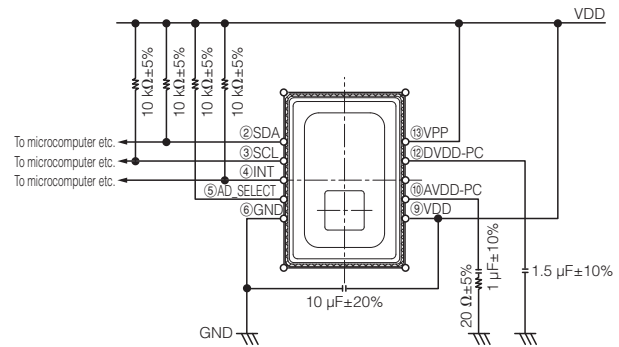

This circuit is an example to drive infrared array sensor "Grid-EYE", so that we will not take any responsibility of loss which is due to this circuit.

Packing format (Tape and reel)

Tape dimensions

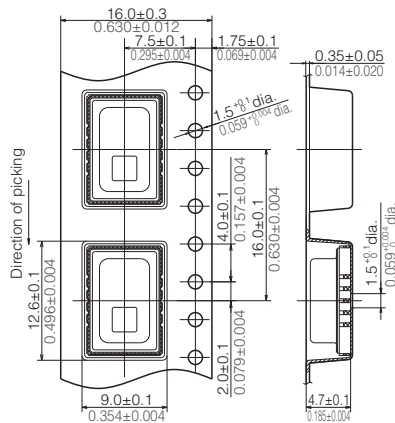

Dimensions of tape reel

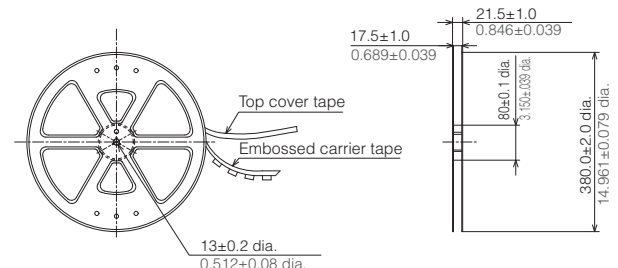

unit : mm inch

Notes

■ Precaution for fundamental structure of sensor

Infrared Array Sensor is a thermopile type infrared sensor which detects the amount of infrared rays. Below conditions generally degrade the temperature accuracy. Carefully check the performance and stability under actual use conditions, and perform temperature corrections when necessary.

- When heating elements exist near the mounting position of the sensor.
- When the sensor is exposed to cold or hot air.
- When the temperature of the sensor body rapidly changes.
- When substances (e.g., glasses, acrylics or steams), which hardly transmit a far infrared ray, exist between the sensor and the detected object.
- When substances (e.g., foreign substances or water), which hardly transmit a far infrared ray, adhere to the lense of the sensor.

■ Use environment

- 1) Temperature: See the specifications
- 2) Humidity: Between 15% and 85% R.H. (Avoid freezing and dew condensation)
- 3) Atmospheric pressure: Between 86 and 106 kPa

- 4) Vibrations and shocks may damage the sensor, and cause malfunction and performance deterioration. If loads and shocks are applied on the lense, the damaged sensor may cause malfunction and performance deterioration.
- 5) The product is not water/splash-proof. Perform water/dust-proofing and dew condensation/freezing countermeasures in accordance with use environment. When dew condensation occurs, responsiveness of heat source detection may delay for several seconds.
- 6) Avoid use and storage in the corrosive gas (organic solvent, sulfurous acid and hydrogen sulfide gases) to avoid malfunction and performance deterioration.
- 7) Use surge absorbers as applying the external surge voltage may damage the internal circuit.
- 8) Malfunction may occur near electric noises from static electricity, lightning, broadcast or amateur radio stations and mobile phones.
- 9) The sensor can continuously operate within the range of using ambient temperature (using ambient humidity). However, ensure that humidity is within the range described in the following page as humidity varies according to temperature. Avoid the continuous operation near the operational limit. The temperature range does not guarantee the durability.

Other precautions

These specifications are for individual components. Before use, carefully check the performance and quality under actual use conditions to enhance stability.

- 1) Once the individual sensor is dropped, do not use. Drop may cause functional disorders.
- 2) Writing to the unspecified register/with the unspecified bit may cause malfunction and performance deterioration. (please consult us)
- 3) Misconnection and use beyond the specified temperature range may damage the product.
- 4) Once below shocks are applied, do not use the product as applying highfrequency oscillation to the sensor body may damage the product.
 - Contact with metal objects
 - Contact with other sensors
- 5) Follow the instructions below as static electricity may damage the product.
 - For storage and transportation, avoid plastic containers which are easily electrified.
 - When storing and transporting the sensor, choose the environment where static electricity is hardly generated (e.g., humidity between 45 and 60 %) and protect the product by using electroconductive packaging materials.
 - Once unpacked, perform antistatic countermeasures.
 - (1) Operators handling sensors must wear antistatic cloths and human body grounding devices.
 - (2) Cover the surface of workbench by electro-conductive plates and ground measuring instruments and jigs.
 - (3) Use the soldering iron which has a small leakage current or ground the soldering tip.
 - (4) Ground the assembling equipment.
 - Use a stabilized power supply. A power superimposed noise may cause malfunction.

Range of using ambient temperature (using ambient humidity)

The sensor can continuously operate within the range of using ambient temperature (using ambient humidity). However, ensure that humidity is within the range below as humidity varies according to temperature. Avoid the continuous operation near the operational limit. Before use, check the stability under the usage environment as high humidity or high temperatures generally accelerates deterioration of the electronic component.

- The temperature range does not guarantee the durability

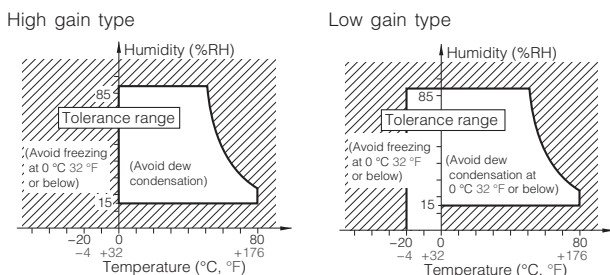

Mounting

Use the land of the printed-circuit board on which the sensor is securely fixed. The recommended printed-circuit board is FR4 (thickness 1.6 mm 0.063 inch). When mounting on the deprecated circuit board, carefully check the performance and quality under actual use conditions before use.

- A large noise on the power supply may cause malfunction. Place the recommended capacitor near the sensor (within 20 mm 0.787 inch of the wiring pattern length) between sensor input terminals (VDD-GND) to secure power superimposed noise resistance. Test with the actual machine and re-select the capacitor with optimal capacitance.
- Prevent the metal part of other electronic components from contacting with the sensor body as the upper face (where part numbers are imprinted) of the sensor is GND.

Soldering

When soldering, avoid the external thermal influence. Heat deformation may damage the sensor or deteriorate its performance. Use the non-corrosive rosin flux.

- 1) Manual soldering
 - Raise the temperature of the soldering tip between 350 and 400 °C 662 and 752 °F (30 and 60 W) and solder within 3 seconds.
 - The sensor output may vary if the load is applied on the terminal during soldering.
 - Keep the soldering tip clean.
- 2) Reflow soldering

Below are recommended temperature profiles/conditions of reflow.

 - When printing cream solder, the screen printing method is recommended.
 - For the foot pattern, see the recommended diagram of the printed-circuit board.
 - Carefully align the terminal with the pattern as self-alignment may not be reliable.
 - The temperature of the profile is the value measured near the terminal on the printed-circuit board.
 - After reflowing, when performing reflow soldering on the back surface of the circuit board, use an adhesive to fix the board.

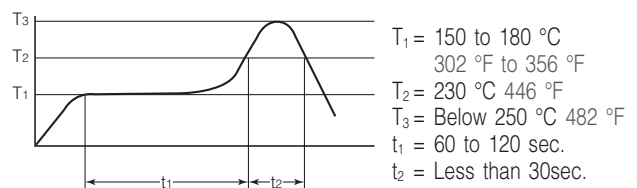

- 3) After soldering, do not apply stress on the soldered part when cutting or bending the circuit board.
- 4) Rework soldering
 - Complete rework at a time.
 - Use a flattened soldering tip when performing rework on the solder bridge. Do not add the flux.
 - Keep the soldering tip below the temperature described in the specifications.
- 5) Prevent human hands or metal pieces from contacting with the sensor terminal. Such contact may cause anomalous outlets as the terminal is exposed to the atmosphere.
- 6) After soldering, prevent chemical agents from adhering to the sensor when applying coating to avoid insulation deterioration of the circuit board.

■ Wire connection

- 1) Correctly wire as in the connection diagram. Reverse connection may damage the product and degrade the performance.
- 2) Do not use idle terminals. Such use may damage the sensor.
- 3) For cable wiring, use shield wires with possibly short wiring lengths to prevent the influence of the noise.

■ Cleaning

Avoid ultrasonic cleaning as this may cause disconnection of the wire.

■ Storage and transportation

- 1) Excessive vibrations and shocks during transport may damage the product. Carefully handle the exterior box and the reel.
- 2) Extremely bad storage conditions may deteriorate solderability or characteristics, and defect the appearance. Recommended conditions of the storage place are below.
 - Temperature: 0 to 45 °C 32 to 113 °F
 - Humidity: Below 70 % R.H.
 - Atmosphere: Low-dust and free from noxious chemicals such as sulfurous acid gas
- 3) The package is moisture-proof due to its sensitivity to humidity. When storing the sensor, follow the instructions below.
 - Promptly use after opening. (within a week, below 30 °C 86 °F/60 % R.H.)
 - Once unpacked, preserving in a moisture-proof manner, such as keeping in a moisture-proof bag with silica gels, is recommended for long-term storage. (use within 3 months)

* During soldering, when adding thermal stress in a moisture absorbing state, moisture evaporates, swells and generates stress to the internal package. To avoid swellings and cracks in the surface of the package, follow the soldering conditions.

■ Special notes

We exert maximum efforts for quality control of the product, however :

- 1) To prevent occurrence of unexpected circumstances, please inform us of the specifications of your product, customers, use conditions and details of the attachment position.
- 2) Have sufficient margin values of driving/performance guarantee described in the specifications and apply safety measures with double circuits, if serious effects on human lives or property are predicted due to a quality failure of the product. Those countermeasures are also for the product liability.

- 3) A warranty period is one year after the delivery to your company. Quality assurance is limited to the items and the scopes described in the specifications.

If a defect is found after the delivery, we will promptly provide a replacement or change/repair the defect part at the place of delivery in good faith. Exceptions are below.

- Damages by a failure or a defect which arose after the delivery.
- After the delivery, when storing and transporting, if conditions other than conditions in the specifications are applied to the product.
- Damages by unforeseen phenomenon which cannot be predicted with the technologies available at the time of delivery.
- Damages by natural and anthropogenic disasters, such as earthquake, flood, fire and war, which are beyond our reasonable control.

Pressure Sensor PS-A



Pressure sensor
Built-in amplifier and compensating circuit

Features

- Built-in amplifier and temperature compensation circuit, no need for circuit design and characteristic adjustment
- High accuracy and reliability : overall accuracy $\pm 1.25\%$ FS (Standard), $\pm 2.5\%$ FS (Low-pressure type)
- Compact size, space-saving : compatible size for PS type (Standard/Economy, S and M packages)
- RoHS compliant

Typical Applications

- Industrial use : pressure switches and pneumatic components, compressed air pressure measuring devices
- Medical use : blood pressure meters, oxygen generator and airbeds
- Others : pressure sensing devices for air pressure mediums

Low-pressure type

- Water level detection for domestic appliances: washing machines and dishwashers
- Air pressure control : cleanrooms and smoking rooms
- Medical applications : breathing pressure measuring devices

Ordering Information

ADP5

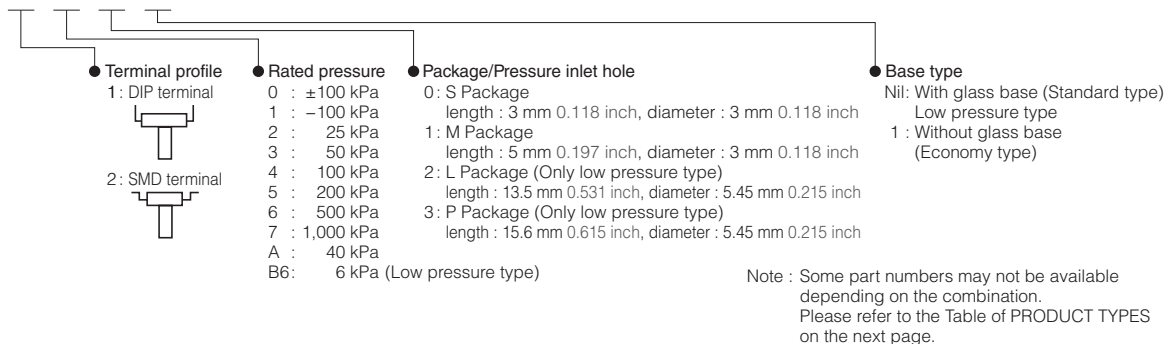

Product Types

Package (Pressure inlet hole length)	Part No.								
	Standard type		Standard/Economy type		Low pressure type				
	S Package (3 mm 0.118 inch)		M Package (5 mm 0.118 inch)		M Package (5 mm 0.197 inch)	L Package (13.5 mm 0.531 inch)	P Package (15.6 mm 0.614 inch)		
Terminal	DIP terminal	SMD terminal	DIP terminal	SMD terminal	DIP terminal	DIP terminal	DIP terminal	DIP terminal	DIP terminal
Standard type (with glass base)	± 100 kPa	ADP5100	ADP5200	ADP5101	ADP5201	—	—	—	—
	-100 kPa	ADP5110	ADP5210	ADP5111	ADP5211	—	—	—	—
	25 kPa	ADP5120	—	ADP5121	—	—	—	—	—
	50 kPa	ADP5130	—	ADP5131	—	—	—	—	—
	100 kPa	ADP5140	ADP5240	ADP5141	ADP5241	—	—	—	—
	200 kPa	ADP5150	ADP5250	ADP5151	ADP5251	—	—	—	—
	500 kPa	ADP5160	ADP5260	ADP5161	ADP5261	—	—	—	—
1,000 kPa	ADP5170	ADP5270	ADP5171	ADP5271	—	—	—	—	
Economy type (without glass base)	40 kPa	—	—	ADP51A11	—	—	—	—	—
Low pressure type	6 kPa	—	—	—	—	ADP51B61	ADP51B62	ADP51B63	—

Standard packing : Carton : 100 pcs.; Case : 1,000 pcs.

Rating

● Standard type

Item	Standard type (with glass base)								Remarks
Type of pressure	Gauge pressure								
Pressure medium	Air								*1
Rated pressure (kPa)	±100	-100	25	50	100	200	500	1,000	
Max. applied pressure	Twice of the rated pressure								1.5 times the rated pressure
Ambient temperature	-10 °C to +60 °C 14 °F to +140 °F (no freezing or condensation)								
Storage temperature	-20 °C to +85 °C -4 °F to +185 °F (no freezing or condensation)								
Drive voltage	5±0.25 V.DC								
Temperature compensation range	0 °C to 50 °C 32 °F to 122 °F								
Offset voltage	2.5±0.05	0.5±0.05 V							*2, 3, 5
Rated output voltage	4.5±0.05 (+when +100kPa)	4.5±0.05 V							*2, 3, 5
Overall accuracy	±1.25 %FS								*3, 4, 5
Current consumption	Max. 10 mA								*2, 3
Output impedance	15 Ω (Typical)								*2
Source current	Max. 0.2 mA								*2, 3
Sink current	Max. 2 mA								*2, 3

Notes : *1 Please consult us for pressure media other than air.

*2 Indicates output when temperature is 25 °C 77 °F.

*3 Indicates output when drive voltage is 5 V. Although output fluctuates due to fluctuations in the drive voltage, this is not included.

*4 Overall accuracy indicates the accuracy of the offset voltage and rated output voltage at a temperature compensation range of 0 to 50 °C 32 to 122 °F.

*5 Accuracy is the value at the time of our shipping. Please set Zero-point calibration function on your products in order to safely use if the offset voltage is shifted.

● Economy type

Item	Economy type (without glass base)								Remarks
Type of pressure	Gauge pressure								
Pressure medium	Air								*1
Rated pressure (kPa)	40								
Max. applied pressure	Twice of the rated pressure								
Ambient temperature	-5 °C to +50 °C 23 °F to +122 °F (no freezing or condensation)								
Storage temperature	-20 °C to +70 °C -4 °F to +158 °F (no freezing or condensation)								
Drive voltage	3±0.15 V.DC								
Temperature compensation range	5 °C to 45 °C 41 °F to 113 °F								
Offset voltage	0.3±0.09 V								*2, 3, 5
Span voltage	2.4±0.03 V								*2, 3, 5
Offset voltage temperature characteristics	±4.0 %FS								*3, 4, 5
Sensitivity temperature characteristics	1.3 %FS								*3, 4, 5
Current consumption	Max. 3 mA								*2
Output impedance	20 Ω (Typical)								*2, 3
Source current	Max. 0.15 mA								*2, 3
Sink current	Max. 1.5 mA								*2, 3

Notes : *1 Please consult us for pressure media other than air.

*2 Indicates output when temperature is 25 °C 77 °F.

*3 Indicates output when drive voltage is 3 V. Although output fluctuates due to fluctuations in the drive voltage, this is not included.

*4 Indicates from output value at 25 °C 77 °F and the change of output at 5 and 45 °C 41 to 113 °F.

*5 Accuracy is the value at the time of our shipping. Please set Zero-point calibration function on your products in order to safely use if the offset voltage is shifted.

● Low pressure type

Item	Economy type (without glass base)	Remarks
Type of pressure	Gauge pressure	
Pressure medium	Air	*1
Rated pressure (kPa)	6	
Max. applied pressure	Twice of the rated pressure	
Ambient temperature	0 °C to +70 °C 32 °F to +158 °F (no freezing or condensation)	
Storage temperature	-30 °C to +100 °C -22 °F to +212 °F (no freezing or condensation)	
Drive voltage	5±0.25 V.DC	
Temperature compensation range	0 °C to 70 °C 32 °F to 158 °F	
Offset voltage	0.5 V (Typical)	*2
Span voltage	4.0 V (Typical)	*2
Overall accuracy	±2.5 %FS	*2, 3, 4
Current consumption	Max. 10 mA	
Output impedance	50 Ω (Typical)	
Source current	Max. 0.2 mA	
Sink current	Max. 2.0 mA	

Notes : *1 Please consult us for pressure media other than air.

*2 Indicates output when drive voltage is 5 V. Although output fluctuates due to fluctuations in the drive voltage, this is not included.

*3 Overall accuracy indicates the accuracy of the offset voltage and span voltage at temperatures between 0 to 70 °C 32 to 158 °F (FS=4V)

*4 The initial offset voltage error is not included in the overall accuracy.

Reference Data

● Standard type

1.-(1) Output voltage

ADP5170
Drive voltage : 5 V.DC
Temperature : 25 °C 77 °F
Applied pressure : 0 to +1,000 kPa

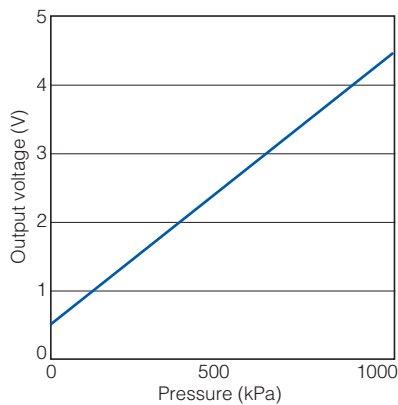

1.-(2) Overall accuracy (Offset voltage)

ADP5170
Drive voltage : 5 V.DC
Temperature : 0 to 50 °C 32 to 122 °F
Applied pressure : 0 kPa

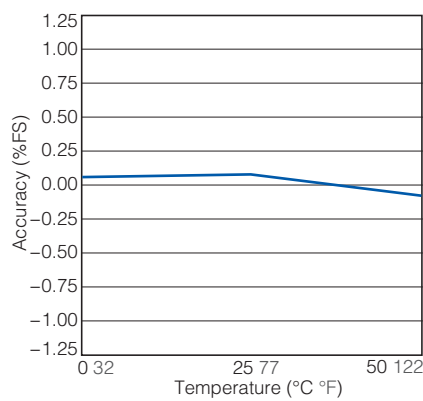

1.-(3) Overall accuracy (Rated output voltage)

ADP5170
Drive voltage : 5 V.DC
Temperature : 0 to 50 °C 32 to 122 °F
Applied pressure : +1,000 kPa

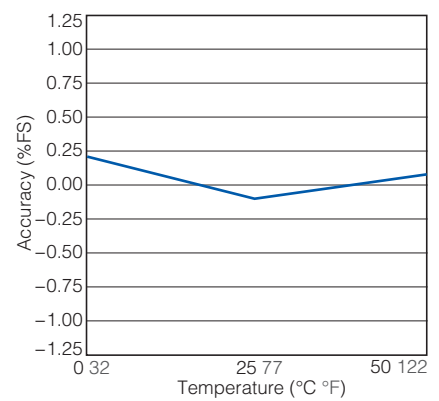

2.-(1) Output voltage

ADP5100
Drive voltage : 5 V.DC
Temperature : 25 °C 77 °F
Applied pressure : -100 to +100 kPa

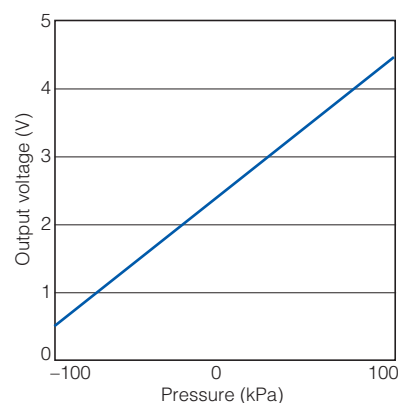

2.-(2) Overall accuracy (Offset voltage)

ADP5100
Drive voltage : 5 V.DC
Temperature : 0 to 50 °C 32 to 122 °F
Applied pressure : 0 kPa

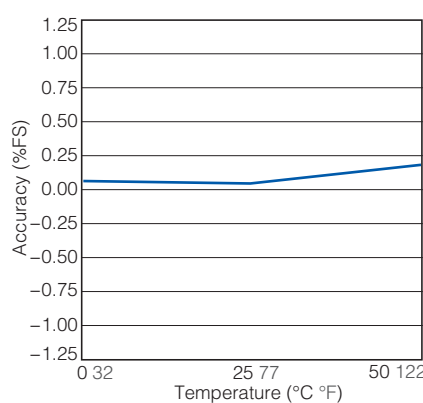

2.-(3) Overall accuracy (Rated output voltage)

ADP5100
Drive voltage : 5 V.DC
Temperature : 0 to 50 °C 32 to 122 °F
Applied pressure : +100 kPa

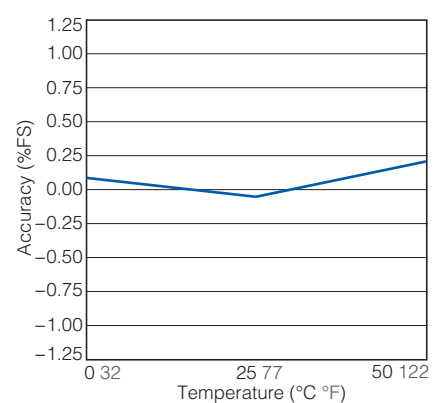

● Low pressure type

1 Output voltage

ADP51B61
 Drive voltage : 5 V.DC
 Temperature : 25 °C 77 °F
 Applied pressure : 0 to 6 kPa

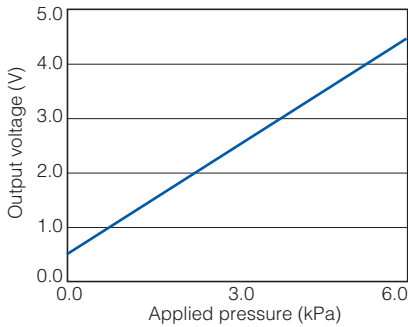

2 THB (high temperature high humidity bias test)

ADP51B61
 Within 85 °C 185 °F and 85% RH
 5 V applied between No.2 (Vdd) and No.3 (GND)
 Applied pressure : 0 kPa

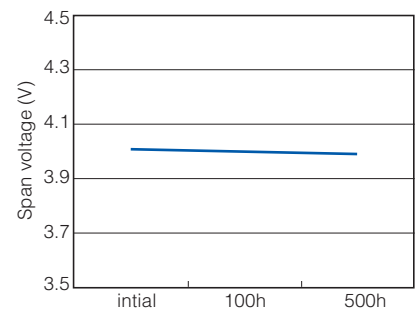
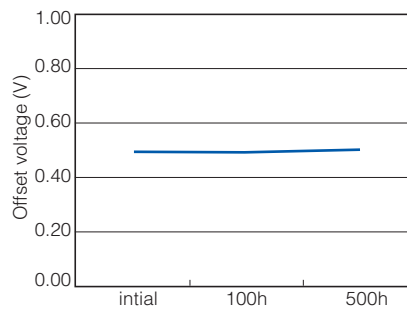

3 Ambient temperature characteristics

Ambient temperature : 25 °C 77 °F → 0 °C 32 °F → 10 °C 50 °F → 60 °C 140 °F → 70 °C 158 °F

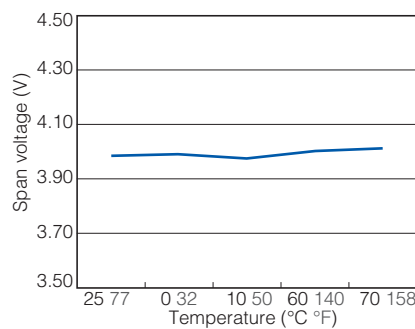
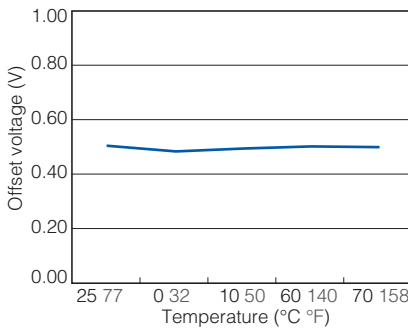

4 Shock test

ADP51B61
 Shock applied : 981 m/s², 3 times in x, y and z directions
 Applied pressure : 0 kPa

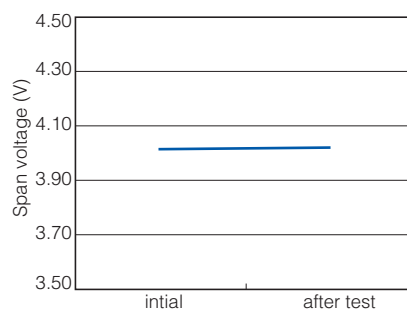
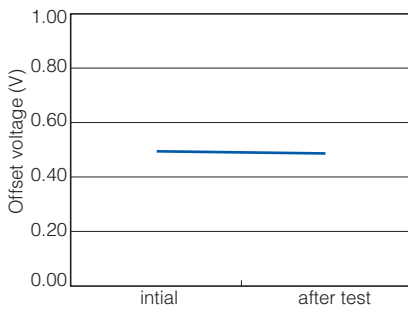

5 Vibration test

ADP51B61
 Vibration applied : 10 to 55 Hz, amplitude : 1.5mm, x, y and z directions, 2 hrs each
 Applied pressure : 0 kPa

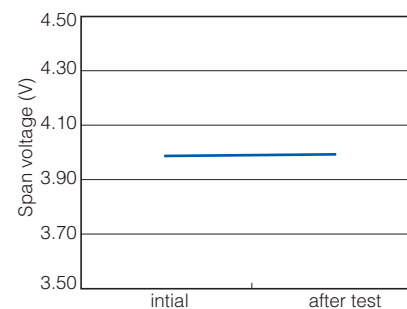
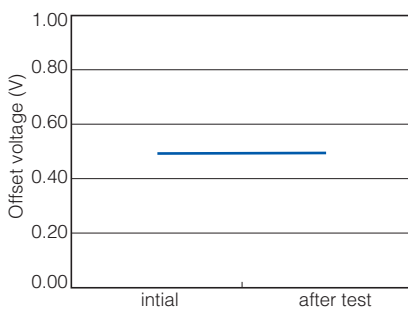

6 Temperature/humidity cycle test
 ADP51B61
 Exposed to 10 cycles in the temperature and humidity conditions given below.
 Applied pressure : 0kPa

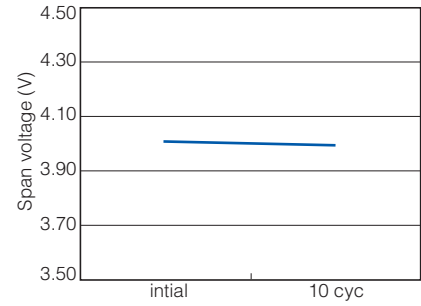
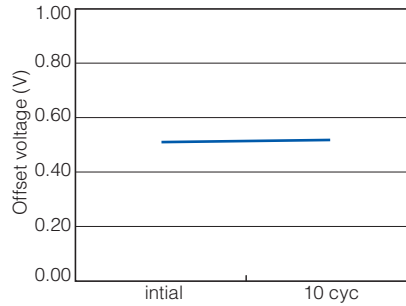
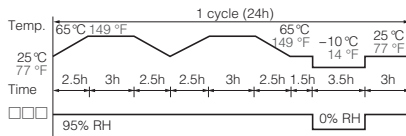

Evaluation Test

Classification	Tested item	Tested condition	Result
Environmental characteristics	Storage at high temperature	Temperature : Left in a 85 °C 185 °F constant temperature bath; Time : 100 hrs.	Passed
	Storage at low temperature	Temperature : Left in a -20 °C -4 °F constant temperature bath; Time : 100 hrs.	Passed
	Humidity resistance	Temperature/humidity : Left at 40 °C 104 °F, 90 % RH; Time : 100 hrs.	Passed
	Temperature cycle	Temperature : -20 °C to 85 °C -4 °F to 185 °F; 1 cycle : 30 min.; Times of cycle : 100	Passed
Endurance characteristics	High temperature/high humidity operation	Temperature/humidity : 40 °C 104 °F, 90% RH; Operation times : 10 ⁶ , rated voltage applied	Passed
Mechanical characteristics	Vibration resistance	Double amplitude : 1.5 mm 0.059 inch; Vibration : 10 to 55 Hz; Applied vibration direction : X, Y, Z 3 directions; Times : 2 hrs each	Passed
	Dropping resistance	Dropping height : 75 cm 29.528 inch; Times : 2 times	Passed
	Terminal strength	Pulling strength : 9.8 N {1 kgf}, 10 sec.; Bending strength : 4.9 N {0.5 kgf}, left and right 90 ° 1 time	Passed
Soldering Characteristics	Solderability	Temperature : 230 °C 446 °F; Time : 5 sec.	Passed
	Heat resistance (DIP)	Temperature : 260 °C 500 °F; Time : 10 sec.	Passed

Items	Criteria
Offset voltage Rated Output Voltage	Variation amount within $\pm 2.5\%$ FS of value

Dimensions

The CAD data of the products with a **CAD Data** mark can be downloaded from: <http://industrial.panasonic.com/>

- Standard type S Package (Terminal direction : DIP terminal Pressure inlet hole length : 3 mm 0.118 inch)
ADP51□□

CAD Data

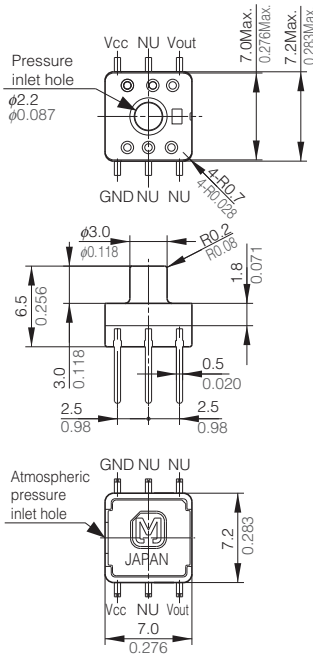

Recommended PC board pattern

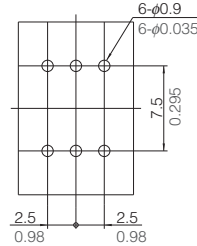

Terminal connection diagram

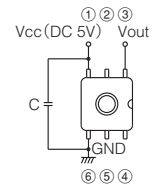

unit : mm inch

General tolerance : ±0.3 ±0.012

Terminal No.	Name
1	Vcc (Power supply [+])
2	NU (Not usable)
3	Vout (Output)
4	NU (Not usable)
5	NU (Not usable)
6	GND (Ground)

- Standard type S Package (Terminal direction : SMD terminal Pressure inlet hole length : 3 mm 0.118 inch)
ADP52□□

CAD Data

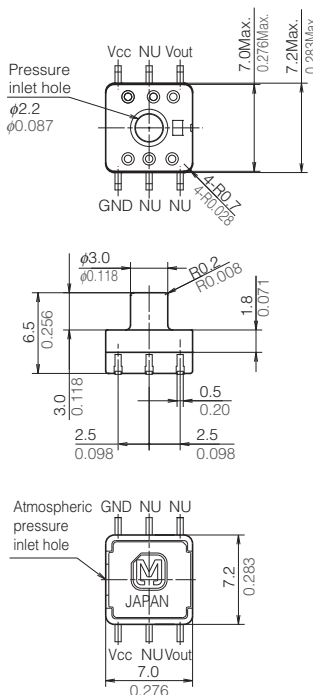

Recommended PC board pattern

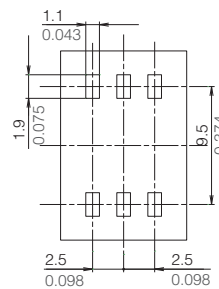

Terminal connection diagram

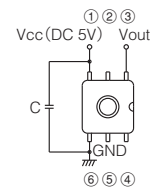

unit : mm inch

General tolerance : ±0.3 ±0.012

Terminal No.	Name
1	Vcc (Power supply [+])
2	NU (Not usable)
3	Vout (Output)
4	NU (Not usable)
5	NU (Not usable)
6	GND (Ground)

Dimensions

The CAD data of the products with a **CAD Data** mark can be downloaded from: <http://industrial.panasonic.com/>

- Standard/Economy type M Package (Terminal direction : DIP terminal Pressure inlet hole length : 5 mm 0.197 inch)
ADP51□1/ADP51A11

CAD Data

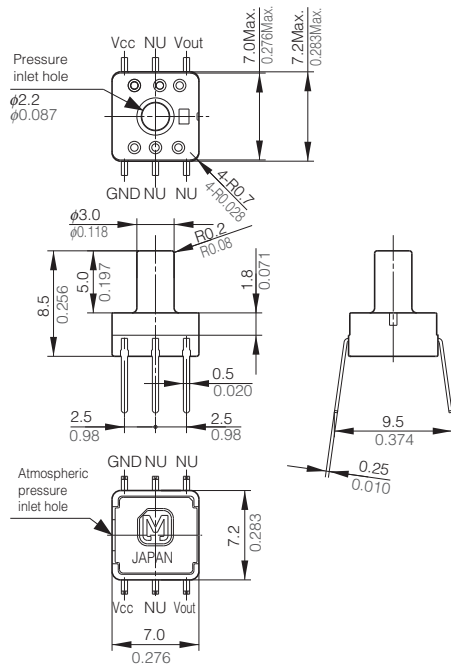

Recommended PC board pattern

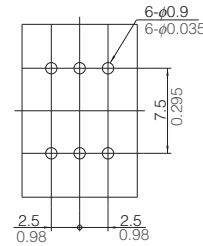

Terminal connection diagram

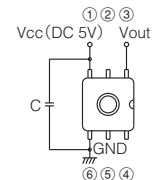

unit : mm inch
General tolerance : ±0.3 ±0.012

Terminal No.	Name
1	Vcc (Power supply [+])
2	NU (Not usable)
3	Vout (Output)
4	NU (Not usable)
5	NU (Not usable)
6	GND (Ground)

- Standard type M Package (Terminal direction : SMD terminal Pressure inlet hole length : 5 mm 0.197 inch)
ADP52□1

CAD Data

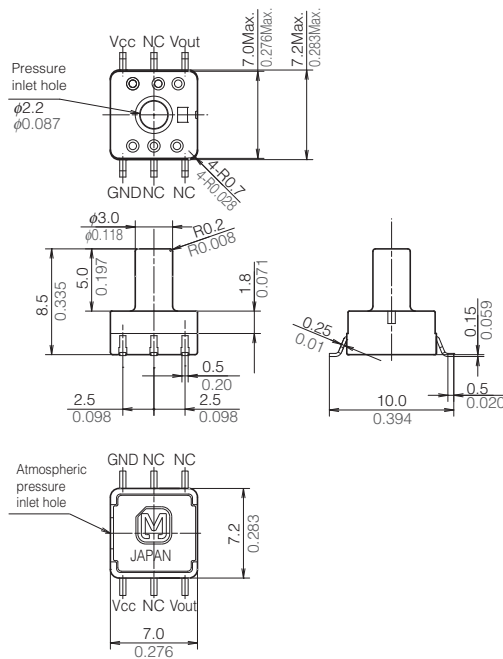

Recommended PC board pattern

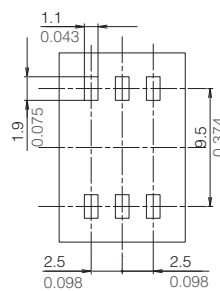

Terminal connection diagram

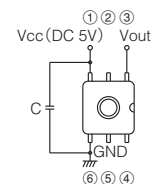

unit : mm inch
General tolerance : ±0.3 ±0.012

Terminal No.	Name
1	Vcc (Power supply [+])
2	NU (Not usable)
3	Vout (Output)
4	NU (Not usable)
5	NU (Not usable)
6	GND (Ground)

Dimensions

The CAD data of the products with a **CAD Data** mark can be downloaded from: <http://industrial.panasonic.com/>

- Low pressure type M Package (Terminal direction : DIP terminal, Pressure inlet hole length : 5 mm 0.197 inch) ADP51B61

CAD Data

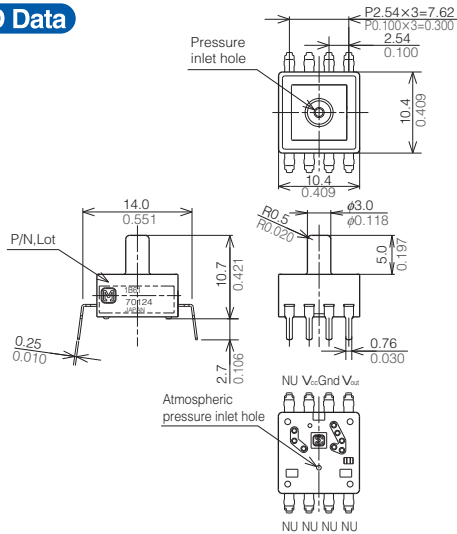

Recommended PC board pattern (BOTTOM VIEW)

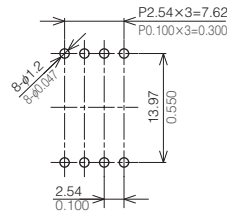

Terminal connection diagram

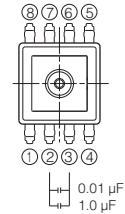

unit : mm inch
General tolerance : ±0.3 ±0.012

Terminal No.	Name	Terminal No.	Name
1	NU (Not usable)	5	NU (Not usable)
2	Vcc (Power supply [+])	6	NU (Not usable)
3	GND (Ground)	7	NU (Not usable)
4	Vout (Output)	8	NU (Not usable)

- Low pressure type L Package (Terminal direction : DIP terminal, Pressure inlet hole length : 13.5 mm 0.531 inch) ADP51B62

CAD Data

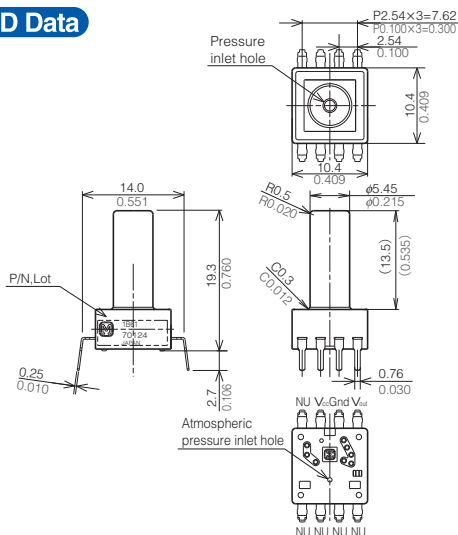

Recommended PC board pattern (BOTTOM VIEW)

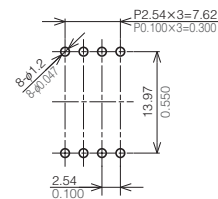

Terminal connection diagram

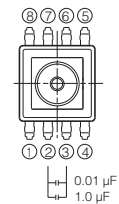

unit : mm inch
General tolerance : ±0.3 ±0.012

Terminal No.	Name	Terminal No.	Name
1	NU (Not usable)	5	NU (Not usable)
2	Vcc (Power supply [+])	6	NU (Not usable)
3	GND (Ground)	7	NU (Not usable)
4	Vout (Output)	8	NU (Not usable)

- Low pressure type P Package (Terminal direction : DIP terminal, Pressure inlet hole length : 15.6 mm 0.614 inch) ADP51B63

CAD Data

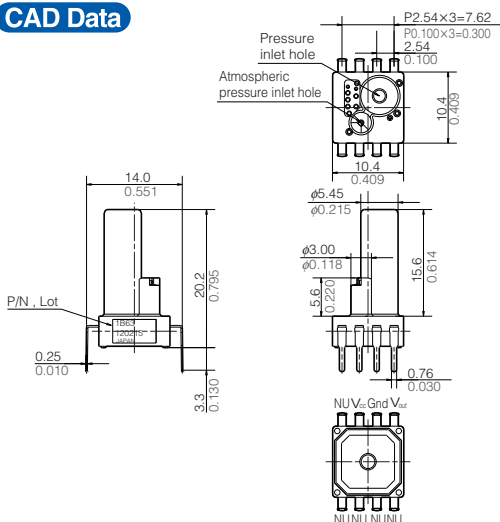

Recommended PC board pattern (BOTTOM VIEW)

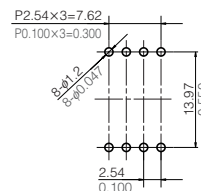

Terminal connection diagram

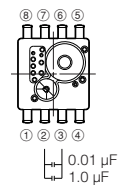

unit : mm inch
General tolerance : ±0.3 ±0.012

Terminal No.	Name	Terminal No.	Name
1	NU (Not usable)	5	NU (Not usable)
2	Vcc (Power supply [+])	6	NU (Not usable)
3	GND (Ground)	7	NU (Not usable)
4	Vout (Output)	8	NU (Not usable)

NOTES

■ Mounting

Use the land of the printed-circuit board on which the sensor is securely fixed.

■ Soldering

Avoid the external thermal influence as the product has a limited thermal capacity due to its compact structure. Heat deformation may damage the sensor or deteriorate its performance. Use the non-corrosive rosin flux. Prevent the flux from entering into the inside of the product as the sensor is exposed to the atmosphere.

- 1) Manual soldering
 - Raise the temperature of the soldering tip between 260 and 300 °C 500 and 572 °F (30 W) and solder within 5 seconds.
 - The sensor output may vary if the load is applied on the terminal during soldering.
 - Keep the soldering tip clean.
- 2) DIP soldering (DIP Terminal)
 - Keep the temperature of the DIP solder tank below 260 °C 572 °F and solder within 5 seconds.
 - To avoid heat deformation, do not perform DIP soldering when mounting on the circuit board which has a small thermal capacity.
- 3) Reflow soldering (SMD Terminal)
 - The recommended reflow temperature profile conditions are given below.

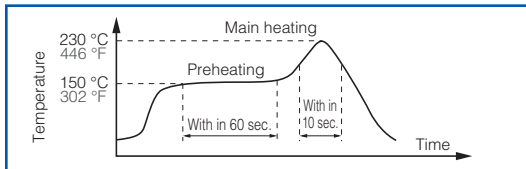

- We recommend the screen solder printing method as the method of cream.
 - Please refer to the recommended PC board specification diagram for the PC board foot pattern.
 - Self alignment may not always work as expected, therefore, please carefully the position of the terminals and pattern.
 - The temperature of the profile is assumed to be a value measured with the printed wiring board of the terminal neighborhood.
 - Please evaluate solderability under the actual mounting conditions since welding and deformation of the pressure inlet port may occur due to heat stress depending on equipments or conditions.
- 4) Rework soldering
 - Complete rework at a time.
 - Use a flattened soldering tip when performing rework on the solder bridge. Do not add the flux.
 - Keep the soldering tip below the temperature described in the specifications.
 - 5) Avoid drop and rough handling as excessive force may deform the terminal and damage soldering characteristics.
 - 6) Keep the circuit board warpage within 0.05 mm of the full width of the sensor.
 - 7) After soldering, do not apply stress on the soldered part when cutting or bending the circuit board.
 - 8) Prevent human hands or metal pieces from contacting with the sensor terminal. Such contact may cause anomalous outlets as the terminal is exposed to the atmosphere.
 - 9) After soldering, prevent chemical agents from adhering to the sensor when applying coating to avoid insulation deterioration of the circuit board.
 - 10) Please consult us concerning leadfree soldering.

■ Wire connection

- 1) Correctly wire as in the connection diagram. Reverse connection may damage the product and degrade the performance.
- 2) Do not use idle terminals to prevent damages to the sensor.

■ Cleaning

- Prevent cleaning liquid from entering the inside of the product as the sensor is exposed to the atmosphere.
- Do not perform ultrasonic cleaning in order to prevent damages to the product.

■ Environment

- 1) Avoid use and storage in the corrosive gas (organic solvent, sulfurous acid and hydrogen sulfide gases) which negatively affects the product.
- 2) Install the capacitor on the power supply terminal of the sensor and stabilize supply voltage to maintain a superimposed noise resistance. Recommended installation is to arrange 0.1 μF and 1,000 pF in parallel. Before use, check the noise resistance and select/add the optimal capacitor.
- 3) Use surge absorbers as applying the external surge voltage may damage the internal circuit.
- 4) Malfunction may occur near electric noises from static electricity, lightning, broadcast or amateur radio stations and mobile phones.
- 5) Avoid use in a place where these products come in contact with water as the sensor does not have a splash-proof construction.
- 6) Avoid use in an environment where these products cause dew condensation. When water attached to the sensor chip freezes, the sensor output may be fluctuated or damaged.
- 7) Due to the structure of the pressure sensor chip, the output varies under light. Do not expose the sensor chip to light when applying a voltage by using a transparent tube.
- 8) Do not apply high-frequency oscillation, such as ultrasonic waves, to the product.

■ Quality check under actual use conditions

These specifications are for individual components. Before use, carefully check the performance and quality under actual use conditions to enhance stability.

■ Other precautions

- 1) The wrong mounting method and the pressure range may invite the risk of accidents.
- 2) Only applicable pressure medium is dry air. Avoid use in the corrosive gas (organic solvent, sulfurous acid and hydrogen sulfide gases) or other mediums containing moisture or foreign substances. Such mediums may damage or break the product.
- 3) The pressure sensor chip is located inside the pressure introduction port. Do not insert foreign substances, such as wires, into the port as those substances may damage the chip and close the port. Do not block the atmosphere introduction port.
- 4) Use electric power within the rated power range. Use beyond the range may damage the product.
- 5) Follow below instructions as static electricity may damage the product:
 - (1) For Storage, short the circuit between terminals by using conductive substances or wrap the whole chip with aluminum foil. For storage and transportation, avoid plastic containers which are easily electrified.
 - (2) Before use, connect electrified materials on desk and operators to the ground in order to safely discharge static electricity.
- 6) Carefully select and fix tubes, introduction pipes and products based on the working voltage. Please contact us for any inquires.
- 7) After mounding the pressure sensor, prevent the potting agent from entering the pressure and the atmosphere introduction ports when coating the circuit board. Use the elastic resin as the heated resin may expand, contract and apply pressure to the sensor. After coating, carefully check if the sensor can be used.

Safety precautions

Accidents occur at certain probability for Electronic components and equipment in spite that we keep working on a improvement in quality and reliability. In order that accidents result in injury or death, fire accidents and social damages do not occur, please pay enough attention to safety design such as redundancy design, fire spread preventing design and malfunction preventing design etc.

Our quality standards fall into the following three categories depending on the applications of the products:

Reference Standards, Special Standards, and Specified Standards that meet the quality assurance program designated by the customer. These quality standards have been established so that our products will be used for the applications listed below.

Reference Standards: Computers, office automation equipment, communications equipment, audio-video products, home electrical appliances, machine tools, personal devices, industrial robots

Special Standards: Transportation equipment (automobiles, trains, ships, etc.), traffic signal equipment, crime and disaster prevention devices, electric power equipment, various safety devices, and medical equipment not directly targeted for life support

Specified Standards: Aircraft equipment, aeronautical and space equipment, seabed relay equipment, nuclear power control systems, and medical equipment, devices and systems for life support

Before considering the use of our products under the following conditions, you must contact one of our customer service representatives without fail and exchange written specifications.

- (1) When our products are to be used in any of the applications listed for the Special Standards or Specified Standards
- (2) When, even for any of the applications listed for the Reference Standards, our products may possibly be used beyond the range of the specifications, environment or conditions listed in the document or when you are considering the use of our products in any conditions or an environment that is not listed in the document

Pressure Sensor PS/PF



High precision pressure sensor (without amp.)

Features

- Compact size (PS type)
- High accuracy and liner characteristic
- Broad line-up
- RoHS compliant

Typical Applications

- Industrial use: pressure switches and pneumatic components, compressed air pressure measuring devices and airbeds
- Medical use: blood pressure meters, oxygen generator and airbeds
- Others: pressure sensing devices for air pressure mediums

Ordering Information

ADP

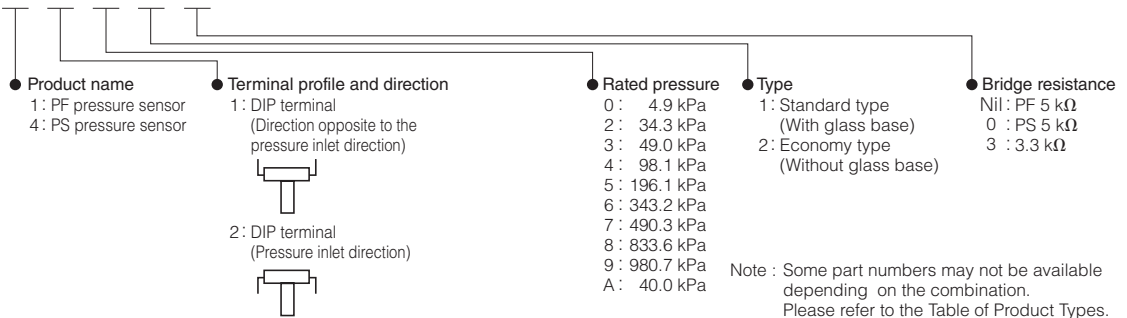

Types

Brige resistance		Part No.									
		PS pressure sensor					PF pressure sensor				
		5 kΩ		3.3 kΩ			5 kΩ		3.3 kΩ		
Pressure	Terminal										
		DIP terminal: Direction opposite to the pressure inlet direction	DIP terminal: Pressure inlet direction	SMD terminal	DIP terminal: Direction opposite to the pressure inlet direction	DIP terminal: Pressure inlet direction	DIP terminal: Direction opposite to the pressure inlet direction	DIP terminal: Pressure inlet direction	DIP terminal: Direction opposite to the pressure inlet direction	DIP terminal: Pressure inlet direction	DIP terminal: Direction opposite to the pressure inlet direction
Standard type (with glass base)	4.9kPa	ADP41010	ADP42010	—	—	—	ADP1101	ADP1201	—	—	
	34.3kPa	ADP41210	ADP42210	—	—	—	ADP1121	ADP1221	—	—	
	49.0kPa	ADP41310	ADP42310	—	—	—	ADP1131	ADP1231	—	—	
	98.1kPa	ADP41410	ADP42410	ADP4932	ADP41413	ADP42413	ADP1141	ADP1241	—	—	
	196.1kPa	ADP41510	ADP42510	—	—	—	ADP1151	ADP1251	—	—	
	343.2kPa	ADP41610	ADP42610	—	—	—	ADP1161	ADP1261	—	—	
	490.3kPa	ADP41710	ADP42710	—	—	—	ADP1171	ADP1271	—	—	
	833.6kPa	ADP41810	ADP42810	—	—	—	ADP1181	ADP1281	—	—	
Economy type (without glass base)	40.0kPa	ADP41910	ADP42910	ADP4933	ADP41913	ADP42913	ADP1191	ADP1291	—	—	
		—	—	—	ADP41A23	ADP42A23	—	—	ADP11A23	ADP12A23	

Standard packing : Carton : 100 pcs.; Case : 1,000 pcs.

Rating

Type	Standard type (With glass base)						Economy type (Without glass base)	
Type of pressure	Gauge pressure							
Pressure medium	Air *2							
Rated pressure (Unit: kPa)	4.9	34.3 to 343.2	490.3	833.6	980.7	98.1 *3	980.7 *3	40.0
Max. applied pressure	Twice of the rated pressure			1.5 times of the rated pressure		Twice of the rated pressure	1.5 times of the rated pressure	Twice of the rated pressure
Bridge resistance	5,000 Ω ±1,000 Ω					3,300 Ω ±700 Ω		3,300 Ω ±600 Ω
Ambient temperature	-20 °C to +100 °C -4 °F to +212 °F (no freezing or condensation)							-5 °C to +50 °C 23 °F to +122 °F
Storage temperature	-40 °C to +120 °C -40 °F to +248 °F (no freezing or condensation)							-20 °C to +70 °C -4 °F to +158 °F
Standard temperature	25 °C 77 °F					30 °C 86 °F		25 °C 77 °F
Temperature compensation range	0 °C to 50 °C 32 °F to +122 °F					0 °C to 60 °C 32 °F to +140 °F		5 °C to 45 °C 41 °F to +113 °F
Drive current (constant current)	1.5 mA.DC					1.0 mA.DC		1.5 mA.DC
Output span voltage	40±20 mV	100±40 mV				65±25 mV		43.5±22.5 mV
Offset voltage	±20 mV							±15 mV
Linearity	±0.7 %FS	±0.3 %FS	±0.5 %FS	±0.6 %FS		±1.0 %FS		±0.3 %FS
Pressure hysteresis	±0.6 %FS	±0.2 %FS	±0.4 %FS			±1.0 %FS		±0.7 %FS
Offset voltage-temperature characteristics *4	±15 %FS	±5.0 %FS				±3.5 %FS		±10 %FS
Sensitivity-temperature characteristics *4	±10 %FS	±2.5 %FS					±1.3 %FS	

Notes : *1 Unless otherwise specified, measurements were taken with a drive current of ±0.01 mA.DC and humidity ranging from 25% to 85%.

*2 Please consult us if a pressure medium other than air is to be used.

*3 For PS pressure sensor only

*4 This is the regulation which applies within the compensation temperature range.

*5 Please consult us if the intended use involves a negative pressure.

Reference Data

[PS pressure sensor]

● Characteristics data

1.-(1) Output characteristics

ADP41913

Drive current : 1.0 mA.DC ; temperature : 30 °C 86 °F

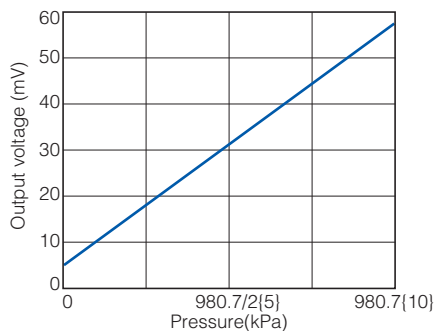

1.-(2) Offset voltage - temperature characteristics

ADP41913

Drive current : 1.0 mA.DC; rating ±3.5 %FS

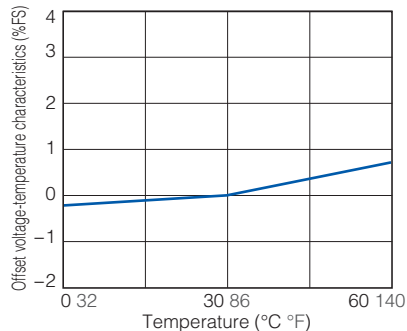

1.-(3) Sensitivity -temperature characteristics

ADP41913

Drive current : 1.0 mA.DC; rating ±2.5 %FS

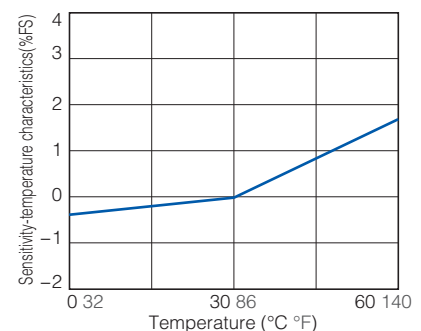

● Pressure cycle range (0 to rated pressure)

Tested sample : ADP41913, temperature : 100 °C 212 °F, No. of cycle: 1×10⁶

Offset voltage range

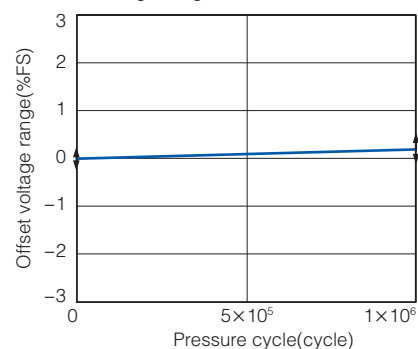

Output span voltage range

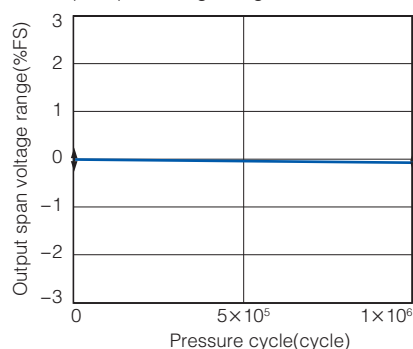

Even after testing for 1 million times, the variations in the offset voltage and output span voltage are minimal.

[PF pressure sensor]

● Characteristics data

1.-(1) Output characteristics

ADP1141

Drive current : 1.5 mA.DC; temperature : 30 °C 86 °F

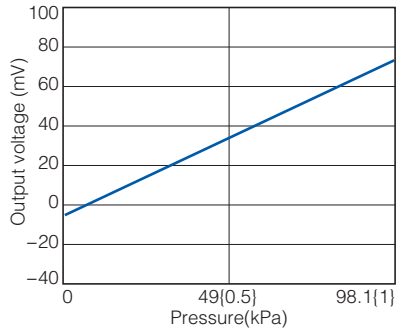

1.-(2) Offset voltage - temperature characteristics

ADP1141

Drive current : 1.5 mA.DC; rating ± 5 %FS

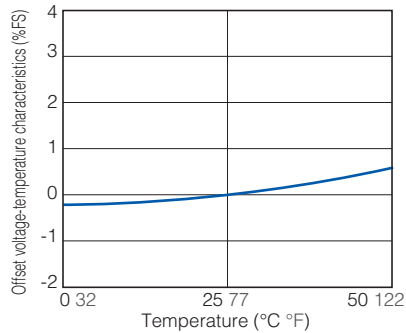

1.-(2) Sensitivity - temperature characteristics

ADP1141

Drive current : 1.5 mA.DC; rating ± 2.5 %FS

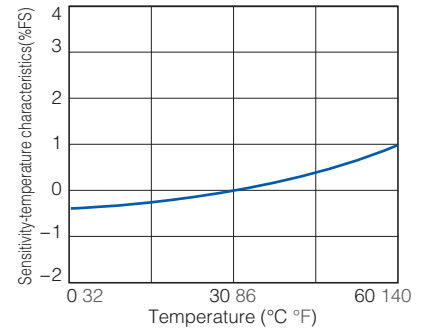

● Pressure cycle range (0 to rated pressure)

Tested sample : ADP1131, temperature : 25 °C 77 °F

Offset voltage range

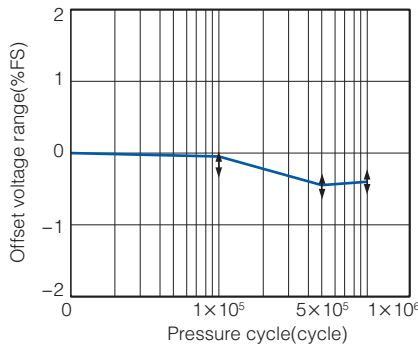

Output span voltage range

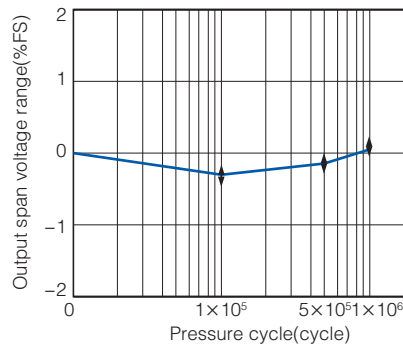

Even after testing for 1 million times, the variations in the offset voltage and output span voltage are minimal.

Evaluation Test

Classification	Tested item	Tested condition	Result
Environmental characteristics	Storage at high temperature	Temperature : Left in a 120 °C 248 °F constant temperature bath Time : 1,000 hrs.	Passed
	Storage at low temperature	Temperature : Left in a -40 °C -40 °F constant temperature bath Time : 1,000 hrs.	Passed
	Humidity	Temperature/humidity : Left at 40 °C 104 °F, 90 % RH Time : 1,000 hrs.	Passed
	Temperature cycle	Temperature : -40 °C to 120 °C -40 °F to 248 °F 1 cycle : 30 Min. Times of cycle : 100	Passed
Endurance characteristics	High temperature/ high humidity operation	Temperature/humidity : 40°C 104 °F, 90% RH Operation times : 10 ⁶ , rated voltage applied.	Passed
Mechanical characteristics	Vibration resistance	Double amplitude : 1.5 mm 0.059 inch Vibration : 10 to 55 Hz Applied vibration direction : X, Y, Z 3 directions Times : 2 hrs each	Passed
	Dropping resistance	Dropping height : 75 cm 29.528 inch Times : 2 times	Passed
	Terminal strength	Pulling strength : 9.8 N {1 kgf}, 10 sec. Bending strength : 4.9 N {0.5 kgf}, left and right 90 ° 1 time	Passed
Soldering resistance	Soldered in DIP soldering bath	Temperature : 230 °C 446 °F Time : 5 sec.	Passed
	Temperature	Temperature : 260°C 500 °F Time : 10 sec.	Passed

Note: For details other than listed above, please consult us.

Items	Criteria
Offset voltage Output span voltage	Variation amount within ± 5.0 %FS of value

Dimensions

The CAD data of the products with a **CAD Data** mark can be downloaded from: <http://industrial.panasonic.com/>

[PF pressure sensor]

- Terminal direction : DIP terminal Direction opposite to the pressure inlet direction ADP11□□(□)

CAD Data

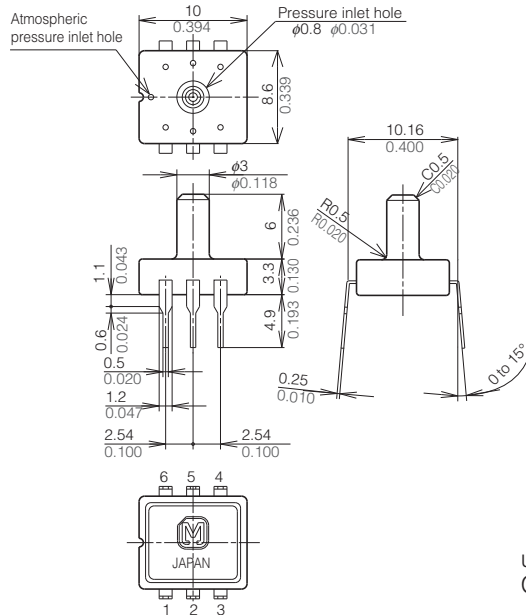

Recommended PC board pattern (BOTTOM VIEW)

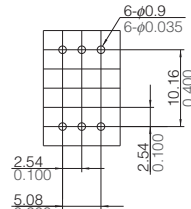

Tolerance : ±0.1

unit : mm inch
General tolerance : ±0.3 ±0.012

Terminal connection diagram

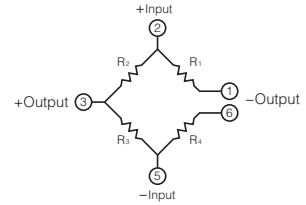

Terminal No.	Name
1	Output (-)
2	Power supply (+)
3	Output (+)
4	No connection
5	Power supply (-)
6	Output (-)

Note: Leave terminal 4 unconnected.

- Terminal direction : DIP terminal Pressure inlet direction ADP12□□(□)

CAD Data

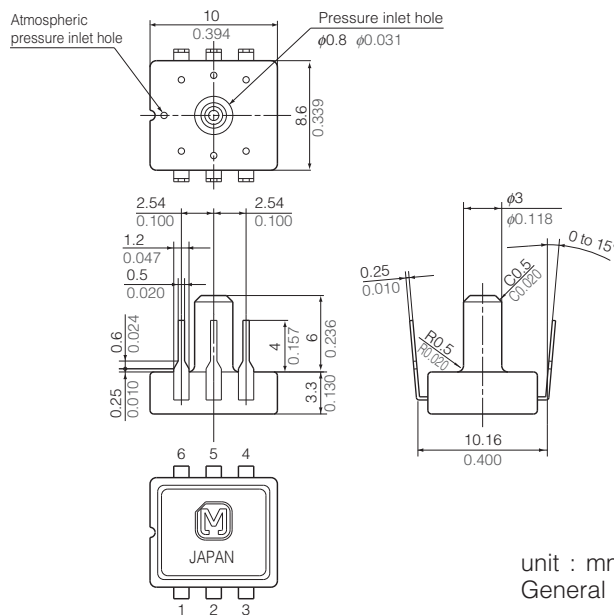

Recommended PC board pattern (BOTTOM VIEW)

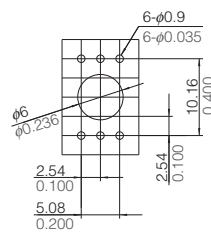

Tolerance : ±0.1

unit : mm inch
General tolerance : ±0.3 ±0.012

Terminal connection diagram

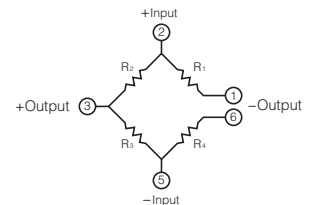

Terminal No.	Name
1	Power supply (+)
2	Output (+)
3	Power supply (-)
4	Power supply (-)
5	Output (-)
6	No connection

Note: Leave terminal 4 unconnected.

NOTES

■ Mounting

Use the land of the printed-circuit board on which the sensor is securely fixed.

■ Soldering

Avoid the external thermal influence as the product has a limited thermal capacity due to its compact structure. Heat deformation may damage the sensor or deteriorate its performance. Use the non-corrosive rosin flux. Prevent the flux from entering into the inside of the product as the sensor is exposed to the atmosphere.

- 1) Manual soldering
 - Raise the temperature of the soldering tip between 260 and 300 °C 500 and 572 °F (30 W) and solder within 5 seconds.
 - The sensor output may vary if the load is applied on the terminal during soldering.
 - Keep the soldering tip clean.
- 2) DIP soldering (DIP Terminal)
 - Keep the temperature of the DIP solder tank below 260 °C 500 °F and solder within 5 seconds.
 - To avoid heat deformation, do not perform DIP soldering when mounting on the circuit board which has a small thermal capacity.
- 3) Reflow soldering (SMD Terminal)
 - The recommended reflow temperature profile conditions are given below.

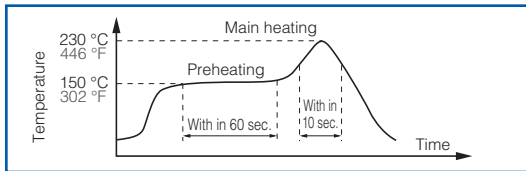

- We recommend the screen solder printing method as the method of cream.
 - Please refer to the recommended PC board specification diagram for the PC board foot pattern.
 - Self alignment may not always work as expected, therefore, please carefully the position of the terminals and pattern.
 - The temperature of the profile is assumed to be a value measured with the printed wiring board of the terminal neighborhood.
 - Please evaluate solderability under the actual mounting conditions since welding and deformation of the pressure inlet port may occur due to heat stress depending on equipments or conditions.
- 4) Rework soldering
 - Complete rework at a time.
 - Use a flattened soldering tip when performing rework on the solder bridge. Do not add the flux.
 - Keep the soldering tip below the temperature described in the specifications.
 - 5) Avoid drop and rough handling as excessive force may deform the terminal and damage soldering characteristics.
 - 6) Keep the circuit board warpage within 0.05 mm of the full width of the sensor.
 - 7) After soldering, do not apply stress on the soldered part when cutting or bending the circuit board.
 - 8) Prevent human hands or metal pieces from contacting with the sensor terminal.
Such contact may cause anomalous outlets as the terminal is exposed to the atmosphere.

- 9) After soldering, prevent chemical agents from adhering to the sensor when applying coating to avoid insulation deterioration of the circuit board.
- 10) Please consult us concerning leadfree soldering.

■ Cleaning

- Prevent cleaning liquid from entering the inside of the product as the sensor is exposed to the atmosphere.
- Do not perform ultrasonic cleaning in order to prevent damages to the product.

■ Environment

- 1) Avoid use and storage in the corrosive gas (organic solvent, sulfurous acid and hydrogen sulfide gases) which negatively affects the product.
- 2) Avoid use in a place where these products come in contact with water as the sensor does not have a splash-proof construction.
- 3) Avoid use in an environment where these products cause dew condensation.
When water attached to the sensor chip freezes, the sensor output may be fluctuated or damaged.
- 4) Due to the structure of the pressure sensor chip, the output varies under light.
Do not expose the sensor chip to light when applying a voltage by using a transparent tube.
- 5) Do not apply high-frequency oscillation, such as ultrasonic waves, to the product.

■ Quality check under actual use conditions

These specifications are for individual components. Before use, carefully check the performance and quality under actual use conditions to enhance stability.

■ Other precautions

- 1) The wrong mounting method and the pressure range may invite the risk of accidents.
- 2) Only applicable pressure medium is dry air. Avoid use in the corrosive gas (organic solvent, sulfurous acid and hydrogen sulfide gases) or other mediums containing moisture or foreign substances. Such mediums may damage or break the product.
- 3) The pressure sensor chip is located inside the pressure introduction port. Do not insert foreign substances, such as wires, into the port as those substances may damage the chip and close the port. Do not block the atmosphere introduction port.
- 4) Use electric power within the rated power range. Use beyond the range may damage the product.
- 5) Follow below instructions as static electricity may damage the product:
 - (1) For Storage, short the circuit between terminals by using conductive substances or wrap the whole chip with aluminum foil. For storage and transportation, avoid plastic containers which are easily electrified.
 - (2) Before use, connect electrified materials on desk and operators to the ground in order to safely discharge static electricity.
- 6) Carefully select and fix tubes, introduction pipes and products based on the working voltage. Please contact us for any inquiries.

APPLICATION CIRCUIT DIAGRAM (EXAMPLE)

The pressure sensor converts a voltage by constant current drive and if necessary, amplifies the voltage. The circuit on the right is a typical use example.

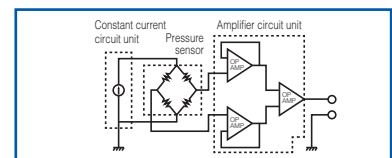

MOUNTING METHOD

The general method of air pressure transmission varies depending on the low/high pressure condition.

• Usage note

- (1) Select a sturdy pressure introduction pipe to avoid pressure leak.
- (2) Securely fix the pressure introduction pipe to avoid pressure leak.
- (3) Do not block the pressure introduction pipe.

Methods of transmitting air pressures

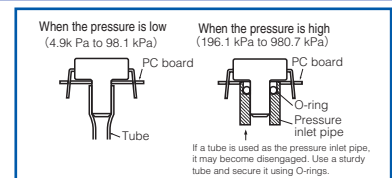

EXPLANATION OF TERMS

■ Pressure object

This is what can be used to activate the pressure sensor.

(The Panasonic Corporation pressure sensor can be used with gas.)

■ Rated pressure

The pressure value up to which the specifications of the pressure sensor are guaranteed.

■ Maximum applied pressure

The maximum pressure that can be applied to the pressure sensor, after which, when the pressure is returned to below the rated pressure range, the specifications of the pressure sensor are guaranteed.

■ Temperature compensation range

The temperature range across which the specification values of the pressure sensor are guaranteed.

■ Drive current (voltage)

The supply current (voltage) required to drive a pressure sensor.

■ Output span voltage

The difference between the rated output voltage and the offset voltage. The output span voltage is also called the full-scale voltage (FS).

■ Offset voltage

The output voltage of a pressure sensor when no pressure is applied.

■ Rated pressure output voltage

Output voltage when rated pressure is applied.

■ Linearity

When the pressure is varied from no load to the rated pressure, the linearity is the amount of shift between the straight line that joins the no-load voltage value and the rated pressure voltage value (expressed as the ratio of the amount of shift (D1) at half of the rated pressure value with respect to the full scale voltage (FS)).

■ Output hysteresis

The ratio of the difference (D2) in the no-load output voltages when the pressure is varied from no load to the rated pressure then reduced back to no load, with respect to the full scale voltage (FS).

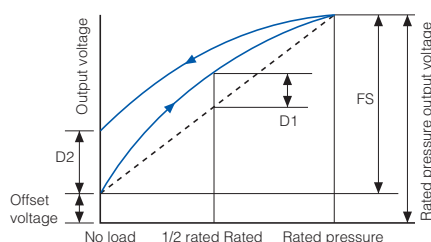

■ Offset voltage temperature characteristic

The variation of the offset voltage with changes in ambient temperature. The difference between the offset voltage at the standard temperature and the offset values at the compensation lower limit temperature (low temperature) (D1) and compensation upper limit temperature (high temperature) (D2) are obtained, and the offset voltage temperature characteristic is expressed as the ratio of the larger of these two differences (absolute) with respect to the full scale voltage (FS).

■ Temperature sensitivity characteristic

The variation of the sensitivity with changes in ambient temperature (variation in full scale (FS)). The difference between the full scale voltage at the standard temperature (FS) and the full scale values at the compensation lower limit temperature (low temperature) (FS1) and compensation upper limit temperature (high temperature) (FS2) are obtained, and the offset voltage temperature characteristic is expressed as the ratio of the larger of these two differences (FS1 - FS and FS2 - FS (absolute)) with respect to the full scale voltage (FS).

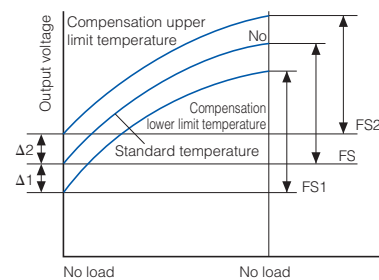

■ Bridge resistance

Refers to the resistance value of a piezoresistance formed on a monolithic silicon substrate.

For example, the values of the resistances R1 to R4 in the bridge are typically 5 kΩ each.

* When the resistances of the resistive elements R1 to R4 that comprise the bridge are 5 kΩ each, the equivalent composite resistance of the bridge is 5 kΩ (3 kΩ bridges are also available).

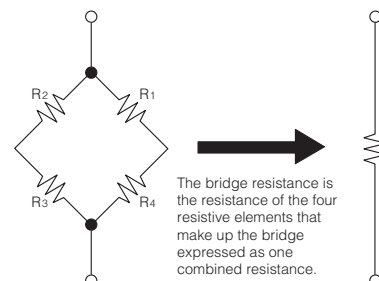

■ Overall accuracy

Accuracy of offset voltage and rated pressure output voltage within the temperature compensation range.

Please contact

Panasonic Corporation

■ Head Office: 1006, Kadoma, Kadoma-City, Osaka 571-8506, Japan
■ Telephone: +81-6-6906-4736
industrial.panasonic.com/ww

Panasonic[®]

© Panasonic Corporation.2017