

SPECIFICATION

Part No. : **MA106.C.LB.001**

Product Name : MA106 GPS/GLONASS/GALILEO and Cellular
2in1 Combination Hercules
Screw-mount (Permanent mount)

Feature : Low profile - Height 29 mm and Diameter 49mm
Heavy duty screw mount
UV and vandal resistant PC housing

Cellular -Penta Band Antenna
850/900/1800/1900/2100
GSM/GPRS/CDMA/EVDO/UMTS/HSPA/WCDMA
Cellular - 3 Meters Low Loss CFD200 SMA(M)

GPS/GALILEO -1575.42MHz - Two Stage 27dB+ LNA
GLONASS - 1602MHz - Two Stage 27dB+ LNA
GPS/GLONASS/GALILEO - 3 Meters RG174 SMA(M)
IP67 & IP69K compliant
Cables and connectors are fully customizable
ROHS Compliant





1. Introduction

The MA106.C GPS/GLONASS/GALILEO and Cellular Combination Hercules Antenna is the newest upgraded model of Taoglas' popular Hercules series. It is a combination 2in1 high performance GPS/GLONASS/GALILEO and penta-band cellular antenna solution for the most reliable asset tracking and remote monitoring. The GPS/GLONASS/GALILEO antenna and LNA have been optimized to provide excellent performance.

The penta-band cellular antenna delivers high efficiency at all common 3G/2G bands worldwide, making it ideal for use on GSM, GPRS, and CDMA systems.

Durable UV and robust PC housing is resistant to vandalism and direct attack. At only 29 mm in height, it complies with the latest EU height restriction directives for roof-mounted objects, with a diameter of 49 mm. It is designed to be covert and not catch on tree branches.

The Hercules can be mounted on metal or non-metal structures as it has a metal ground-plane base integrated inside. A waterproof closed cell foam seal under the base adheres to the surface it is mounted on and can stretch to fit curved surfaces typical on vehicles, preventing water from penetrating any mounting hole.

2. Specification

ELECTRICAL CELLULAR						
Standard		CLR	GSM	DCS (AWS)	PCS	IMT (AWS)
Band (MHz)		850	900	1800	1900	2100
Frequency (MHz)		824-896	880-960	1710-1880	1850-1990	1920 – 2170
Return Loss (dB)						
Cable length (meter)	0.3	-6.5	-6.0	-8	-7	-5
	1.0	-9.5	-8	-16	-17	-15
	2.0	-10	-9	-21	-20	-18
	3.0	-13	-11	-21	-21	-19
	5.0	-14	-14	-25	-25	-23
Efficiency (%)						
Cable length (meter)	0.3	38	54	54	58	50
	1.0	31	35	42	36	31
	2.0	23	20	32	23	21
	3.0	25	29	22	23	18
	5.0	11	11.5	11	12	11
Peak Gain (dBi)						
Cable length (meter)	0.3	2.0	3.3	3.6	4.0	3.0
	1.0	1.2	1.3	1.8	2	1.2
	2.0	0.5	-0.35	1.5	0	-0.1
	3.0	0.1	1.6	0.1	0.6	-0.9
	5.0	-2.5	-2.4	-3.0	-2.3	-2.0
Polarization		Linear				
Impedance		50 Ohms				
Input Power		10 Watts max.				
VSWR		<3.5.0:1				

ELECTRICAL GPS/GALILEO & GLONASS			
Frequency	1574~1610MHz		
Impedance	50 ohm		
VSWR	2.0 Max		
GPS/GALILEO Patch Gain@ Zenith	1575.42MHZ:2.5dBi Typ. @zenith		
GLONASS Patch Gain@ Zenith	1602MHZ:2.0dBi Typ. @zenith		
Out of Band Rejection	fo = 1592MHz fo ± 140 MHz 15dB Min.		
Input Voltage	Min:1.8V	Typ. 3.0V	Max:5.5V
Total Gain @ Zenith	22dB	28dB	31dB
Current Consumption	5mA	10mA	23mA
Noise Figure	2.6dB	2.6dB	2.9dB
MECHANICAL			
Dimensions	Height 28.5mm x Diameter 49.2mm		
Casing	UV resistant PC		
Base and thread	Nickel plated steel		
Thread diameter	18mm		
Weather proof gasket	CR4305 foam with 3M 9448WC double-side adhesive		
Cable pull	8 Kgf		
Recommended Mounting Torque	95Nm		
Maximum Mounting Torque	135Nm		

ENVIRONMENTAL	
Waterproof	IP-67 & IP-69K
Corrosion	5% NaCl for 48hrs - Nickel plated steel base and thread
Temperature Range	-40°C to +85°C
Thermal Shock	100 cycles -40°C to +80°C
Humidity	Non-condensing 65°C 95% RH
Shock (drop test)	1m drop on concrete 6 axes

*Note: The return loss, efficiency, and gain measurements in the above table were taken with the antenna mounted on a 30x30 cm metal plate. For specific case performance, refer to the plots below.

3. Test Setup

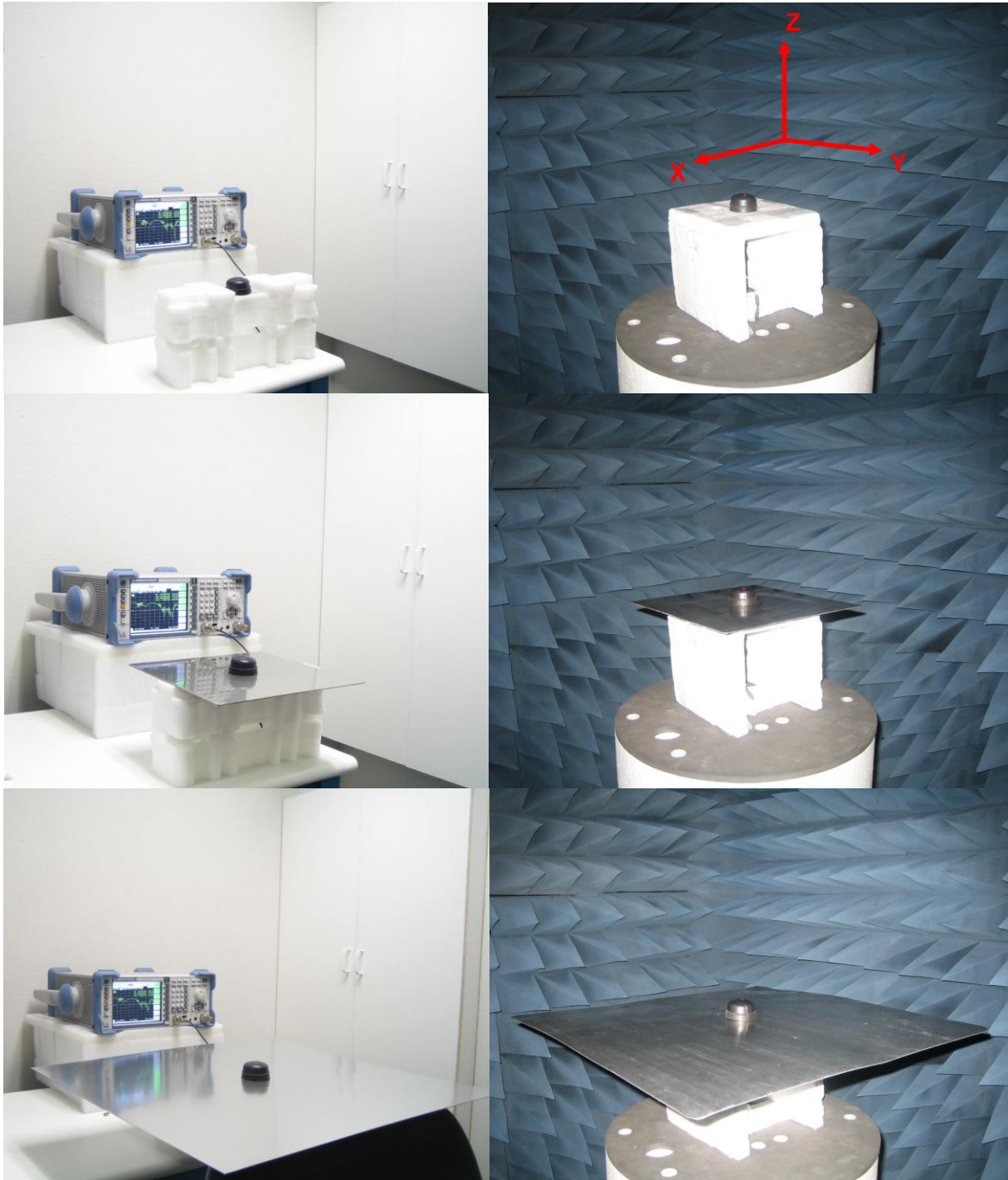

Figure 1. MA106 Antenna test setup in free space, 30x30 cm metal plate and 60x60 cm metal plate, R&S ZVL6 VNA (left) and R&S 4100 CTIA 3D Chamber (Right).

4. Cellular Antenna Parameters

4.1 Return Loss

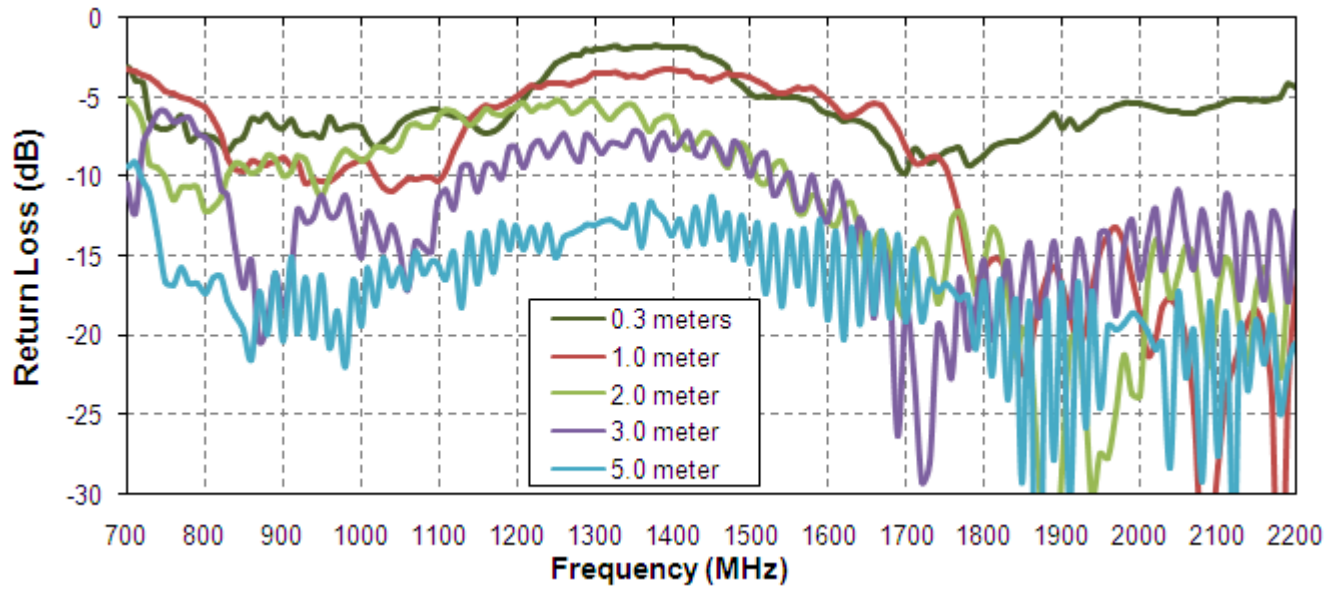

Figure 2. Return Loss of the MA106 antenna in free space.

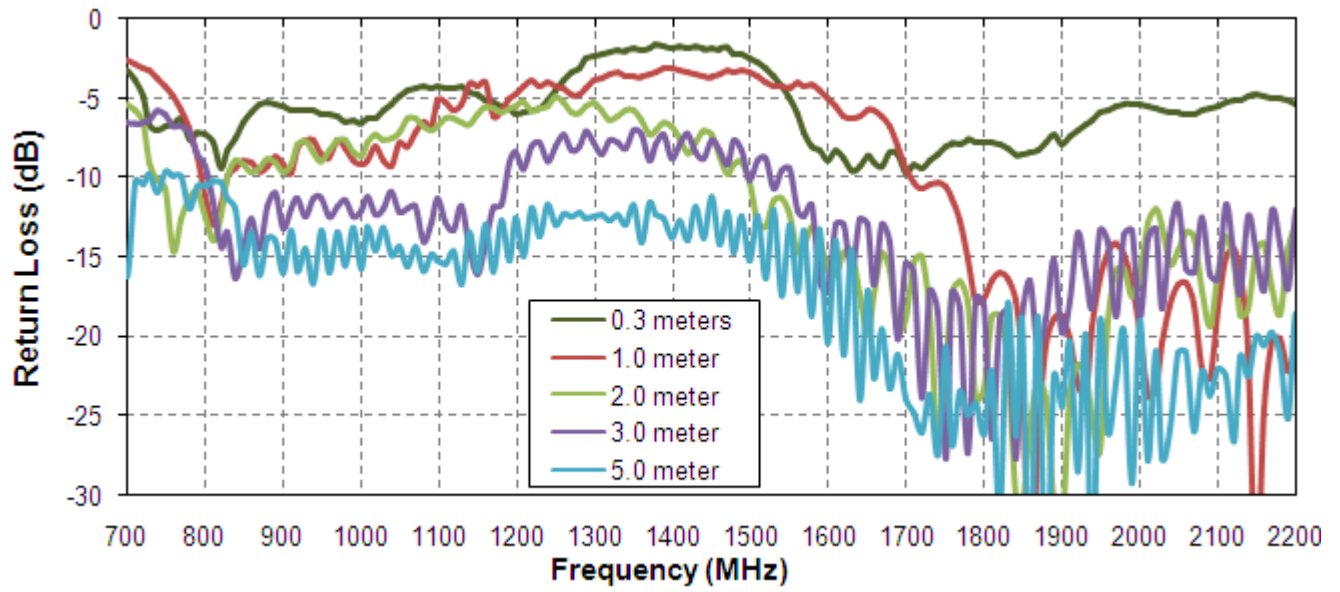

Figure 3. Return Loss of the MA106 antenna on 30*30cm metal plate.

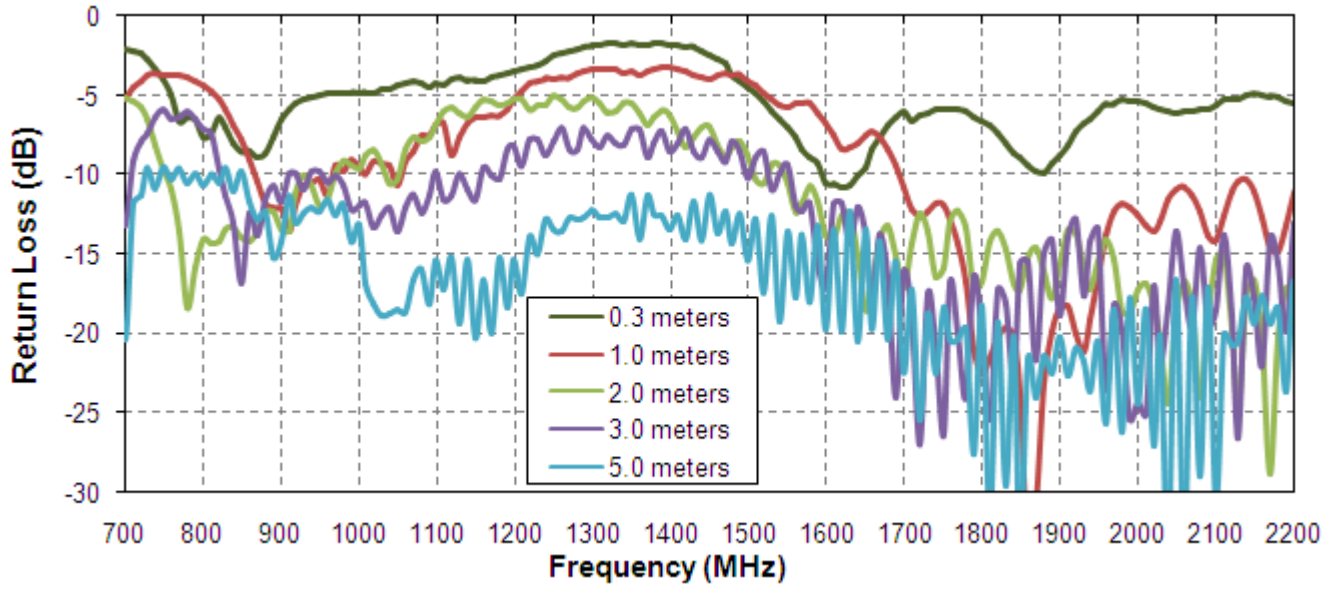

Figure 4. Return Loss of the MA106 antenna on 60*60cm metal plate.

4.2 Efficiency

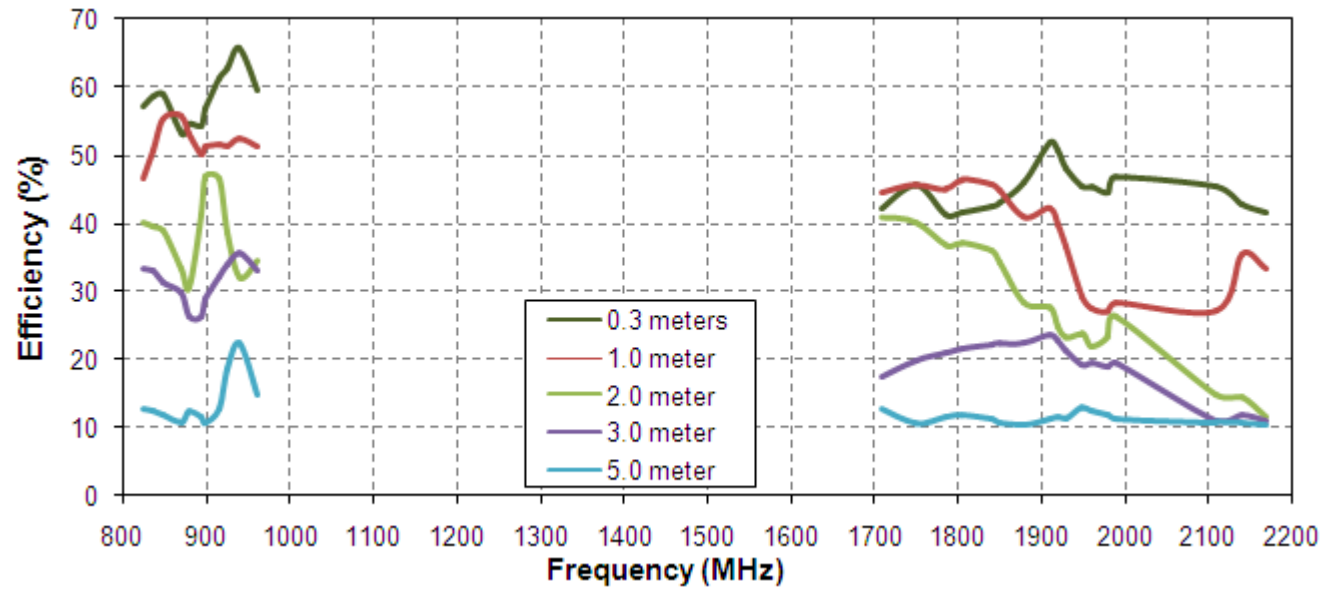

Figure 5. Efficiency of the MA106 antenna in free space.

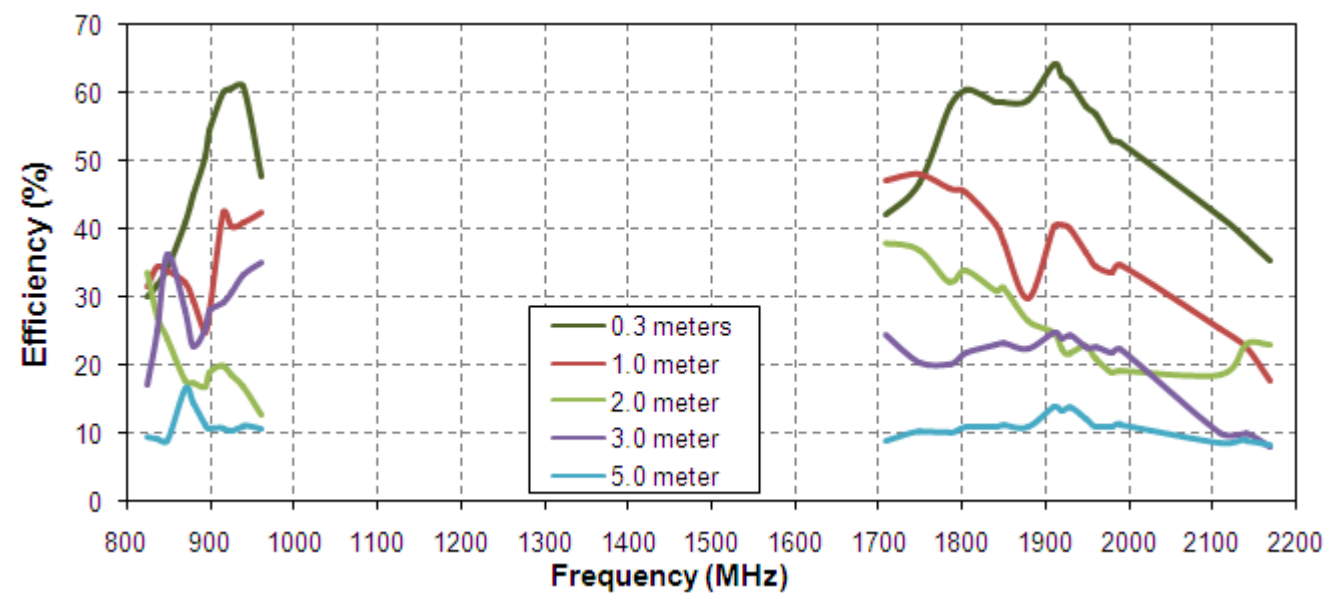

Figure 6. Efficiency of the MA106 antenna on 30*30cm metal plate.

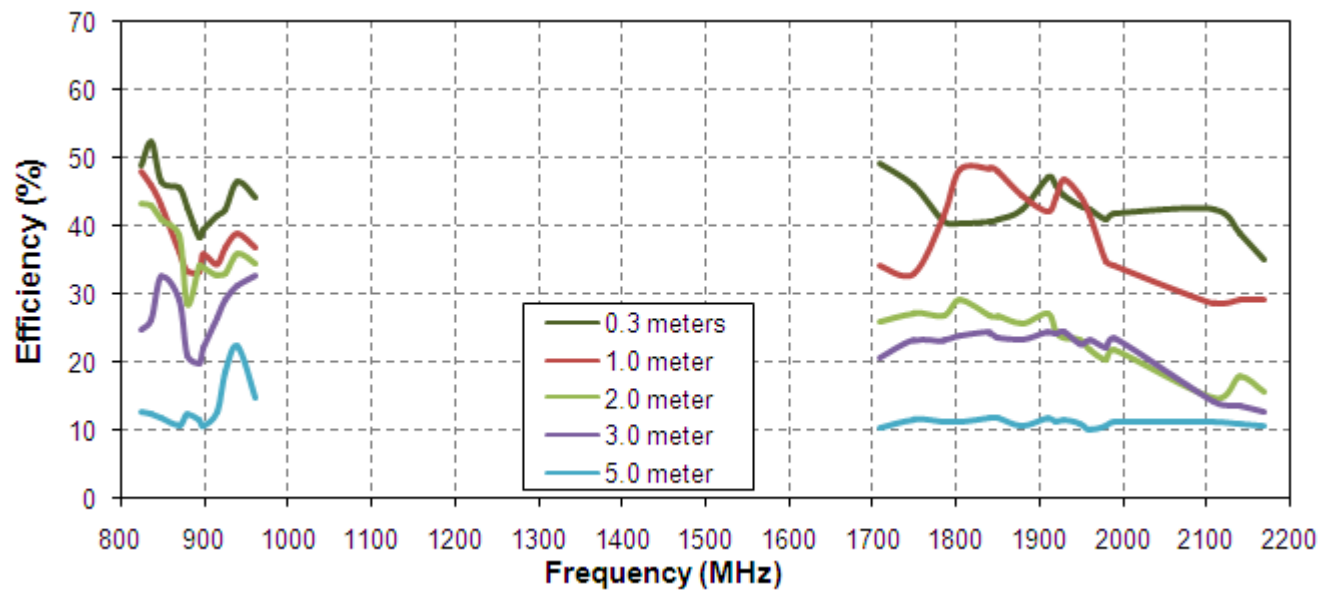

Figure 7. Efficiency of the MA106 antenna on 60*60cm metal plate.

4.3 Peak Gain

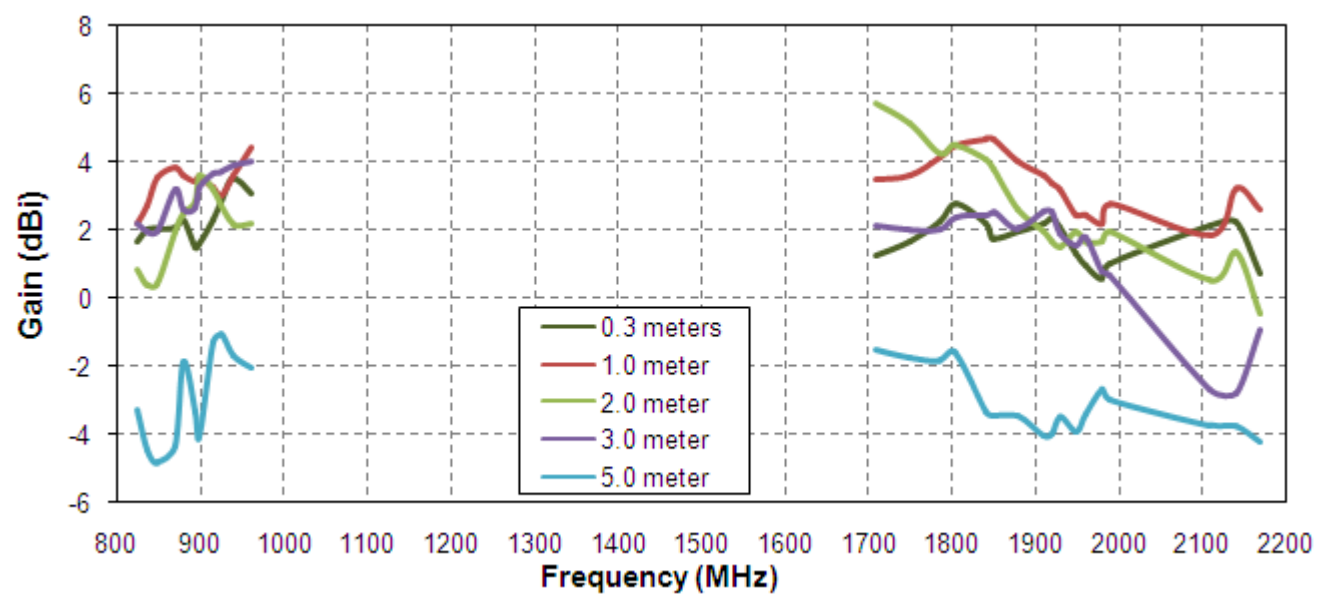

Figure 8. Gain of the MA106 antenna in free space.

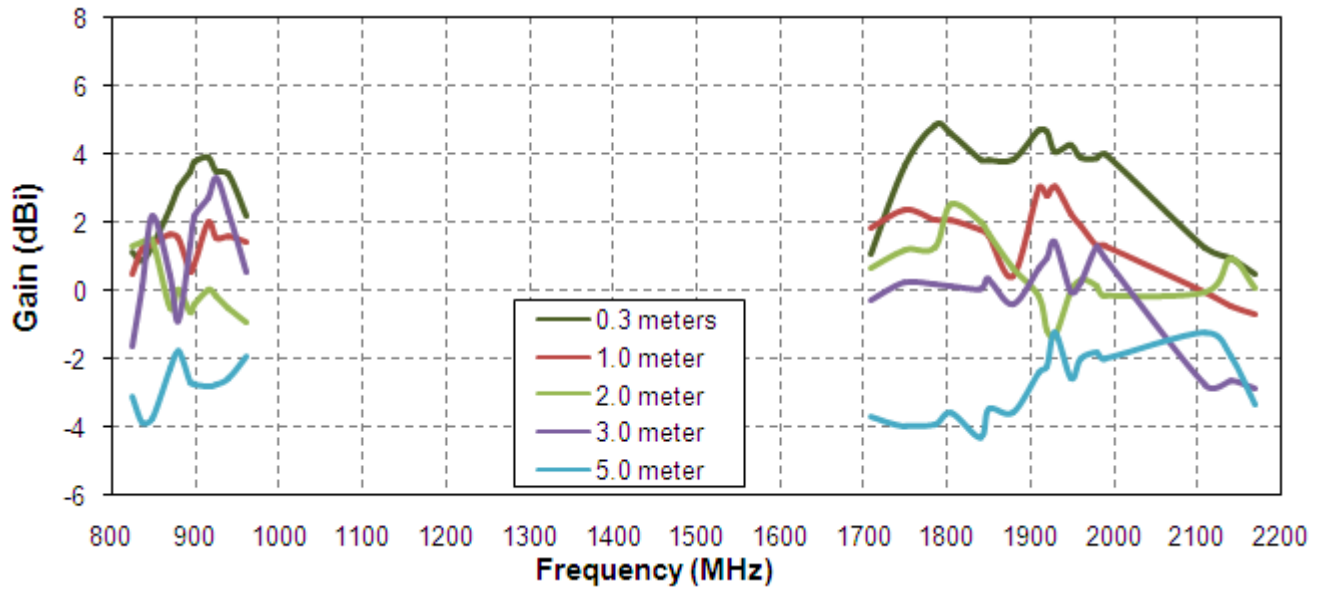

Figure 9. Gain of the MA106 antenna on 30*30cm metal plate.

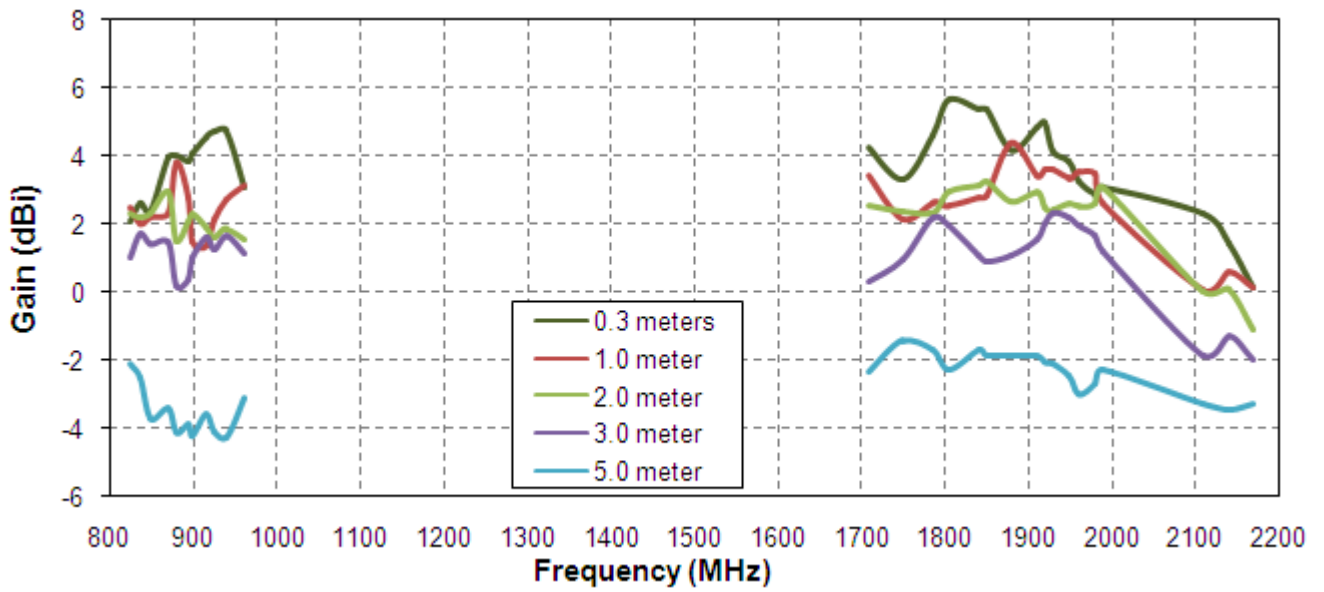

Figure 10. Gain of the MA106 antenna on 60*60cm metal plate.

4.4 Radiation pattern

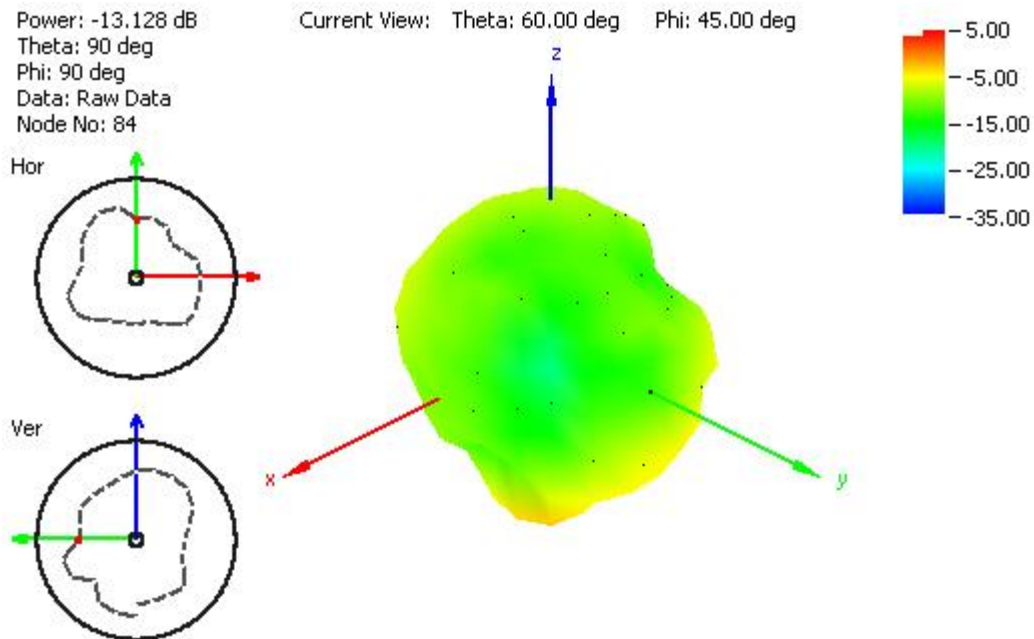

Figure 11. Radiation pattern at 849 MHz, Figure 1 as reference (dB), with 2 m RG174 cable and free space.

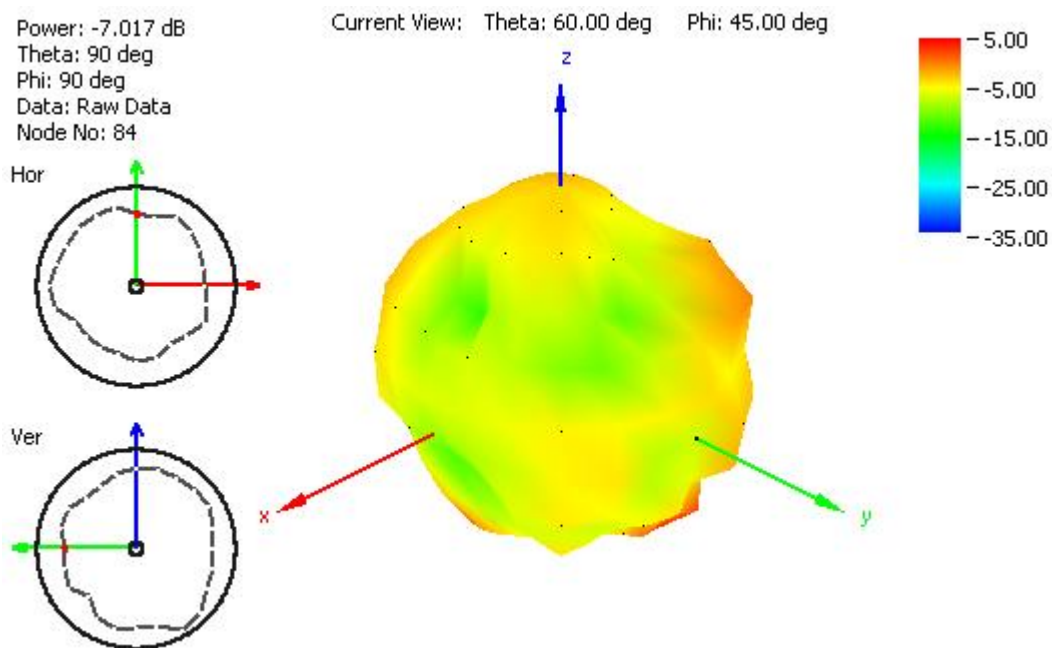

Figure 12. Radiation pattern at 915 MHz, Figure 1 as reference (dB), with 2 m RG174 cable and free space.

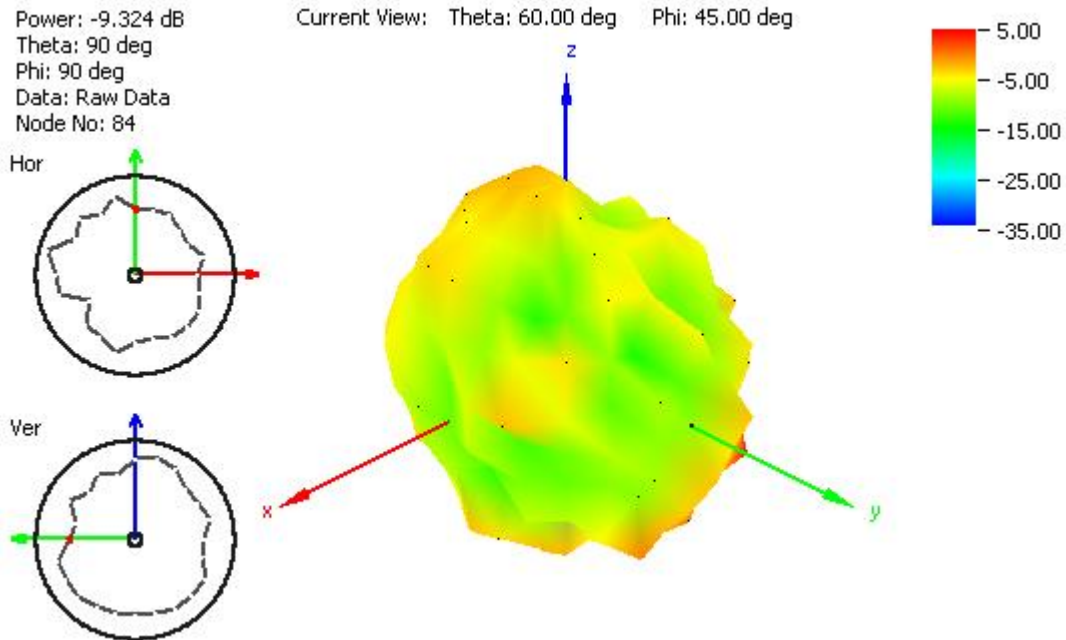

Figure 13. Radiation pattern at 1805 MHz, Figure 1 as reference (dB), with 2 m RG174 cable and free space.

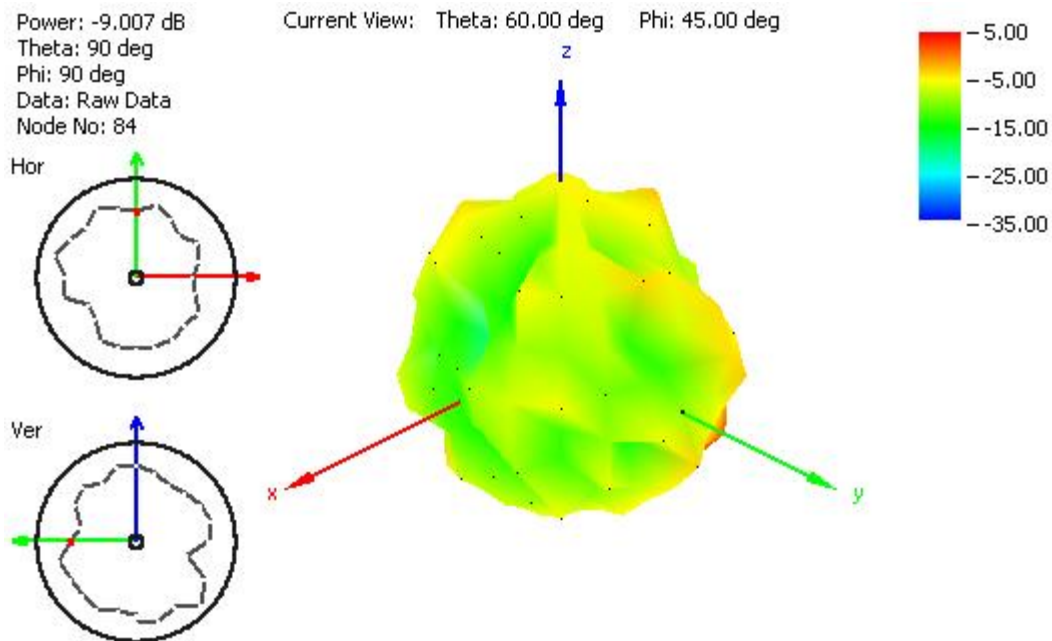

Figure 14. Radiation pattern at 1910 MHz, Figure 1 as reference (dB), with 2 m RG174 cable and free space.

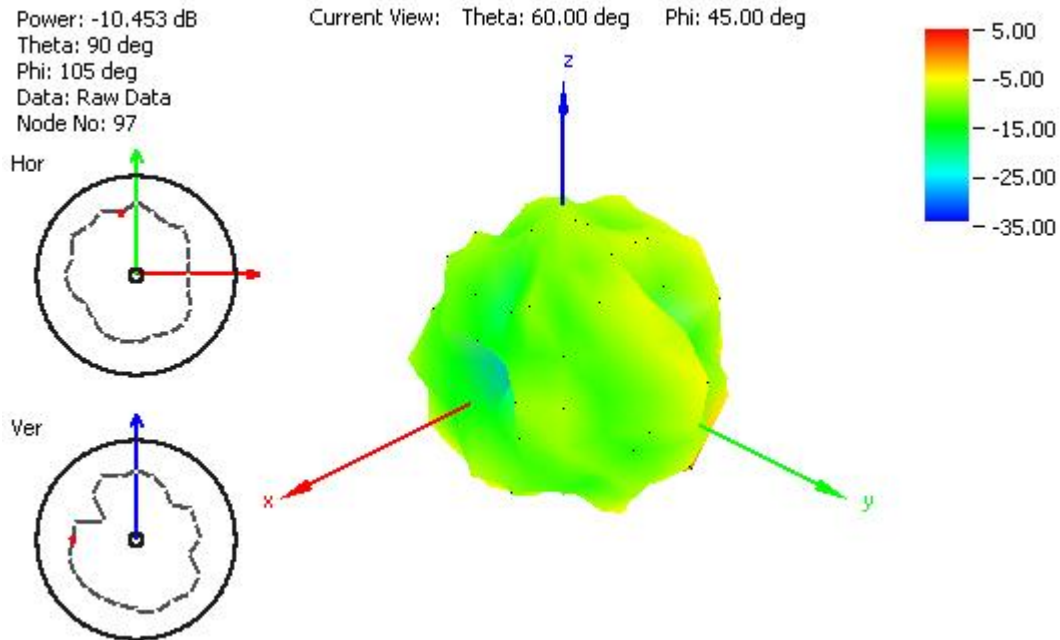

Figure 15. Radiation pattern at 2110 MHz, Figure 1 as reference (dB), with 2 m RG174 cable and free space.

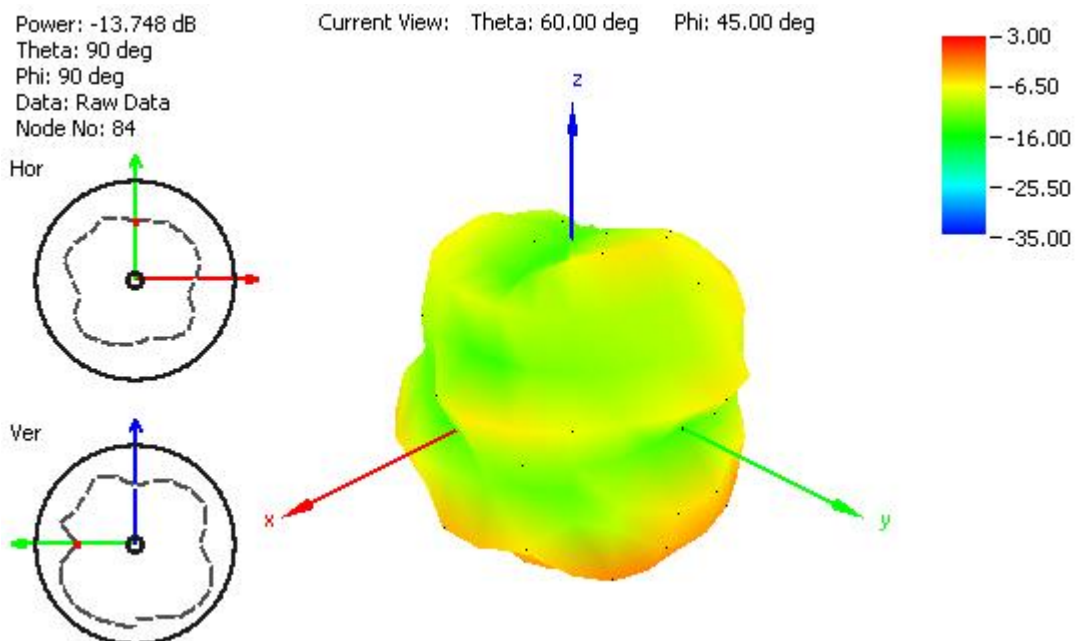

Figure 16. Radiation pattern at 849 MHz, Figure 1 as reference (dB), with 2 m RG174 cable and 30x30 cm metal plate.

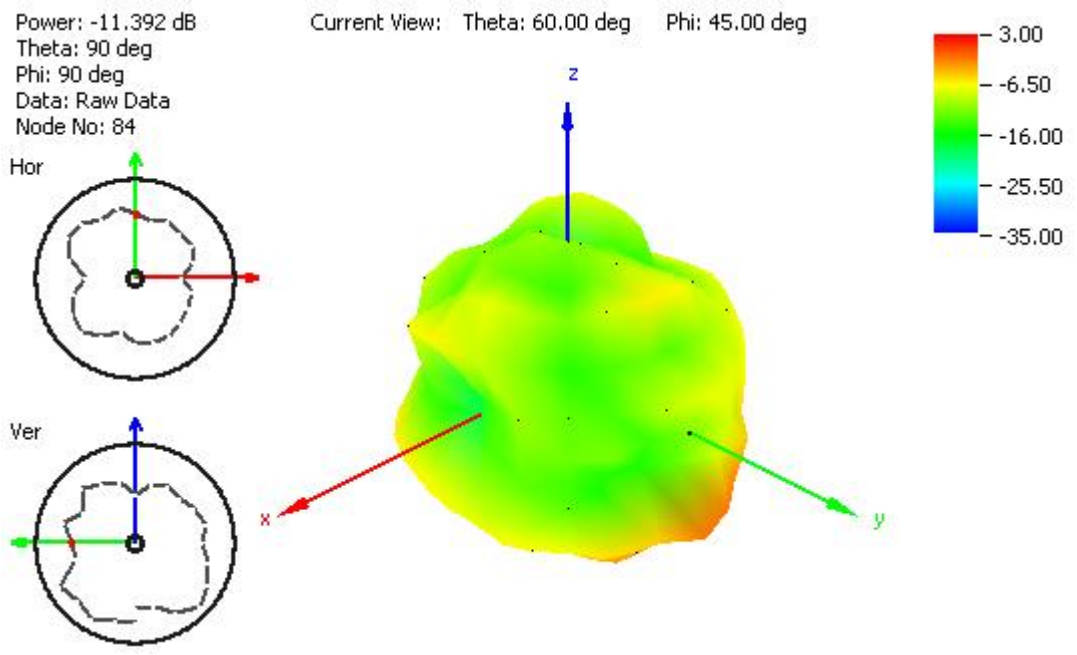

Figure 17. Radiation pattern at 915 MHz, Figure 1 as reference (dB), with 2 m RG174 cable and 30x30 cm metal plate.

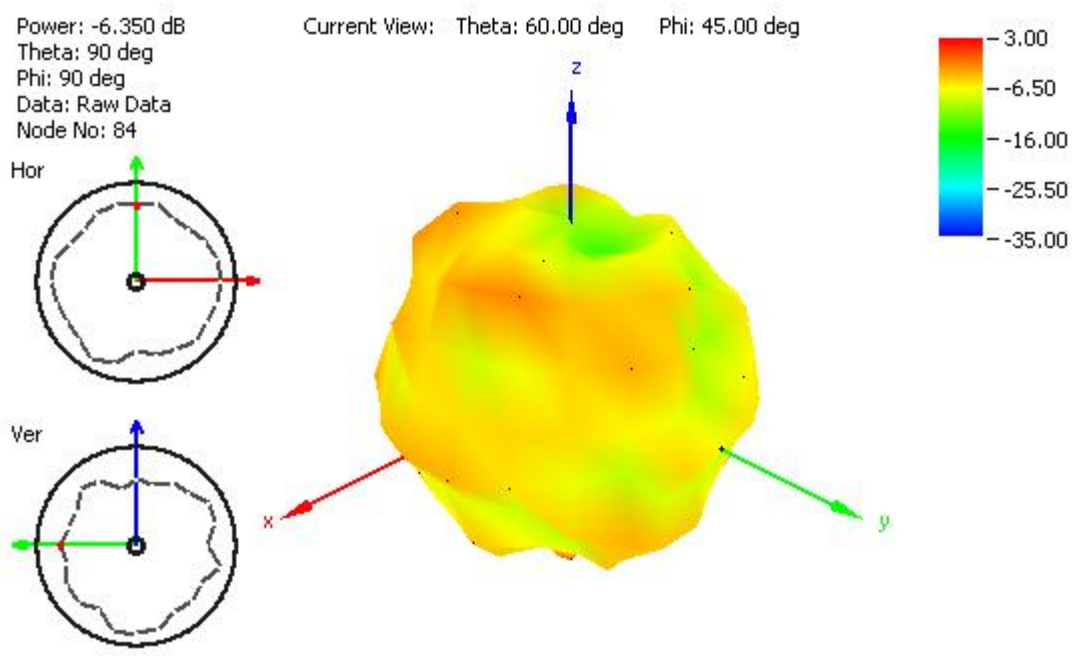

Figure 18. Radiation pattern at 1805 MHz, Figure 1 as reference (dB), with 2 m RG174 cable and 30x30 cm metal plate.

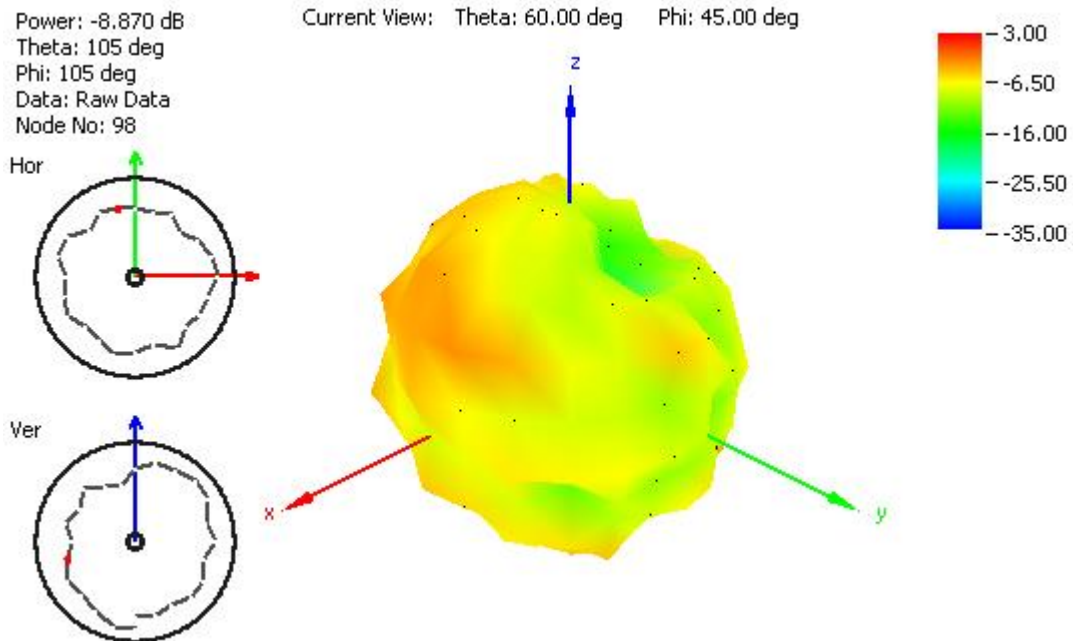

Figure 19. Radiation pattern at 1910 MHz, Figure 1 as reference (dB), with 2 m RG174 cable and 30x30 cm metal plate.

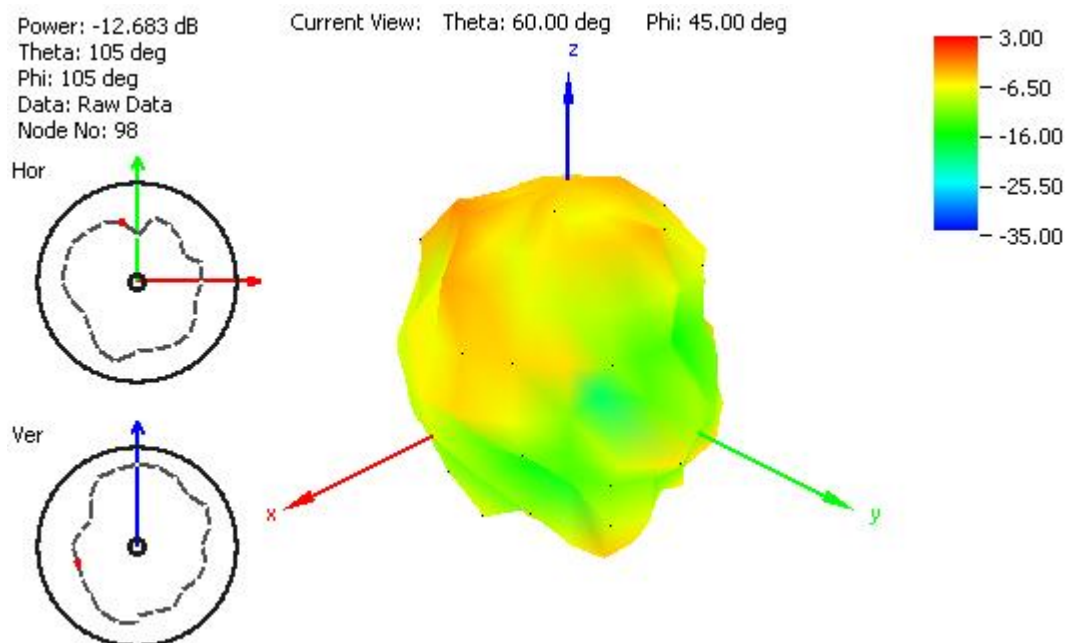

Figure 20. Radiation pattern at 2110 MHz, Figure 1 as reference (dB), with 2 m RG174 cable and 30x30 cm metal plate.

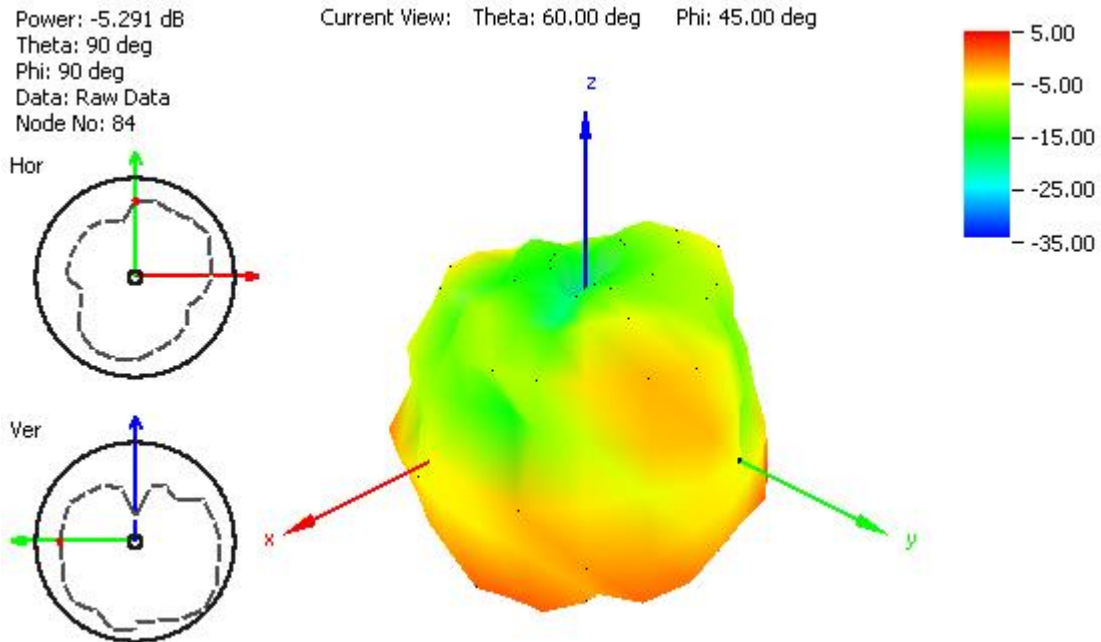

Figure 21. Radiation pattern at 849 MHz, Figure 1 as reference (dB), with 2 m RG174 cable and 60x60 cm metal plate.

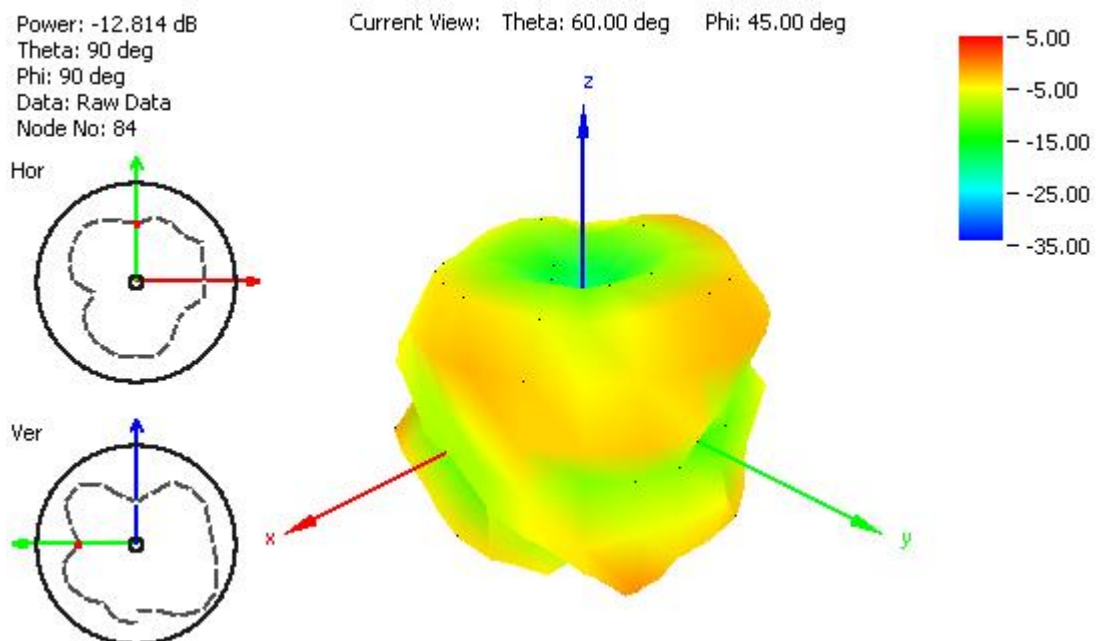

Figure 22. Radiation pattern at 915 MHz, Figure 1 as reference (dB), with 2 m RG174 cable and 60x60 cm metal plate.

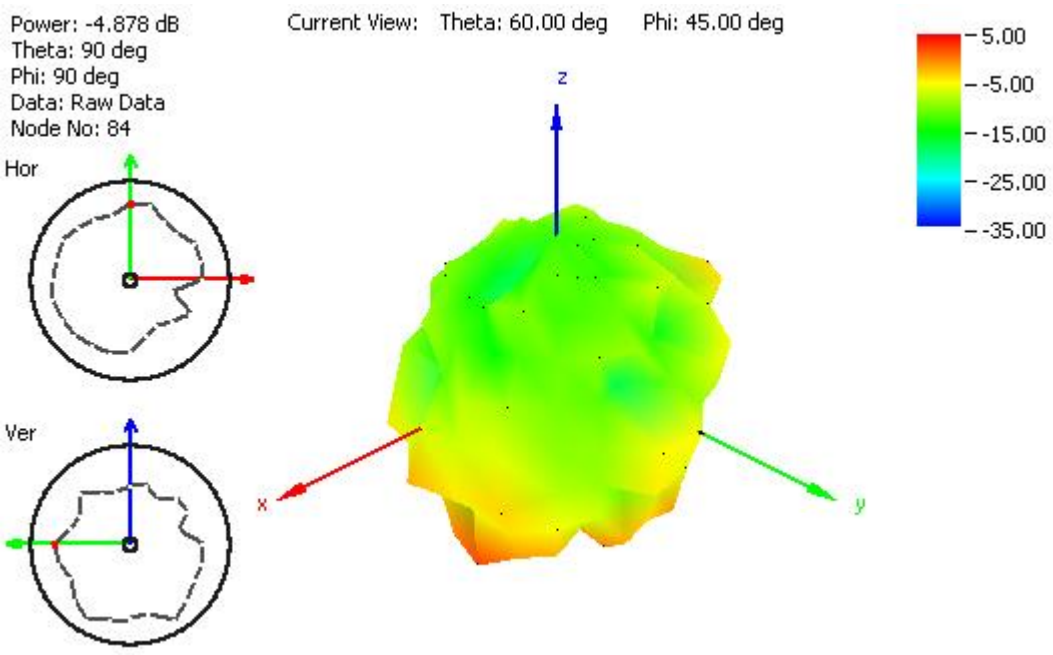

Figure 23. Radiation pattern at 1805 MHz, Figure 1 as reference (dB), with 2 m RG174 cable and 60x60 cm metal plate.

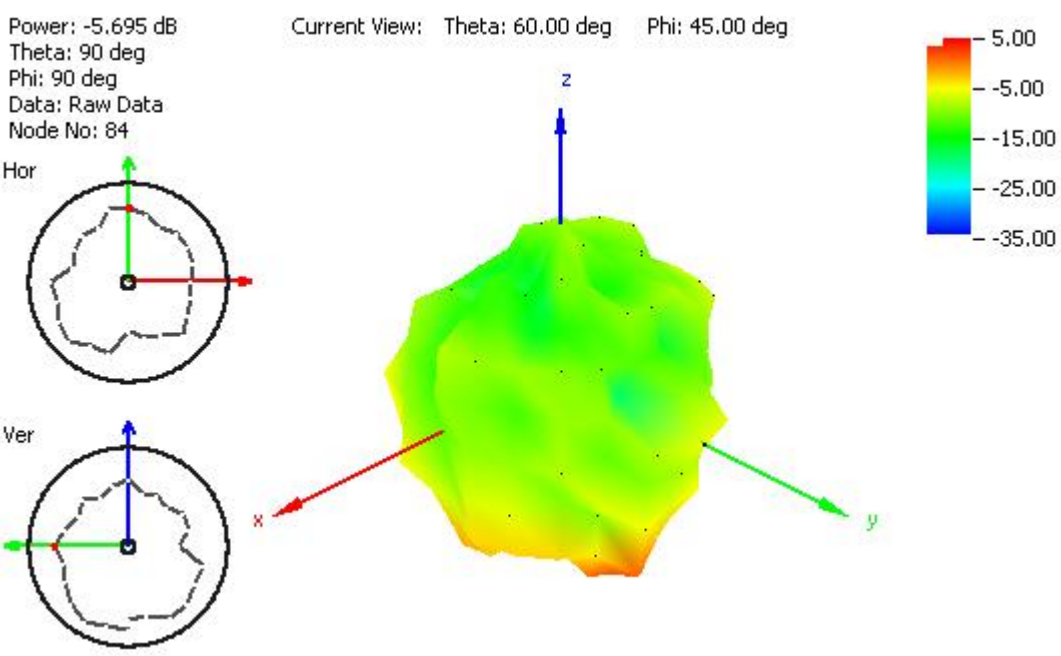

Figure 24. Radiation pattern at 1910 MHz, Figure 1 as reference (dB), with 2 m RG174 cable and 60x60 cm metal plate.

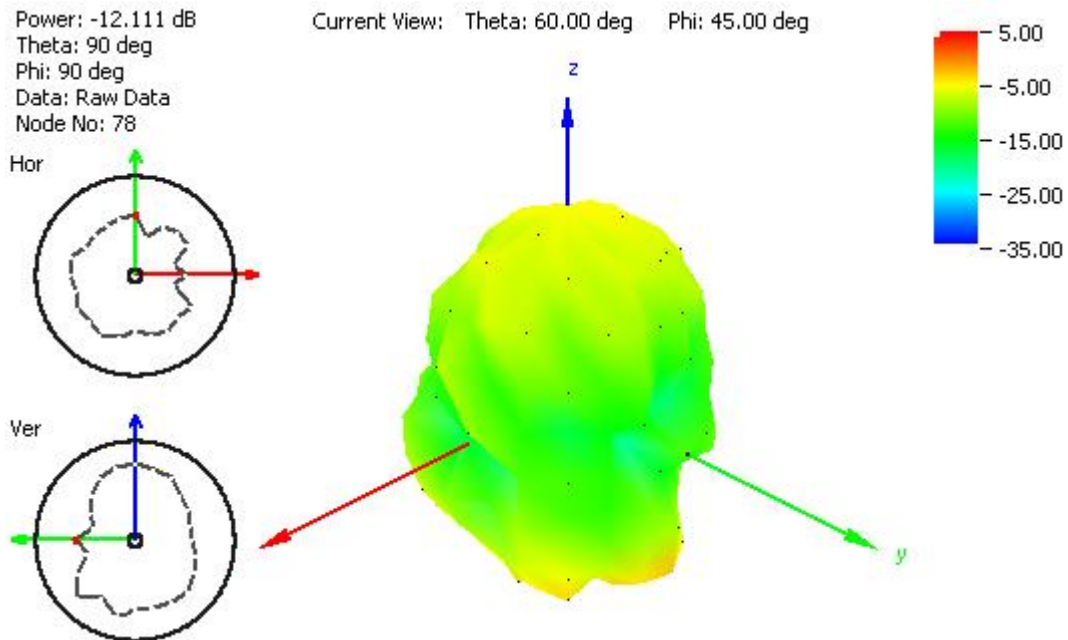
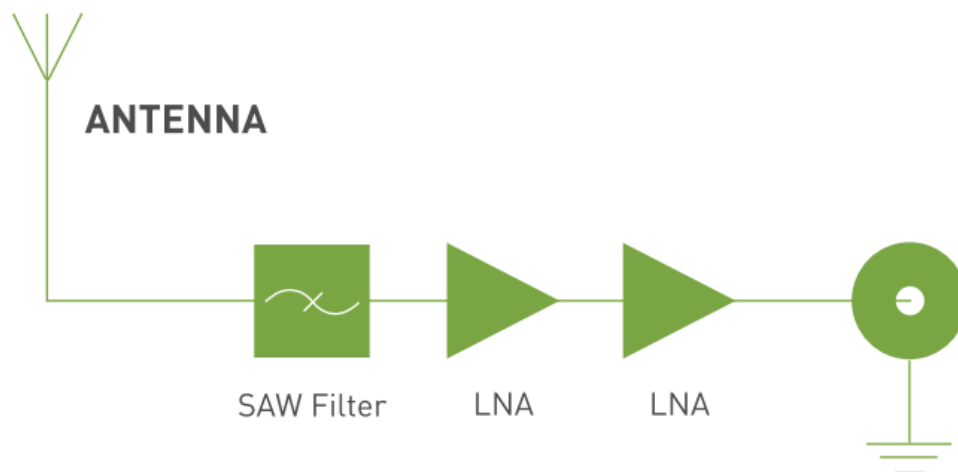

Figure 25. Radiation pattern at 2110 MHz, Figure 1 as reference (dB), with 2 m RG174 cable and 60x60 cm metal plate.

5. System Block Diagram



6. GPS-GLONASS-GALILEO Passive Antenna Results

6.1 Return Loss

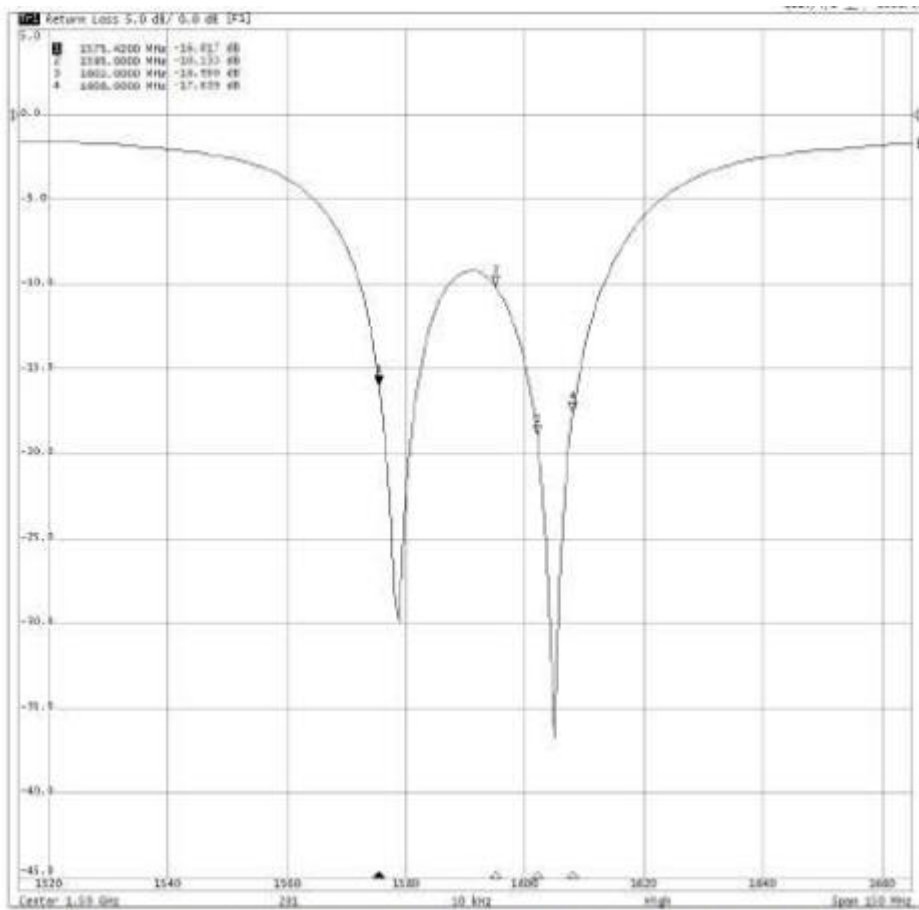

1575.42 MHz - 16.01 dB
 1602.60 MHz - 18.95 dB

6.2 VSWR

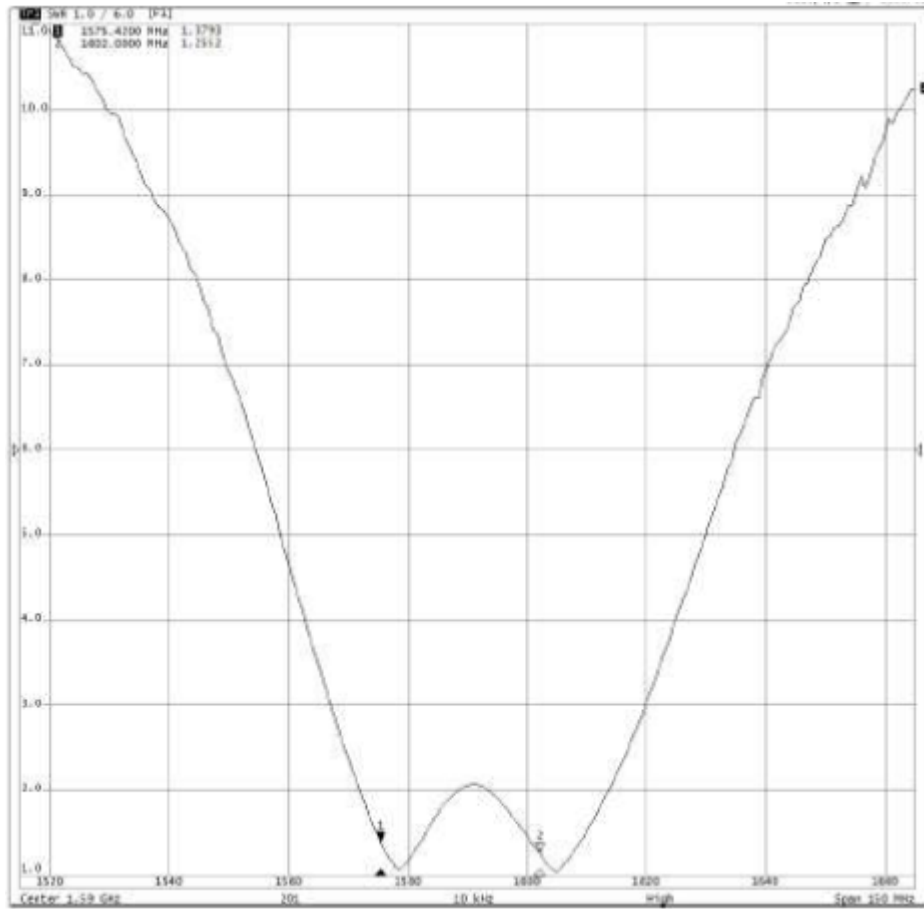

1.37 @ 1575.42MHz
 1.25 @ 1602.60MHz

6.3 Smith Chart

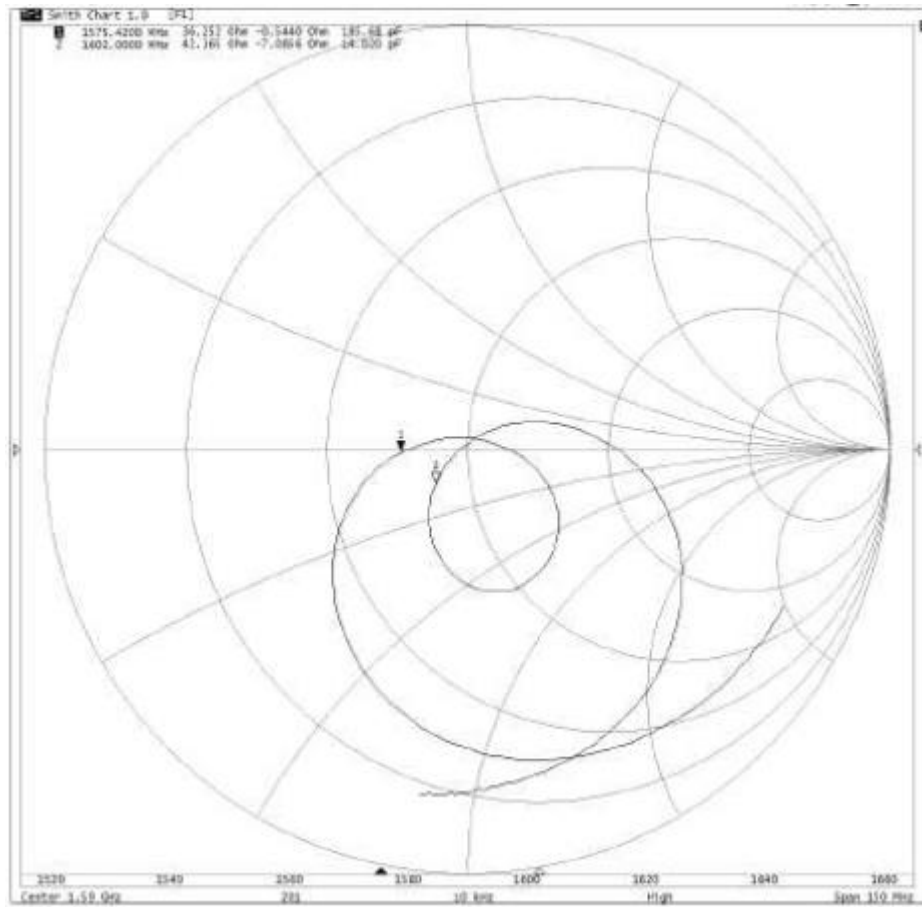

36.52-j0.54 Ohm
 42.36-j7.08 Ohm

6.4 Radiation Patterns

6.4.1 1575.42 MHz XZ-Plane

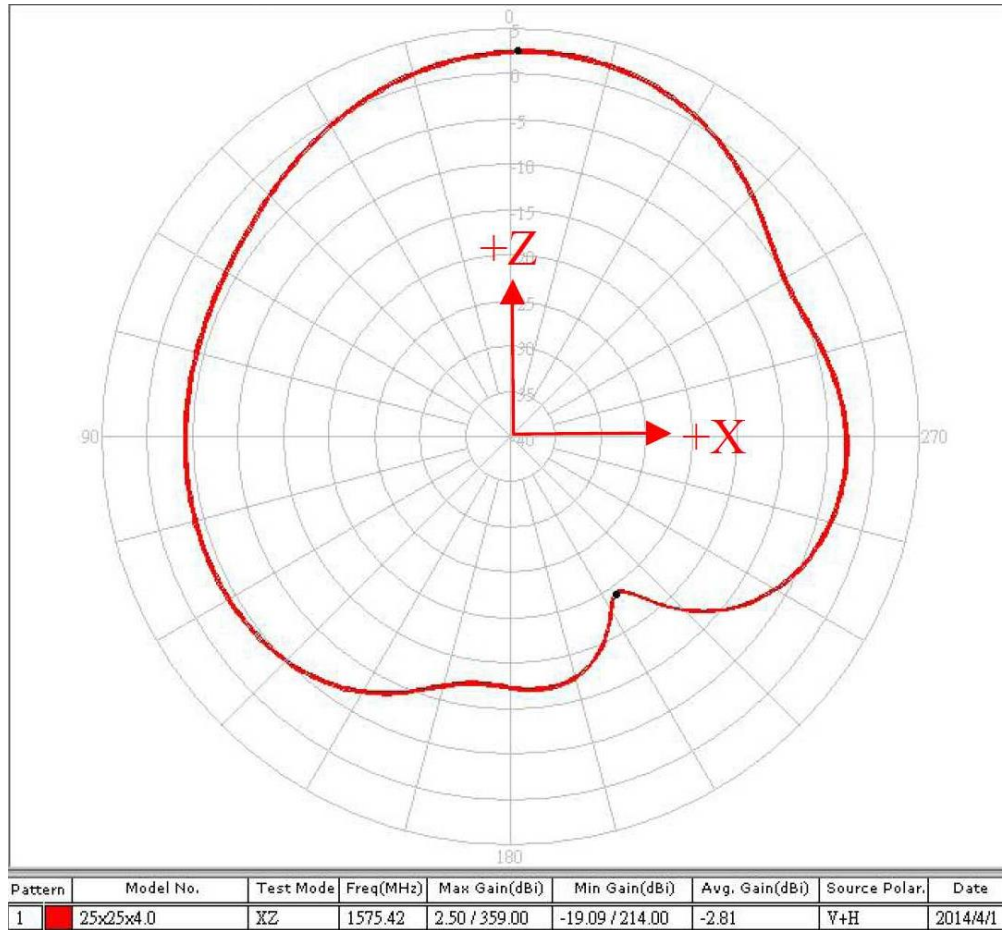

6.4.2 1575.42 MHz YZ-Plane

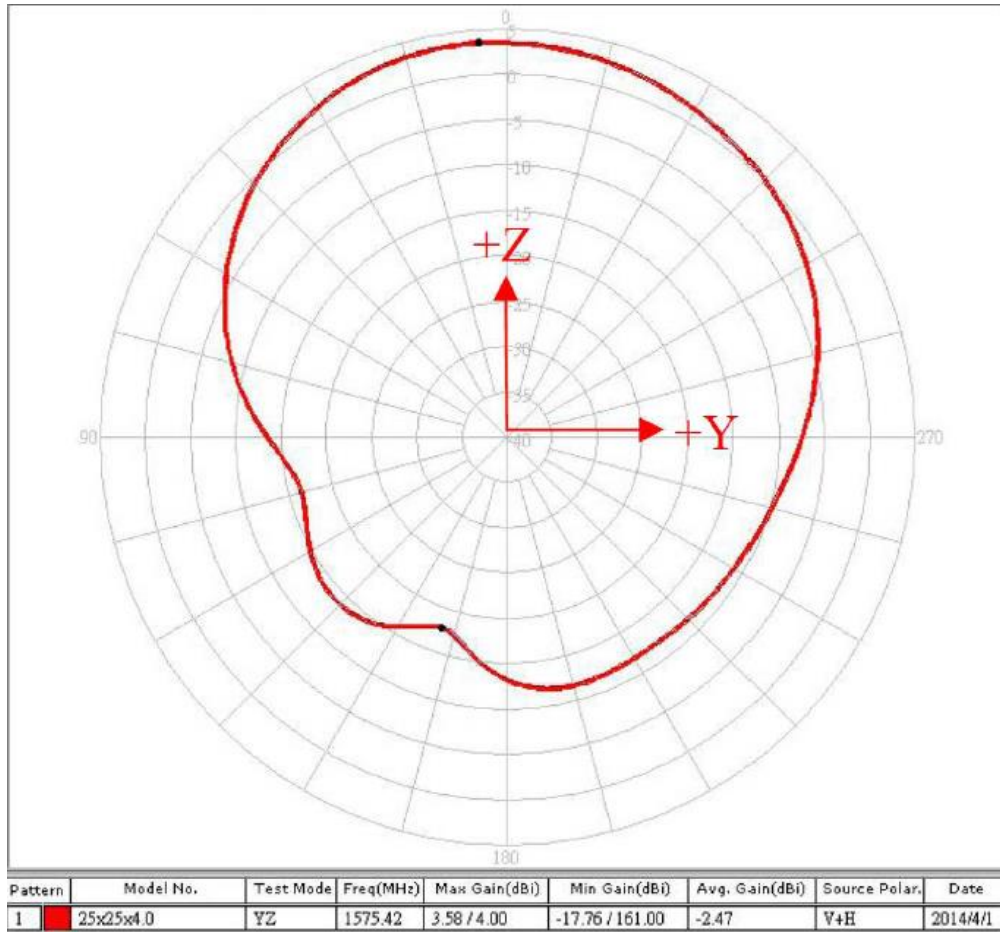

6.4.3 1602 MHz XZ-Plane

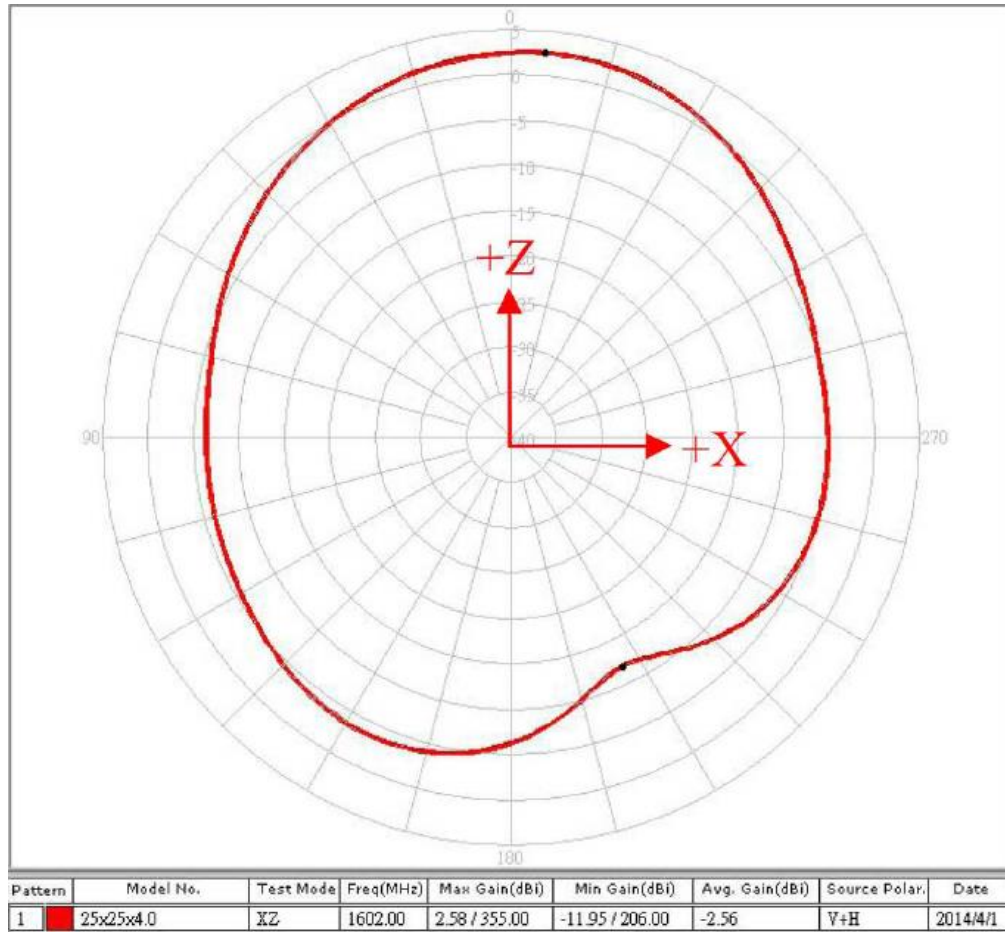

6.4.4 1602 MHz YZ-Plane

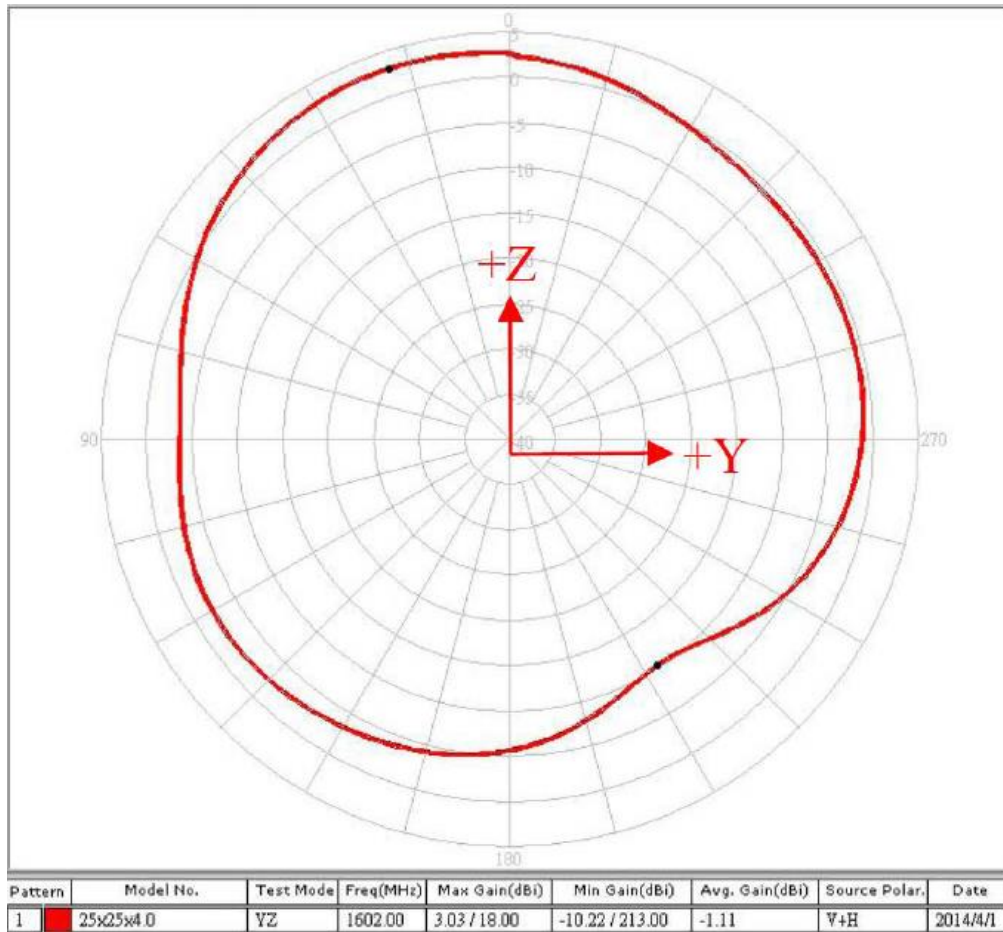

7. GPS/GALILEO – Low Noise Amplifier

7.1 Gain and Out Band Rejection@3.0V

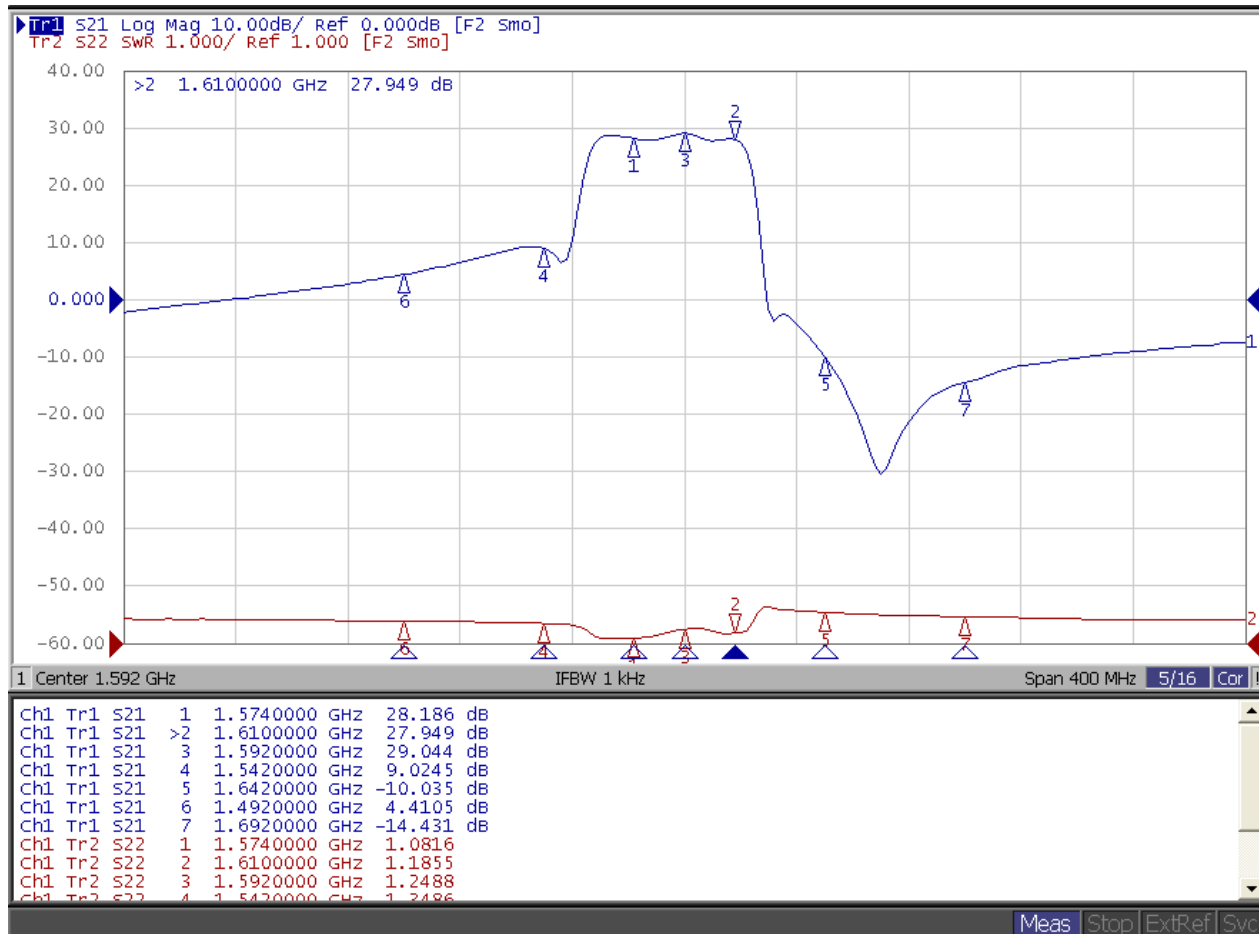

7.2 Noise Figure@3.0V

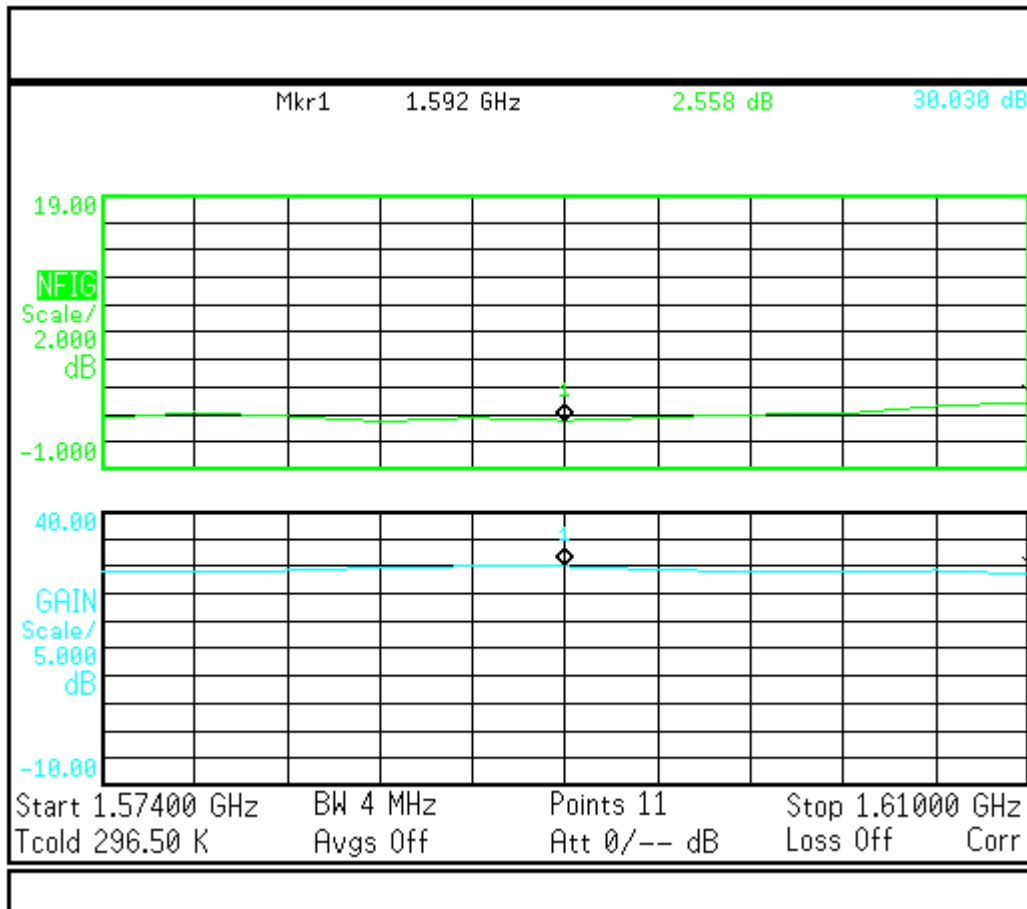

8. Drawing (Unit mm)

	Name	Material	Finish	QTY
1	Housing	PC	Black	1
2	Closed Cell Foam	CR 4305	Black	1
3	3M Double Adhesive	3M 9448 HK	White Liner	1
4	M18 Inner Nut	Carbon Steel	Ni Plated	1
5	Outer Nut Cover	ABS	Black	1
6	Metal Base	Zinc alloy	Ni Plated	1
7	Rubber Stopper	Rubber	Black	1
8	GPS-Glonass Label	Coated Paper	Orange	1
9	Cellular Label	Coated Paper	Blue	1
10	Heat Shrink Tube	PE	Black	1
11	Heat Shrink Tube	PE	Black	1

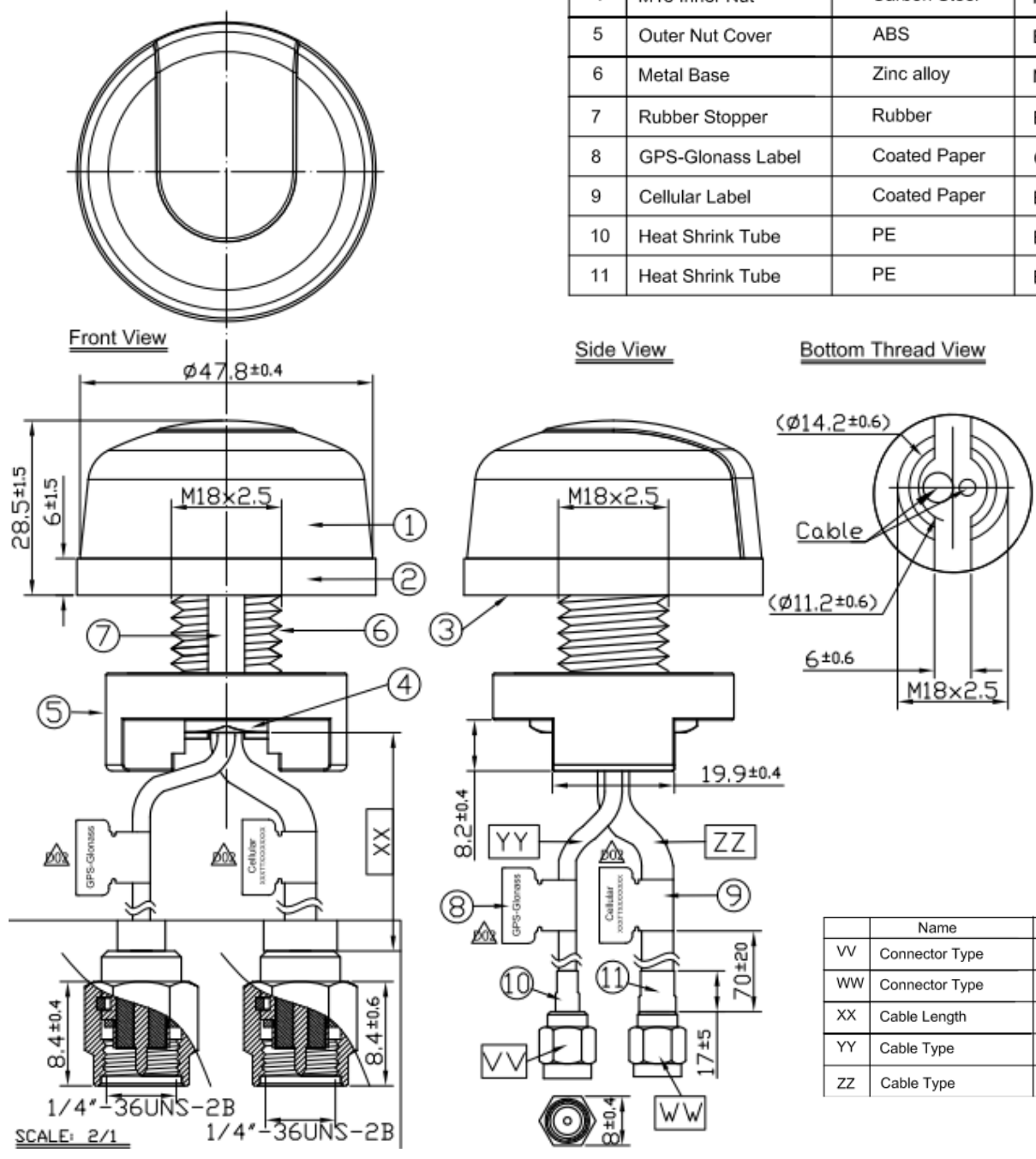

Name	Spec
VV	Connector Type SMA(M) ST
WW	Connector Type SMA(M) ST
XX	Cable Length 3000±50 mm
YY	Cable Type RG174
ZZ	Cable Type CFD 200

9. Packaging

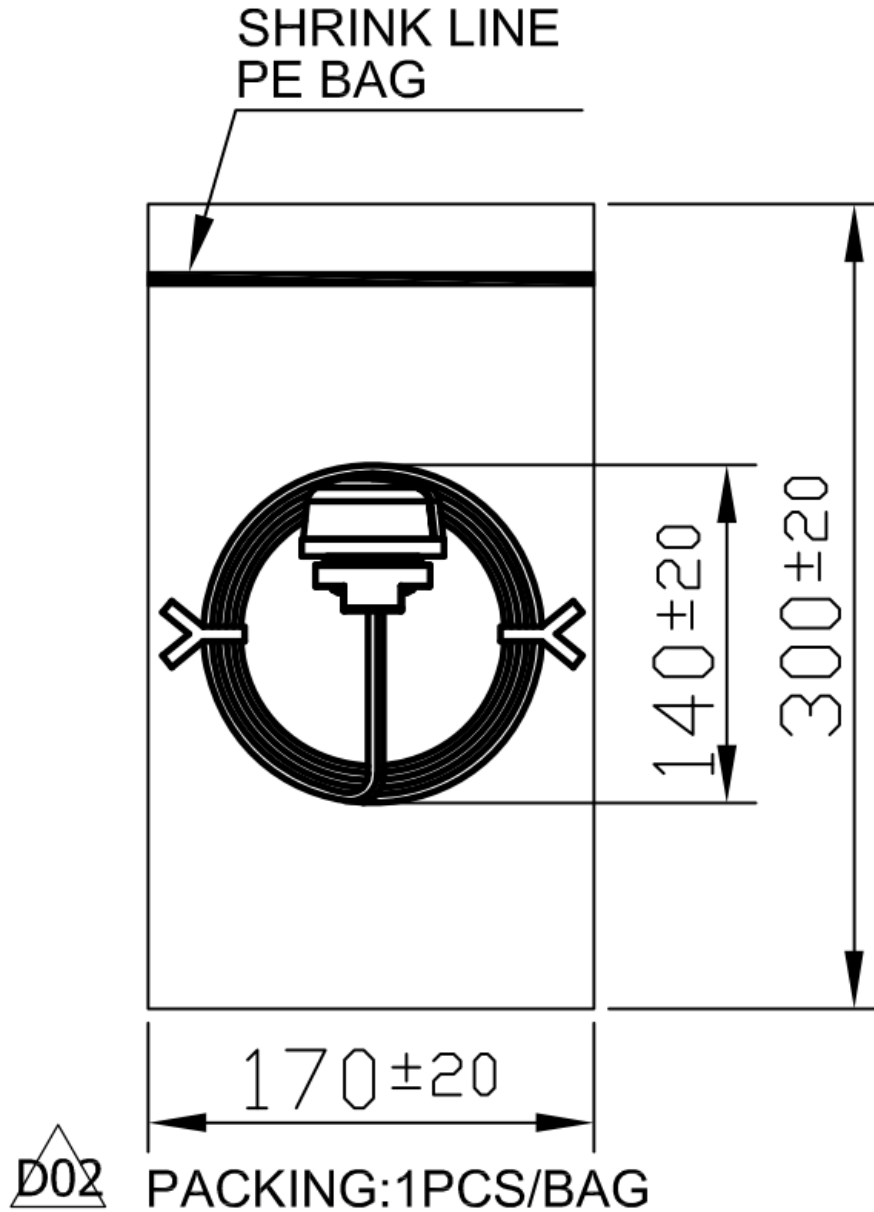

10. Installation

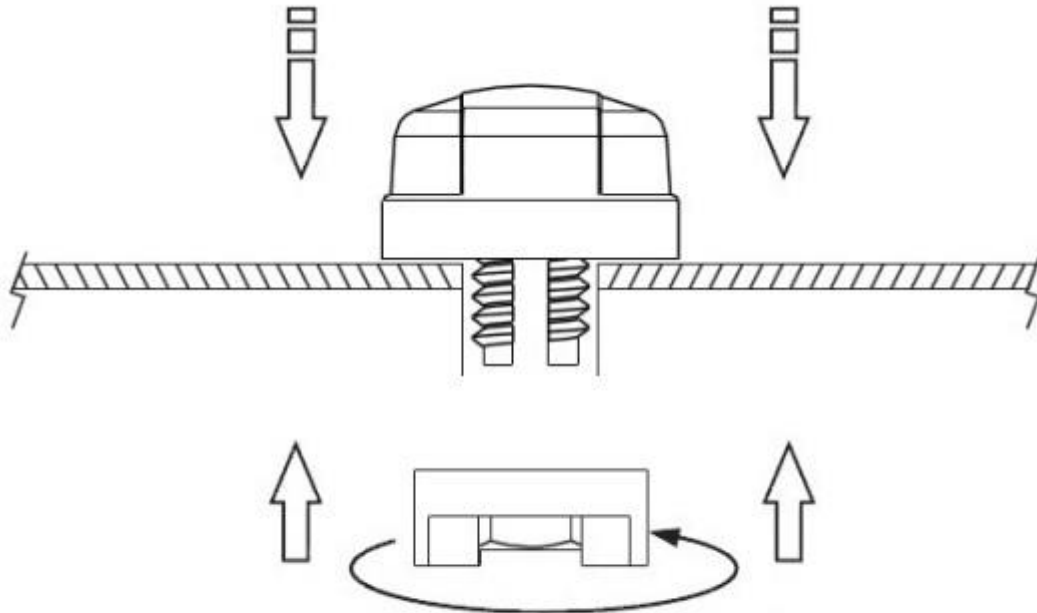

Recommended torque for Mounting is $24.5\text{N}\cdot\text{m}$
Maximum torque for mounting is $29.4\text{N}\cdot\text{m}$

Taoglas makes no warranties based on the accuracy or completeness of the contents of this document and reserves the right to make changes to specifications and product descriptions at any time without notice. Taoglas reserves all rights to this document and the information contained herein.

Reproduction, use or disclosure to third parties without express permission is strictly prohibited.

Copyright © Taoglas Ltd.

