



SERIES: SWI12-N | **DESCRIPTION:** AC-DC POWER SUPPLY

FEATURES

- DoE Leve VI efficiency
- up to 12 W power
- universal input (90~264 Vac)
- single regulated output from 5~24 Vdc
- over voltage, over current, and short circuit protections
- UL/cUL, PSE safety approvals
- custom designs available



MODEL	output voltage (Vdc)	output current max (A)	output power max (W)	ripple and noise ¹ max (mVp-p)	efficiency level
SWI12-5-N	5	2.5	12.5	100	VI
SWI12-5.9-N	5.9	2.0	11.8	100	VI
SWI12-9-N	9	1.2	10.8	100	VI
SWI12-12-N	12	1.0	12	120	VI
SWI12-24-N	24	0.5	12	240	VI

Notes: 1. At full load, nominal input, 20 MHz bandwidth oscilloscope, each output terminated with 0.1 µF multilayer ceramic and 47 µF low ESR electrolytic capacitors.

PART NUMBER KEY

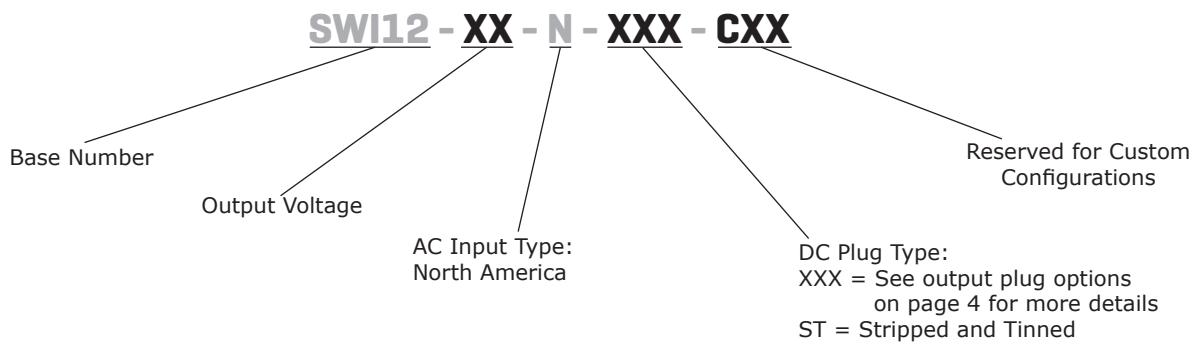

INPUT

parameter	conditions/description	min	typ	max	units
voltage		90		264	Vac
frequency		47		63	Hz
current				0.31	A
inrush current	at 240 Vac, full load, 25°C, cold start			60	A
leakage current				0.25	mA
no load power consumption	at 115/230 Vac			0.075	W

OUTPUT

parameter	conditions/description	min	typ	max	units
regulation			±5		%

PROTECTIONS

parameter	conditions/description	min	typ	max	units
over voltage protection	output shut down			180	%
over current protection	output shut down, auto recovery				
	5 Vdc model			5.0	A
	5.9 Vdc model			4.5	A
	9 Vdc model			3.0	A
	12 Vdc model			3.0	A
short circuit protection	24 Vdc model			1.5	A
	output shut down, auto recovery				

SAFETY & COMPLIANCE

parameter	conditions/description	min	typ	max	units
isolation voltage	input to output at 10 mA for 1 minute		3,000		Vac
isolation resistance	input to output at 500 Vdc	10			MΩ
safety approvals	UL/cUL, LPS, PSE				
EMI/EMC	FCC Part 15B Class B				
MTBF	as per Telcordia SR-332, at 25°C	300,000			hours
RoHS	2011/65/EU				

ENVIRONMENTAL

parameter	conditions/description	min	typ	max	units
operating temperature		0		40	°C
storage temperature		-20		80	°C
operating humidity	non-condensing	20		80	%
storage humidity	non-condensing	10		90	%

MECHANICAL

parameter	conditions/description	min	typ	max	units
dimensions	72 x 34 x 59				mm
inlet plug	North America, 2-pin				
weight			126		g

MECHANICAL DRAWING

units: mm

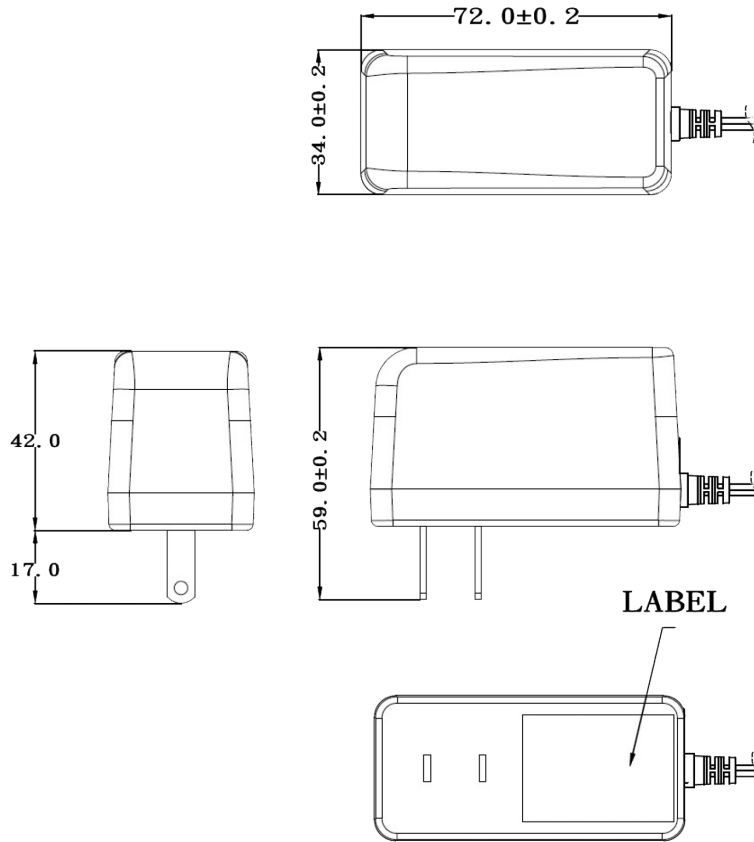

DC CORD

units: mm

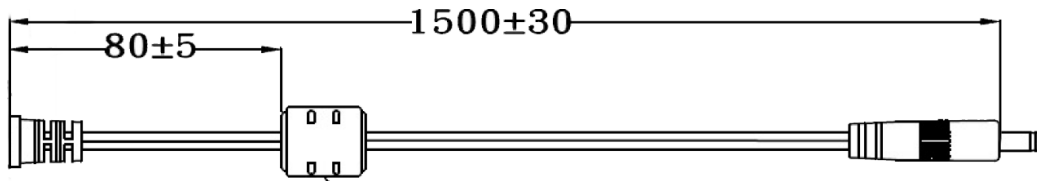

DC cord circled one time to core

Table 1

MODEL NO.	CABLE	CORD LENGTH
SWI12-5-N	UL2468, 18 AWG	1,500 mm ±30
SWI12-5.9-N	UL2468, 20 AWG	1,500 mm ±30
SWI12-9-N	UL2468, 20 AWG	1,500 mm ±30
SWI12-12-N	UL2468, 22 AWG	1,500 mm ±30
SWI12-24-N	UL2468, 22 AWG	1,500 mm ±30

OUTPUT PLUG OPTIONS

Standard DC Plug

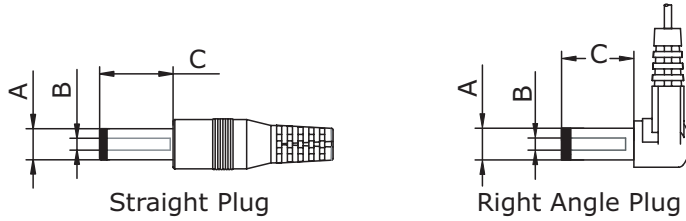

Size	A	B	C	Unit
5	5.5	2.1	9.5	mm
6	5.5	2.5	9.5	mm
7	3.5	1.35	9.5	mm
8	3.8	1.35	9.5	mm
9	3.8	1.05	9.5	mm

Locking DC Plug



Size	A	B	C	Unit
10	5.5	2.1	9.5	mm
11	5.5	2.5	9.5	mm

EIAJ DC Plug

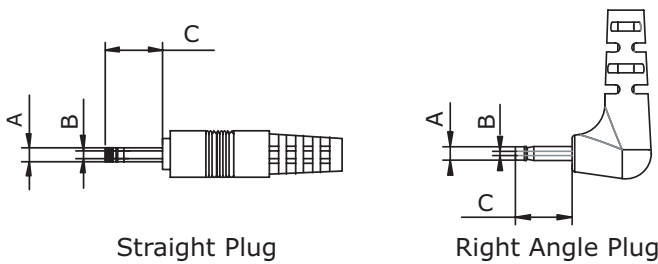

Size	EIAJ	A	B	C	Unit
12	EIAJ-1	2.35	0.7	9.5	mm
13	EIAJ-2	4.0	1.7	9.5	mm
14	EIAJ-3	4.75	1.7	9.5	mm

Stripped and Tinned

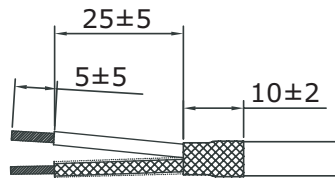

DC Plug Type

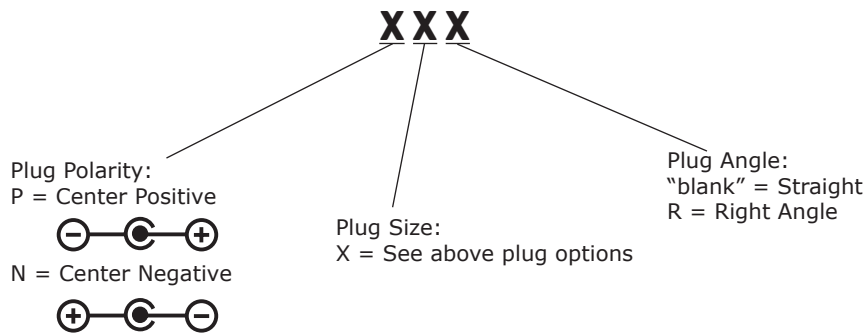

*Contact CUI for additional plug options

REVISION HISTORY

rev.	description	date
1.0	initial release	04/30/2015
1.01	updated datasheet	06/12/2015

The revision history provided is for informational purposes only and is believed to be accurate.



CUI INC[®]

Headquarters
20050 SW 112th Ave.
Tualatin, OR 97062
800.275.4899

Fax 503.612.2383
cui.com
techsupport@cui.com

This device complies with part 15 of the FCC Rules. Operation is subject to the following two conditions:

- (1) This device may not cause harmful interference, and
- (2) this device must accept any interference received, including interference that may cause undesired operation.

CUI offers a one (1) year limited warranty. Complete warranty information is listed on our website.

CUI reserves the right to make changes to the product at any time without notice. Information provided by CUI is believed to be accurate and reliable. However, no responsibility is assumed by CUI for its use, nor for any infringements of patents or other rights of third parties which may result from its use.

CUI products are not authorized or warranted for use as critical components in equipment that requires an extremely high level of reliability. A critical component is any component of a life support device or system whose failure to perform can be reasonably expected to cause the failure of the life support device or system, or to affect its safety or effectiveness.