



Technical Data Sheet

Light Emitting Diode (5 mm Round LED,T-1 3/4)

7343-2SURC/S400-AX

Features

- Popular T-1 3/4 diameter package.
- Choice of various viewing angles.
- Reliable and robust.
- Pb free
- The product itself will remain within RoHS compliant version.



Descriptions

- The series is specially designed for applications requiring higher brightness.
- The LED lamps are available with different colors,intensities,epoxy colors, etc.

Applications

- TV set.
- Monitor.
- Telephone.
- Computer.

Device Selection Guide

| Chip | | Lens Color |
|----------|---------------|-------------|
| Material | Emitted Color | |
| AlGaInP | Hyper Red | Water Clear |

Technical Data Sheet

Light Emitting Diode (5 mm Round LED,T-1 3/4)

7343-2SURC/S400-AX

Package Dimensions

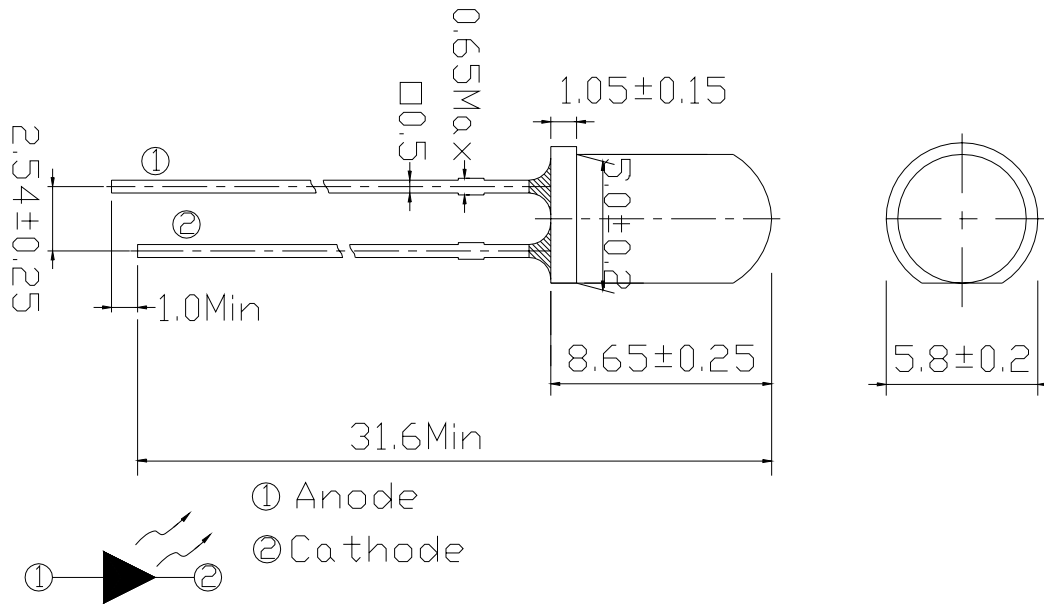

Notes:

- All dimensions are in millimeters , tolerance is 0.25mm except being specified.
- Lead spacing is measured where the lead emerges from the package.
- Protruded resin under flange is 1.5mm Max LED.

Absolute Maximum Ratings (Ta=25°C)

| Parameter | Symbol | Rating | Units |
|-------------------------------------|------------------|------------|-------|
| Forward Current | I _F | 50 | mA |
| Pulse Forward Current ^{*1} | I _{FP} | 200 | mA |
| Operating Temperature | T _{opr} | -40 ~ +85 | °C |
| Storage Temperature | T _{stg} | -40 ~ +100 | °C |
| Electrostatic Discharge | ESD | 2000 | V |
| Soldering Temperature ^{*2} | T _{sol} | 260 ±5 | °C |
| Power Dissipation | P _d | 120 | mW |
| Reverse Voltage | V _R | 5 | V |

Notes: *1:I_{FP} Conditions--Pulse Width ≤ 10msec and Duty ≤ 1/10.

*2:Soldering time ≤ 5 seconds.



Technical Data Sheet

Light Emitting Diode (5 mm Round LED,T-1 3/4)

7343-2SURC/S400-AX

Electro-Optical Characteristics (Ta=25°C)

| Parameter | Symbol | Condition | Chip Rank | Min. | Typ. | Max. | Units |
|------------------------------|----------------|----------------------|-----------|------|------|------|-------|
| Forward Voltage | V _F | I _F =20mA | -- | -- | 2.0 | 2.4 | V |
| Reverse Current | I _R | V _R =5V | -- | -- | -- | 10 | μA |
| Luminous Intensity | I _v | I _F =20mA | A6 | 1000 | 1600 | -- | mcd |
| | | | A7 | 1250 | 2000 | -- | |
| | | | A8 | 1600 | 2500 | -- | |
| Viewing Angle | 2θ 1/2 | I _F =20mA | -- | -- | 25 | -- | deg |
| Peak Wavelength | λ _p | I _F =20mA | -- | -- | 632 | -- | nm |
| Dominant Wavelength | λ _d | I _F =20mA | -- | -- | 624 | -- | nm |
| Spectrum Radiation Bandwidth | Δλ | I _F =20mA | -- | -- | 20 | -- | nm |

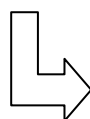
***7343-2SURC/S400-AX**

Chip Rank

Typical Electro-Optical Characteristics Curves

Technical Data Sheet

Light Emitting Diode (5 mm Round LED,T-1 3/4)

7343-2SURC/S400-AX

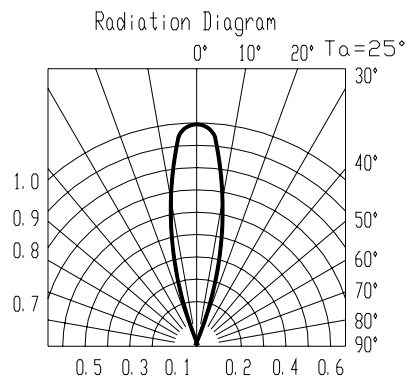
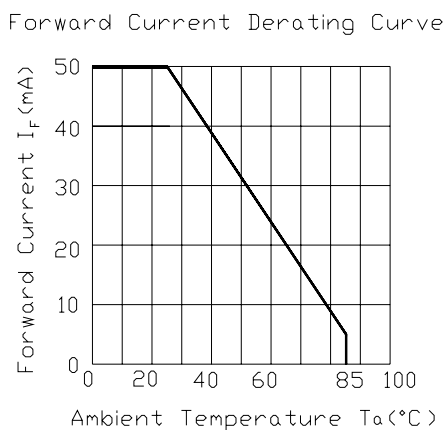
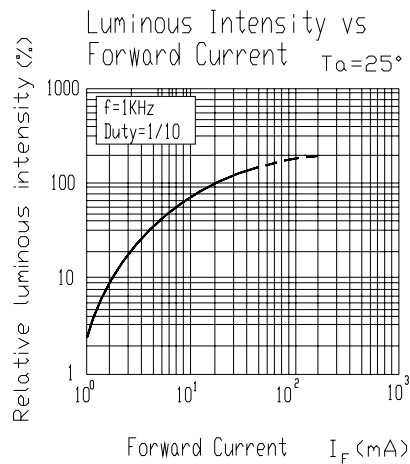
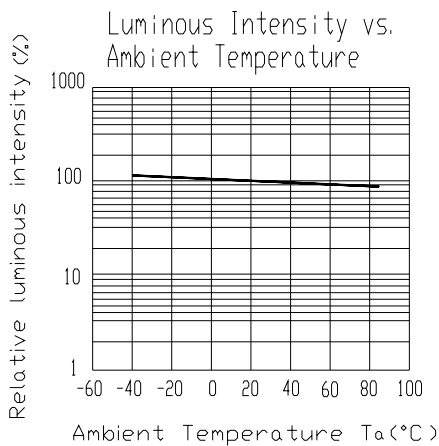
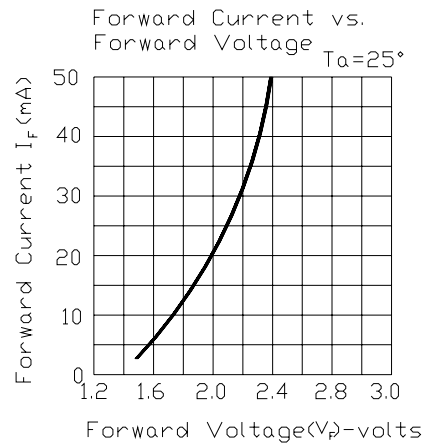
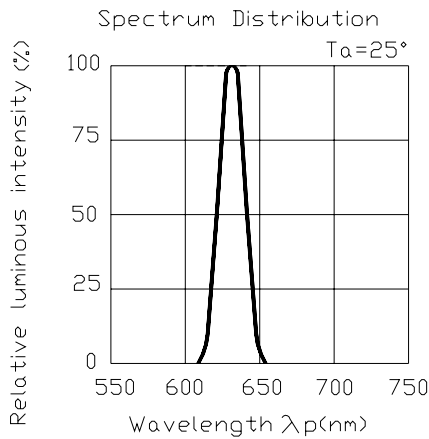

Packing Quantity Specification



Technical Data Sheet



Light Emitting Diode (5 mm Round LED,T-1 3/4)

7343-2SURC/S400-AX

1.500PCS/1Bag , 5Bags/1Box

2.10Boxes/1Carton

Label Form Specification

| | |
|---|---|
| EVERLIGHT | |
| CPN: | |
| P/N: |  RoHS |
| 7343-2SURC/S400-AX | |
| QTY : | CAT: |
|  | HUE: |
| LOT NO : | REF: |
|  | |
| MADE IN TAIWAN | |

CPN: Customer's Production Number

P/N : Production Number

QTY: Packing Quantity

AT: Ranks

HUE: Peak Wavelength

REF: Reference

LOT No: Lot Number

MADE IN TAIWAN: Production Place

Notes

1. Above specification may be changed without notice. EVERLIGHT will reserve authority on material change for above specification.
2. When using this product, please observe the absolute maximum ratings and the instructions for using outlined in these specification sheets. EVERLIGHT assumes no responsibility for any damage resulting from use of the product which does not comply with the absolute maximum ratings and the instructions included in these specification sheets.
3. These specification sheets include materials protected under copyright of EVERLIGHT corporation. Please don't reproduce or cause anyone to reproduce them without EVERLIGHT's consent.

EVERLIGHT ELECTRONICS CO., LTD.
 Office: No 25, Lane 76, Sec 3, Chung Yang Rd,
 Tucheng, Taipei 236, Taiwan, R.O.C

Tel: 886-2-2267-2000, 2267-9936
 Fax: 886-2267-6244, 2267-6189, 2267-6306
<http://www.everlight.com>