



SAMSUNG
ARTIK[™] Modules

O

**ARTIK 055s Development Kit
Hardware User's Guide**

Version History 2

ARTIK 055s Development Kit Contents 3

ARTIK 055s Additional Documentation 3

Additional Materials 3

ARTIK 055s Development Kit Overview 4

 ARTIK 055s Main Components 4

 ARTIK 055s Development Kit Block Diagram 5

ARTIK 055s Development Kit Interposer Board 6

 ARTIK 055s Module 6

 ARTIK 055s Interposer Board Connectors 6

ARTIK 055s Starter Board 8

 Starter Board Interfaces 8

 Power Interface 8

 micro-USB Interface 9

 JTAG Interface 9

 Pushbutton Switches 10

 LED Interface 11

 ARTIK 055s Starter Board Connectors 12

 Arduino Connectors 12

 Break-out Connectors 13

 Starter Board to Interposer Board Interface Connectors 13

Mechanical Specifications 14

 Starter Board Dimensions 14

 ARTIK 055s Interposer Board and Module Dimensions 15

Figure 1. ARTIK 055s Development Kit Interposer and Starter Boards4

Figure 2. ARTIK 055s Development Platform System Block Diagram5

Figure 3. ARTIK 055s Interposer Board Connectors6

Figure 4. Location of Power Connectors on the Starter Board9

Figure 5. JTAG Connector Location on Starter Board9

Figure 6. Location of Push Button Switches on the Starter Board10

Figure 7. Location of Push Button Switches on the Starter Board11

Figure 8. Location of Starter Board Interface Connectors12

Figure 9. ARTIK 055s Starter Board Mechanical Specifications.....14

Figure 10. ARTIK 055s Interposer Board and Module Mechanical Specifications.....15

VERSION HISTORY

Revision	Date	Description
V1.0	November 30, 2017	Initial draft of ARTIK 055s Development Kit Hardware User's Guide.

This document describes the ARTIK 055s Development Kit.

ARTIK 055s DEVELOPMENT KIT CONTENTS

The ARTIK 055s development kit consists of the following components:

- ARTIK 055s Interposer board (contains ARTIK 055s module)
- ARTIK 055s Starter board (connected to the Interposer board at the factory)

Each of these components is described in the following subsections.

ARTIK 055s ADDITIONAL DOCUMENTATION

The following documents provide additional information on the ARTIK 710 development environment.

- ARTIK 055s Data Sheet
- ARTIK 053s/055s System Design Guide
- ARTIK PCB Design Guide
- ARTIK 055s Interposer board schematics
- ARTIK 055s Starter board schematics
- ARTIK 055s Bill of Materials

ADDITIONAL MATERIALS

Depending on the system environment, the following components may be required when interfacing to the ARTIK 055s Development Platform.

- 3.3V DC, 24W power supply for connecting to the DC power jack on the Starter board.
- micro-USB cable for connecting an external host or when transferring data over the USB port.

ARTIK 055s DEVELOPMENT KIT OVERVIEW

The ARTIK 055s Development kit consists of one Interposer Board and one Starter Board. The Interposer board includes the ARTIK 055s module which is soldered to the board at the factory.

The Samsung ARTIK™ 055s Development Kit provides a development platform for the 055s module.

For more information about the ARTIK 055s Module, see the “ARTIK 055s Datasheet”.

ARTIK 055s Main Components

Figure 1 shows the two boards that make up the ARTIK 055s Development Kit.

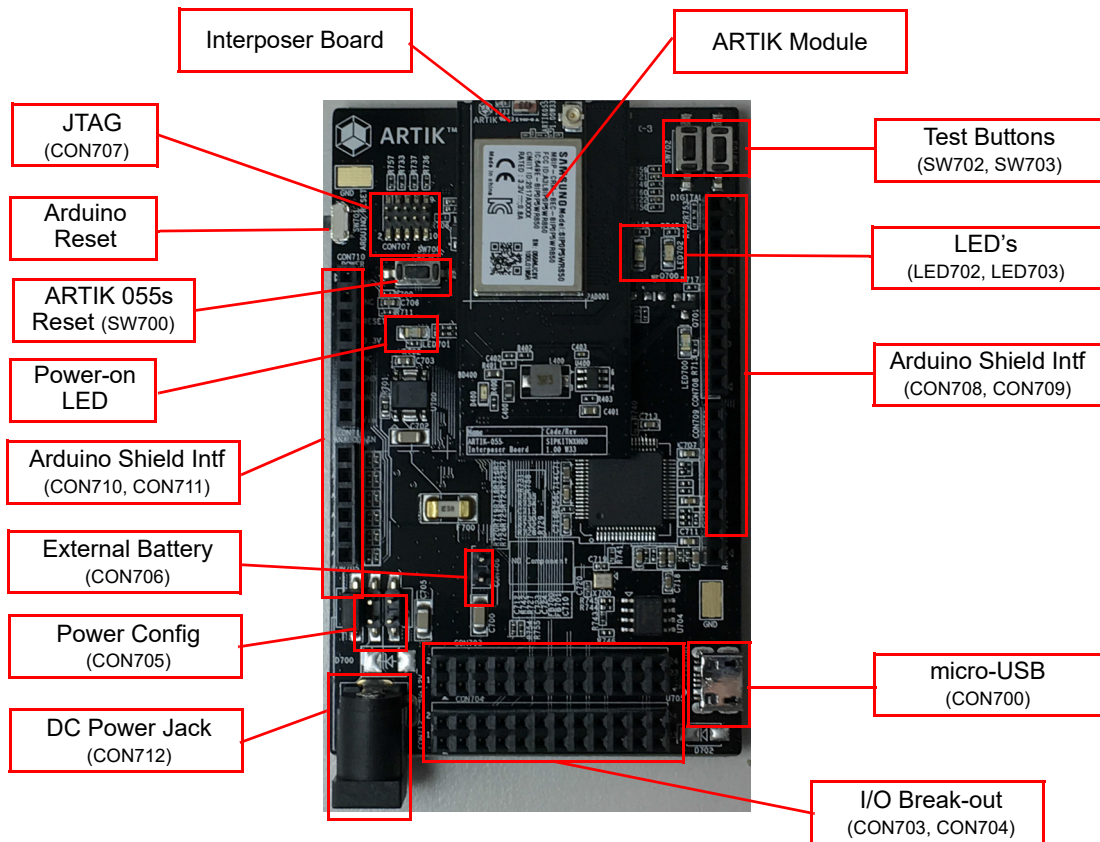

Figure 1. ARTIK 055s Development Kit Interposer and Starter Boards

ARTIK 055s Development Kit Block Diagram

Figure 2 shows a system block diagram of the two boards in the ARTIK 055s development kit and the relative location of each interface.

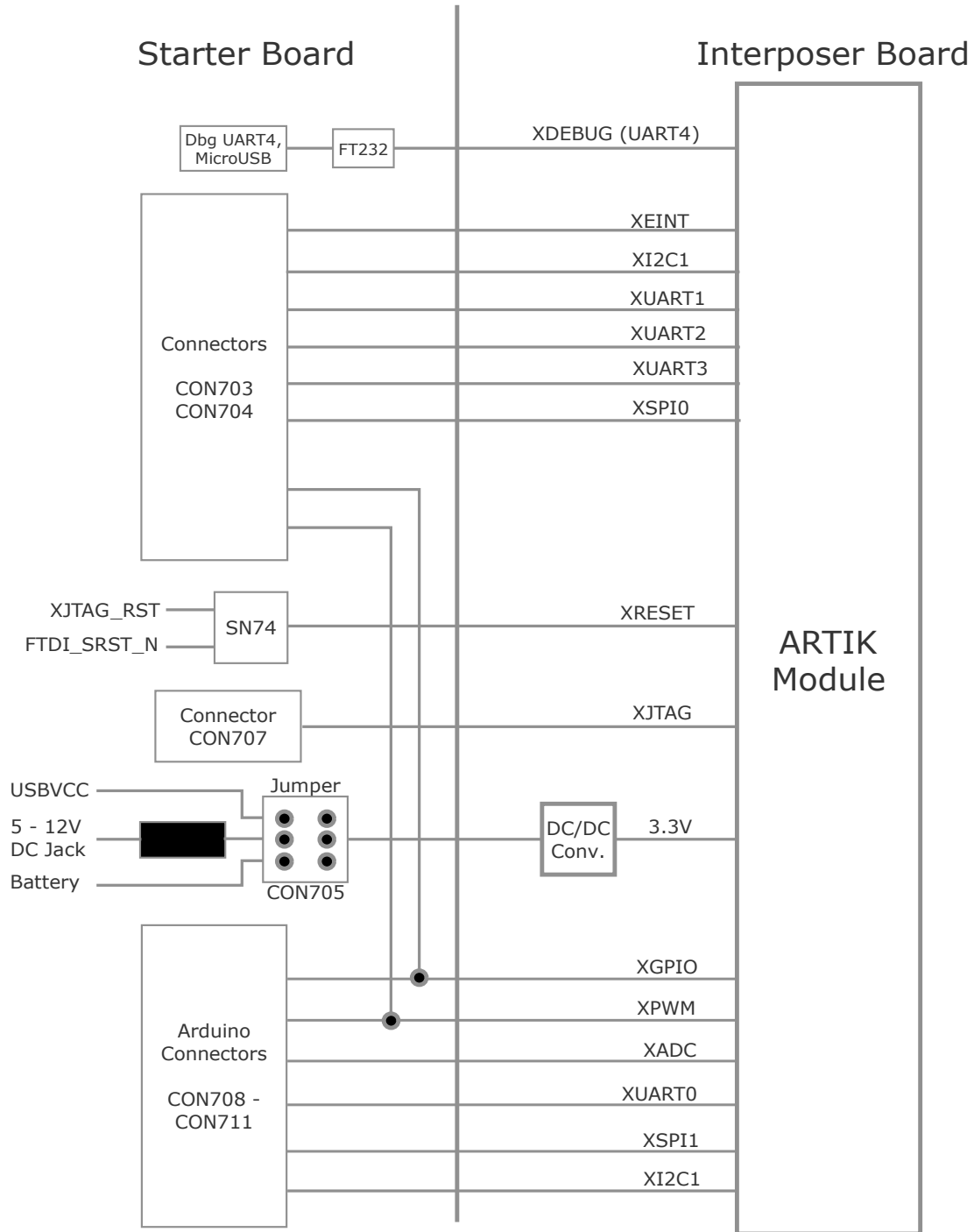

Figure 2. ARTIK 055s Development Platform System Block Diagram

ARTIK 055s DEVELOPMENT KIT INTERPOSER BOARD

This section describes the various components and interfaces on the Interposer board.

ARTIK 055s Module

The ARTIK 055s Development Kit contains the ARTIK 055s module that is soldered to the Interposer board. [Table 1](#) shows the main features of the ARTIK 055s module.

Table 1. ARTIK 055s Module Main Features

Feature	Description
CPU	32-bit ARM Cortex R4 with 32 KB I-Cache and 32 KB D-Cache @ 320 MHz
DRAM	1280 KB (General Usage), 128 KB (Global IPC data)
Flash	8 MB
Secure Element	AES/DES/TDES, SHA-1/SHA-2, PKA (Public Key Accelerator) PRNG/DTRNG (Pseudo-random Number Generators), Secure Key Storage
	Physically Unclonable Function (PUF)
WiFi	Certified IEEE802.11™ b/g/n Wi-Fi® 2.4GHz radio served by a dedicated 32-bit ARM Cortex R4 with 32KB I-Cache and 16KB D-Cache @ 480MHz
Regulatory	FCC (U.S.), IC (Canada), CE (EU), KC (Korea), SRRC (China)
Power Management	3.3V supply
Analog and Digital I/O	GPIO, UART, I2C, SPI, ADC, PWM, I2S
Dimensions	15 mm x 26 mm x 3.9 mm

ARTIK 055s Interposer Board Connectors

The Interposer Board is the bridge between the Starter Board and the ARTIK 055s Module. The CON400 and CON401 connectors on the Interposer Board plug into the CON701 and CON702 connectors on the Starter Board. The connectors are on the bottom of the Interposer board as shown in [Figure 3](#).

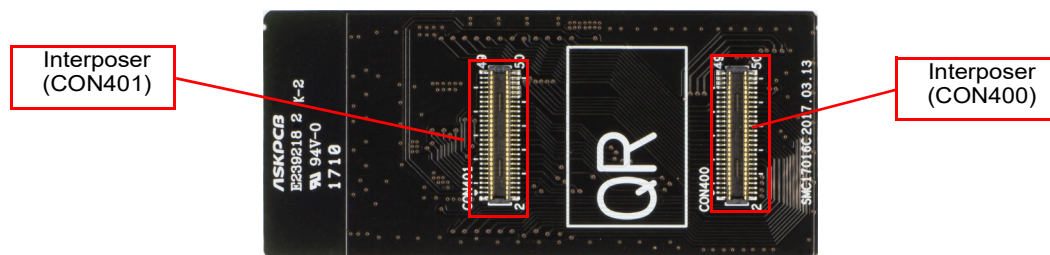

Figure 3. ARTIK 055s Interposer Board Connectors

Table 2. ARTIK 055s Interposer Board CON400 Connector Pinout and ARTIK Module Pin Mapping

ARTIK Module		Connector CON400				ARTIK Module	
Pin Name	Pin Number	Pin Name	Pin Number	Pin Number	Pin Name	Pin Number	Pin Name
XGPIO26	2	XGPIO26	1	2	XSPI1_CSN	74	XSPI1_CSN
XGPIO25	3	XGPIO25	3	4	XSPI1_MOSI	73	XSPI1_MOSI
XGPIO24	4	XGPIO24	5	6	XSPI1_CLK	72	XSPI1_CLK
XGPIO21	5	XGPIO21	7	8	XSPI1_MISO	71	XSPI1_MISO
XGPIO19	6	XGPIO19	9	10	GND	N/A	N/A
XGPIO18	7	XGPIO18	11	12	N/C	N/A	N/A
XGPIO17	8	XGPIO17	13	14	XGPIO3	69	XGPIO3
XGPIO14	9	XGPIO14	15	16	XGPIO1	68	XGPIO1
XGPIO13	10	XGPIO13	17	18	GND	N/A	N/A
XGPIO16	11	XGPIO16	19	20	XGPIO5	67	XGPIO5
XGPIO15	12	XGPIO15	21	22	XGPIO4	66	XGPIO4
XGPIO20	13	XGPIO20	23	24	XGPIO2	65	XGPIO2
N/A	N/A	GND	25	26	XGPIO7	64	XGPIO7
XADCOAIN_0	15	XADCOAIN_0	27	28	XGPIO8	63	XGPIO8
XADCOAIN_1	14	XADCOAIN_1	29	30	XGPIO6	62	XGPIO6
XADCOAIN_2	16	XADCOAIN_2	31	32	GND	N/A	N/A
XADCOAIN_3	17	XADCOAIN_3	33	34	XGPIO11	61	XGPIO11
N/A	N/A	GND	35	36	XGPIO9	60	XGPIO9
XGPIO23	18	XGPIO27	37	38	XGPIO10	59	XGPIO10
XGPIO22	19	XGPIO22	39	40	XGPIO12	58	XGPIO12
N/A	N/A	N/C	41	42	GND	N/A	N/A
N/A	N/A	N/C	43	44	XUART3_TXD	57	XUART3_TXD
N/A	N/A	GND	45	46	XUART3_RXD	56	XUART3_RXD
N/A	N/A	GND	47	48	GND	N/A	N/A
N/A	N/A	GND	49	50	GND	N/A	N/A

Table 3. ARTIK 055s Interposer Board CON401 Connector Pinout and ARTIK Module Pin Mapping

ARTIK Module		Connector CON400				ARTIK Module	
Pin Name	Pin Number	Pin Name	Pin Number	Pin Number	Pin Name	Pin Number	Pin Name
XRESET_N	21	XRESET_N	1	2	XUART2_TXD	55	XUART2_TXD
XJTAG_TMS	22	XJTAG_TMS	3	4	XUART2_RXD	54	XUART2_RXD
XJTAG_TDI	23	XJTAG_TDI	5	6	XUART1_RXD	53	XUART1_RXD
XJTAG_TCK	24	XJTAG_TCK	7	8	XUART1_TXD	52	XUART1_TXD
XJTAG_TDO	25	XJTAG_TDO	9	10	GND	N/A	N/A
XJTAG_TRST_N	26	XJTAG_TRST_N	11	12	XSPIO_CLK	51	XSPIO_CLK
N/A	N/A	GND	13	14	XSPIO_MOSI	50	XSPIO_MOSI
XEINT0	28	XEINT0	15	16	XSPIO_CS	49	XSPIO_CSN
XEINT2	29	XEINT2	17	18	XSPIO_MISO	48	XSPIO_MISO
XEINT1	30	XEINT1	19	20	GND	N/A	N/A
PWR_RST	31	PWR_RST	21	22	RXD0	47	RXD0
XI2C0_SCL	33	XI2C0_SCL	23	24	TXD0	46	TXD0
XI2C0_SDA	34	XI2C0_SDA	25	26	GND	N/A	N/A
XI2C1_SCL	35	XI2C1_SCL	27	28	XPWM3_OUT	45	XPWMTOUT_3
XI2C1_SDA	36	XI2C1_SDA	29	30	XPWM2_OUT	44	XPWMTOUT_2
N/A	N/A	GND	31	32	XPWM5_OUT	43	XPWMTOUT_5
XDEBUG_TXD	37	XDEBUG_TXD	33	34	XPWM0_OUT	42	XPWMTOUT_0
XDEBUG_RXD	38	XDEBUG_RXD	35	36	XPWM1_OUT	41	XPWMTOUT_1

Table 3. ARTIK 055s Interposer Board CON401 Connector Pinout and ARTIK Module Pin Mapping (Continued)

ARTIK Module		Connector CON400				ARTIK Module	
Pin Name	Pin Number	Pin Name	Pin Number	Pin Number	Pin Name	Pin Number	Pin Name
N/A	N/A	N/C	37	38	XPWM4_OUT	40	XPWMTOUT_4
N/A	N/A	N/C	39	40	N/C	N/A	N/A
N/A	N/A	N/C	41	42	GND	N/A	N/A
EXT_5V_12V	32	DC_5V_12V	43	44	GND	N/A	N/A
		DC_5V_12V	45	46	GND	N/A	N/A
		DC_5V_12V	47	48	GND	N/A	N/A
		DC_5V_12V	49	50	GND	N/A	N/A

ARTIK 055s STARTER BOARD

The ARTIK 055s Development Kits includes a Starter Board which connects to the Interposer board. This section is divided into interface types and connector types on the Starter board.

Starter Board Interfaces

This section describes the various interfaces on the Starter board.

Power Interface

Power to the ARTIK 055s Starter Kit can be sourced from the micro-USB connector, a 5 - 12V DC Jack, or a 5.6 - 6.4V battery. *Table 4* shows the jumper settings to select each of the power sources. Note that pins 1 - 2 are located closest to the edge of the board.

Table 4. Power Configuration Jumper Settings

CON705 Power Jumper Connections	Power Source	Description
1 - 2	micro-USB (CON700)	Power is applied by the micro-USB connector. The pinout of the USB connector is as follows: Pin 1: VCC_USBP0 power Pin 2: D- Pin 3: D+ Pin 4: NC Pins 5 - 11: Ground
3 - 4	DC Jack (CON712)	Power is supplied by the DC power jack. The pinout of the DC jack is as follows: Pin 1: 5V - 12V DC power Pin 2: Ground Pin 3: Ground
5 - 6	2-pin header (CON706)	Power is supplied by a battery connected to CON706 as shown below. The pinout of the battery connector is as follows: Pin 1: 5V - 12V external battery power Pin 2: Ground Pin 1 of the battery connector is not identified on the silkscreen but rather by the square pad on the bottom of the Starter board. Pin 1 is also shown in <i>Figure 4</i> .

Figure 4 shows the location of the power-related connectors on the Starter board.

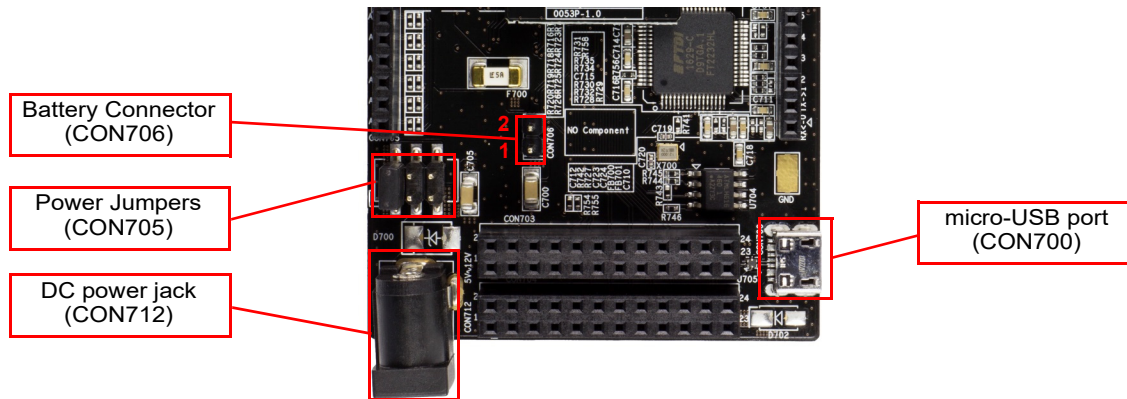

Figure 4. Location of Power Connectors on the Starter Board

micro-USB Interface

The Starter board has one micro-USB connector located as shown in *Figure 4*. The USB port can be used to program the module.

JTAG Interface

The Starter board provides a JTAG interface that can be used with trace and debugging equipment. In addition to showing the location of the connector, *Figure 5* also shows a JTAG to SWD interface cable/adapter to convert from the mini-JTAG connector to a common SWD connector used by many trace/debug instruments. The cable/adapter set shown is available from Adafruit (www.adafruit.com).

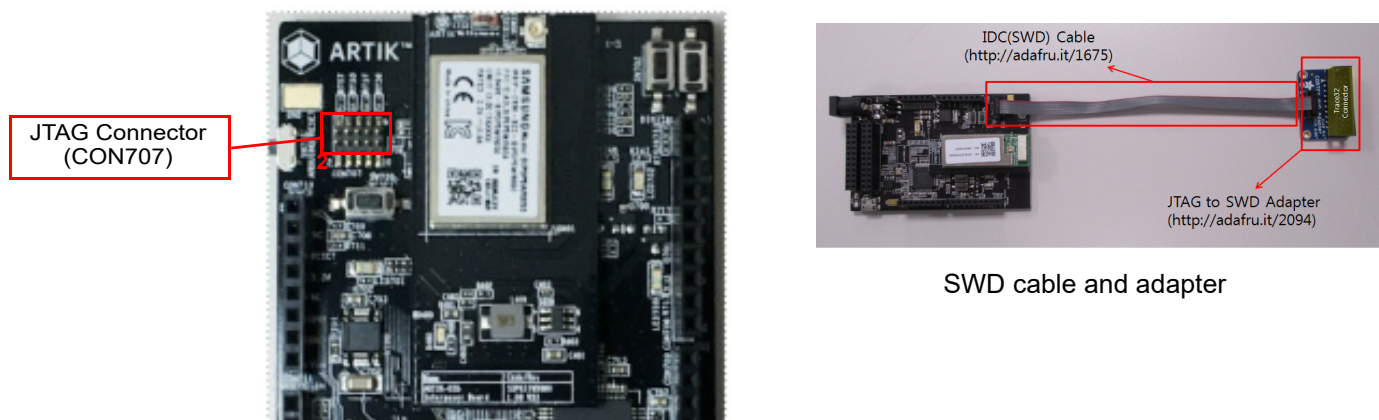

Figure 5. JTAG Connector Location on Starter Board

The pinout of the JTAG connector is shown in *Table 5*.

Table 5. JTAG Connector Pinout

Pin Name	Pin Number	Pin Number	Pin Name
XJTAG_TMS	1	2	VCC_EXT3P3
XJTAG_TCK	3	4	GND
XJTAG_TDO	5	6	GND
XJTAG_TDI	7	8	NC
XJTAG_TRST_N	9	10	GND

Pushbutton Switches

The ARTIK 055s Starter board includes four push button switches used for various purposes as shown in [Figure 6](#).

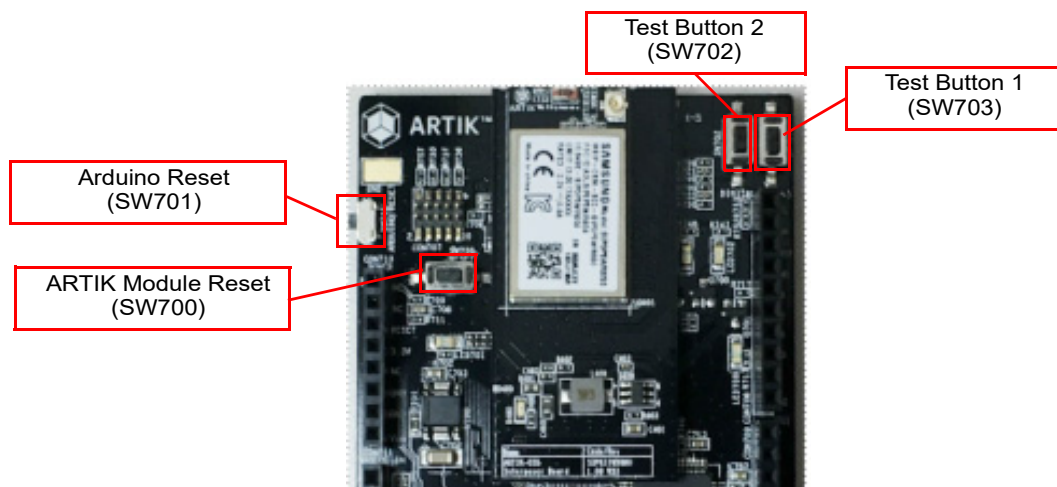

Figure 6. Location of Push Button Switches on the Starter Board

The pushbutton switches shown in [Figure 6](#) are defined in [Table 6](#).

Table 6. JTAG Connector Pinout

Switch Number	Switch Name	Description
SW700	ARTIK Module Reset	Connects the XRESET_N signal on the ARTIK module to ground.
SW701	Arduino Reset	Pressing this button initiates a reset on the Arduino connector interface.
SW702	Test Button 2	Pressing this button connects the XGPIO13 signal to ground. Can be used as an application specific input.
SW703	Test Button 1	Pressing this button connects the XGPIO15 signal to ground. Can be used as an application specific input.

LED Interface

The ARTIK 055s Starter board includes four LED's as shown in [Figure 7](#).

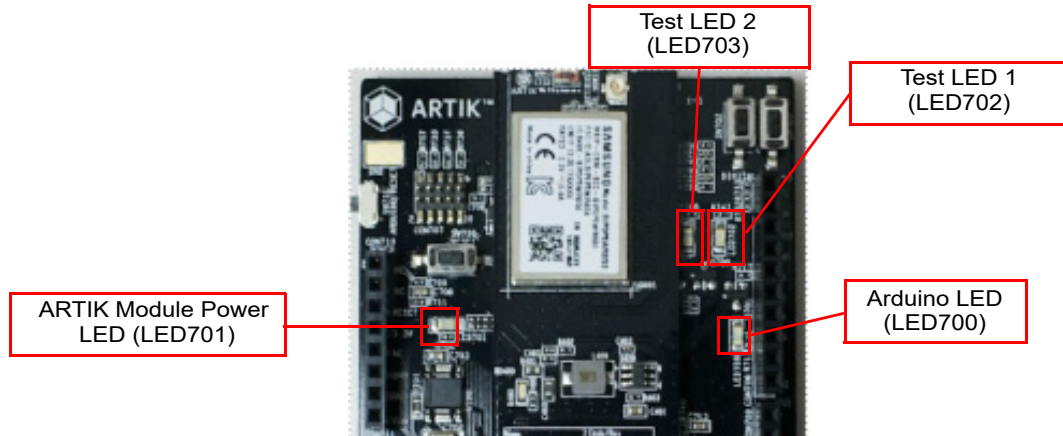

Figure 7. Location of Push Button Switches on the Starter Board

The LED's shown in [Figure 7](#) are defined in [Table 7](#).

Table 7. LED Interface Descriptions

LED Number	LED Name	Description
LED700	Arduino Interface LED	This red LED is illuminated by pin 6 of the Arduino 1 header located at CON708. It is used by applications that interface to the ARTIK module via the Arduino connectors.
LED701	ARTIK Module Power LED	This red LED is illuminated whenever power is applied to the ARTIK 055s Development Kit.
LED702	Test LED 1	This blue LED is connected to the XGPIO20 pin and can be used for an application specific output.
LED703	Test LED 2	This blue LED is connected to the XGPIO16 pin and can be used for an application specific output.

ARTIK 055s Starter Board Connectors

The ARTIK 055s Starter board contains two connector interfaces that are described in the following subsections.

- Single-row Arduino connectors (4)
- Dual-row Breakout connectors (2)

The relative location of each connector on the Starter board is shown in *Figure 8*.

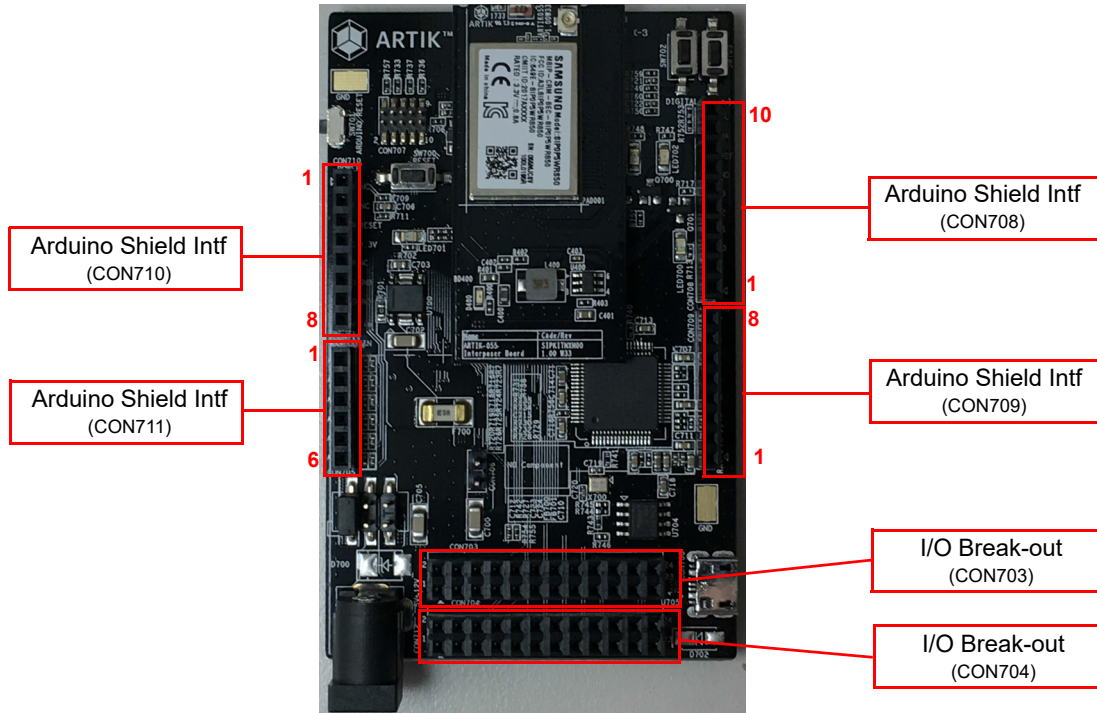

Figure 8. Location of Starter Board Interface Connectors

Arduino Connectors

The four Arduino connector pinouts shown in *Figure 8* are defined in *Table 8*. The location of pin 1 of each connector is shown in the figure.

Table 8. Arduino Interface Connector Pin Descriptions

Pin Number	Arduino Connectors			
	CON708	CON709	CON710	CON711
1	XGPIO21	XUARTO_RXD	N/C	XADCOAIN_0
2	XPWMOUT_4	XUARTO_TXD	N/C	XADCOAIN_1
3	XSPI1_CSN	XGPIO17	RESET	XADCOAIN_2
4	XSPI1_MOSI	XPWMTOUT_0	VCC_EXT3P3	XADCOAIN_3
5	XSPI1_MISO	XGPIO18	N/C	N/C
6	XSPI1_CLK	XPWMTOUT_1	GND	N/C
7	GND	XPWMTOUT_2	GND	—
8	N/C	XGPIO19	N/C	—
9	XI2CO_SDA	—	—	—

Table 8. Arduino Interface Connector Pin Descriptions (Continued)

Pin Number	Arduino Connectors			
	CON708	CON709	CON710	CON711
10	XI2C0_SCL	—	—	—

Break-out Connectors

The two Break-out connector pinouts shown in *Figure 8* are defined in *Table 9*. For each connector, the odd-numbered row is closest to the edge of the board and is noted on the silkscreen.

Table 9. Break-out Connector Pin Descriptions

Odd-Numbered Connector Row			Even-Numbered Connector Row		
Break-out Connectors		Connector Pin Number	Connector Pin Number	Break-out Connectors	
CON703	CON704			CON703	CON704
XPWNTOUT_1	XPWNTOUT_4	1	2	VDD_EXT3P3	VDD_EXT3P3
XPWNTOUT_2	XPWNTOUT_2	3	4	N/C	XUART2_RXD
XPWNTOUT_3	XEINT2	5	6	N/C	XUART2_TXD
XPWNTOUT_0	XEINT1	7	8	Xi2C1_SCL	XUART3_RXD
XUART1_RXD	XGPIO12	9	10	Xi2C1_SDA	XUART3_TXD
XUART1_TXD	XGPIO10	11	12	GND	GND
XGPIO26	XGPIO9	13	14	VCC_EXT3P3	VCC_EXT3P3
XGPIO25	XGPIO11	15	16	XSPIO_CLK	XGPIO4
XGPIO24	XGPIO8	17	18	XSPIO_CS	XGPIO5
XGPIO23	XGPIO2	19	20	XSPIO_MISO	XGPIO6
XGPIO22	XGPIO1	21	22	XSPIO_MOSI	XGPIO7
XEINT0	XGPIO3	23	24	GND	GND

Starter Board to Interposer Board Interface Connectors

The Starter board interfaces to the Interposer board via two 50-pin Hirose connectors. For more information on the pinout of these connectors, refer to the section above entitled *ARTIK 055s Interposer Board Connectors*.

MECHANICAL SPECIFICATIONS

The following figures show the mechanical specifications for the ARTIK 055s Interposer and Starter boards.

Starter Board Dimensions

Figure 9 shows the dimensions of the ARTIK 055s Starter board.

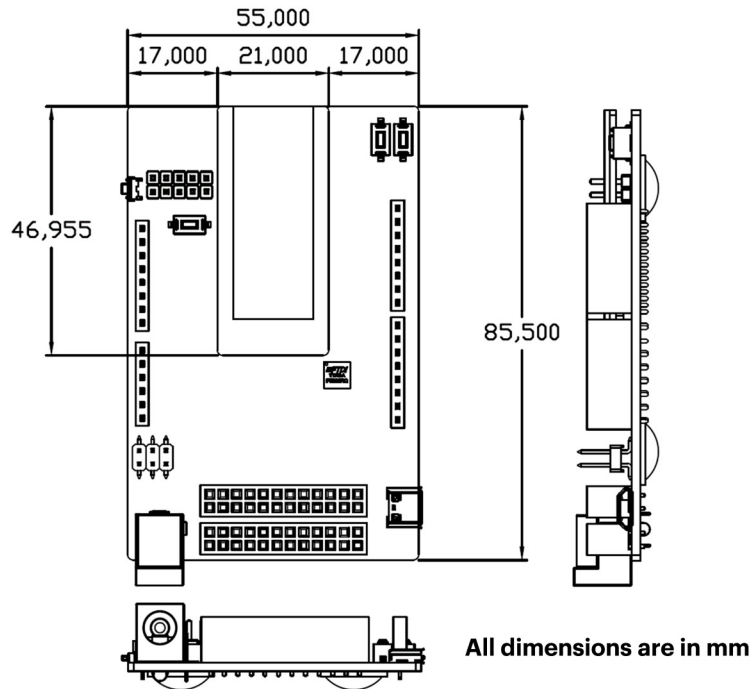

Figure 9. ARTIK 055s Starter Board Mechanical Specifications

ARTIK 055s Interposer Board and Module Dimensions

Figure 10 shows the dimensions of the ARTIK 055s Interposer board and module.

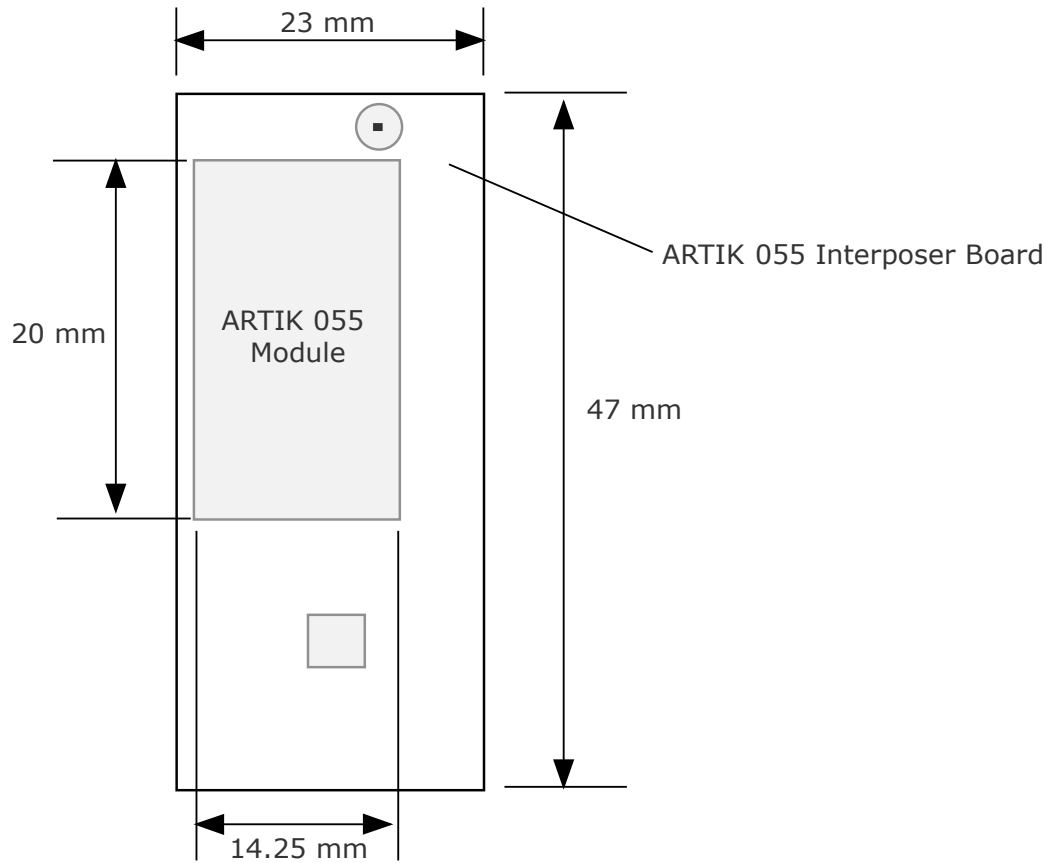

Figure 10. ARTIK 055s Interposer Board and Module Mechanical Specifications

LEGAL INFORMATION

INFORMATION IN THIS DOCUMENT IS PROVIDED IN CONNECTION WITH THE SAMSUNG ARTIK™ DEVELOPMENT KIT AND ALL RELATED PRODUCTS, UPDATES, AND DOCUMENTATION (HEREINAFTER "SAMSUNG PRODUCTS"). NO LICENSE, EXPRESS OR IMPLIED, BY ESTOPPEL OR OTHERWISE, TO ANY INTELLECTUAL PROPERTY RIGHTS IS GRANTED BY THIS DOCUMENT. THE LICENSE AND OTHER TERMS AND CONDITIONS RELATED TO YOUR USE OF THE SAMSUNG PRODUCTS ARE GOVERNED EXCLUSIVELY BY THE SAMSUNG ARTIK™ DEVELOPER LICENSE AGREEMENT THAT YOU AGREED TO WHEN YOU REGISTERED AS A DEVELOPER TO RECEIVE THE SAMSUNG PRODUCTS. EXCEPT AS PROVIDED IN THE SAMSUNG ARTIK™ DEVELOPER LICENSE AGREEMENT, SAMSUNG ELECTRONICS CO., LTD. AND ITS AFFILIATES (COLLECTIVELY, "SAMSUNG") ASSUMES NO LIABILITY WHATSOEVER, INCLUDING WITHOUT LIMITATION CON. SAMSUNG RESERVES THE RIGHT TO CHANGE PRODUCTS, INFORMATION, DOCUMENTATION AND SPECIFICATIONS WITHOUT NOTICE. THIS INCLUDES MAKING CHANGES TO THIS DOCUMENTATION AT ANY TIME WITHOUT PRIOR NOTICE. THIS DOCUMENTATION IS PROVIDED FOR REFERENCE PURPOSES ONLY, AND ALL INFORMATION DISCUSSED HEREIN IS PROVIDED ON AN "AS IS" BASIS, WITHOUT WARRANTIES OF ANY KIND. SAMSUNG ASSUMES NO RESPONSIBILITY FOR POSSIBLE ERRORS OR OMISSIONS, OR FOR ANY CONSEQUENCES FROM THE USE OF THE DOCUMENTATION CONTAINED HEREIN.

Samsung Products are not intended for use in medical, life support, critical care, safety equipment, or similar applications where product failure could result in loss of life or personal or physical harm, or any military or defense application, or any governmental procurement to which special terms or provisions may apply.

This document and all information discussed herein remain the sole and exclusive property of Samsung. All brand names, trademarks and registered trademarks belong to their respective owners. For updates or additional information about Samsung ARTIK™, contact the Samsung ARTIK™ team via the Samsung ARTIK™ website at www.artik.io.

Copyright © 2017 Samsung Electronics Co., Ltd.

All rights reserved. No part of this publication may be reproduced, stored in a retrieval system, or transmitted in any form or by any means, electric or mechanical, by photocopying, recording, or otherwise, without the prior written consent of Samsung Electronics.

SAMSUNG ELECTRONICS RESERVES THE RIGHT TO CHANGE PRODUCTS, INFORMATION AND SPECIFICATIONS WITHOUT NOTICE.

Products and specifications discussed herein are for reference purposes only. All information discussed herein is provided on an "AS IS" basis, without warranties of any kind. This document and all information discussed herein remain the sole and exclusive property of Samsung Electronics. No license of any patent, copyright, mask work, trademark or any other intellectual property right is granted by one party to the other party under this document, by implication, estoppel or other-wise. Samsung products are not intended for use in life support, critical care, medical, safety equipment, or similar applications where product failure could result in loss of life or personal or physical harm, or any military or defense application, or any governmental procurement to which special terms or provisions may apply. For updates or additional information about Samsung products, contact your nearest Samsung office. All brand names, trademarks and registered trademarks belong to their respective owners.