

PXD15-xxSxx Single Output DC/DC Converter

9 to 75 Vdc input, 3.3 to 15 Vdc Single Output, 15W



Features

- Low profile: 2.0X1.0X0.4 inches (50.8X25.4X10.2mm)
- 2:1 wide input voltage of 9-18, 18-36 and 36-75VDC
- 15 Watts output power
- Input to output isolation: 1600Vdc, min
- Operating case temperature range :100°C max
- Over-current protection, auto-recovery
- Output over voltage protection
- ISO 9001 certified manufacturing facilities
- UL60950-1, EN60950-1 and IEC60950-1 licensed
- CE Mark meet 2006/95/EC, 93/68/EEC and 2004/108/EC
- Compliant to RoHS EU directive 2002/95/EC

Applications

- Distributed power architectures
- Communication equipment
- Computer equipment

Option

- Positive logic & Negative logic Remote on/off

General Description

The PXD15-xxSxx series offers 15 watts of output power from a 2 x 1 x 0.4 inch package. This series has a 2:1 wide input voltage of 9-18, 18-36 or 36-75VDC.

Table of contents

Absolute maximum rating	P2	Solder, clearing, and drying considerations	P8
Output Specifications	P2	Characteristic curve	P9
Input Specifications	P3	Test configurations	P17
General Specifications	P3	Part number structure	P18
Remote on/off control	P4	Mechanical data	P18
Thermal Consideration	P5	Safety and installation instruction	P19
Output over current protection	P7	MTBF and Reliability	P19
Short circuit protection	P7		

Absolute Maximum Rating					
Parameter	Device	Min	Typ	Max	Unit
Input Voltage Continuous Transient (100ms)	12Sxx			36	Vdc
	24Sxx			50	Vdc
	48Sxx			100	Vdc
Operating temperature range(With De-rating curve)	Standard	-40		+85	°C
Operating case range	All			100	°C
Storage temperature	All	-55		+105	°C
I/O Isolation voltage	All	1600			Vdc
I/O Isolation capacitance	All			300	pF

Output Specifications					
Parameter	Device	Min	Typ	Max	Unit
Operating Output Range	xxS3P3	3.267	3.30	3.333	Vdc
	xxS05	4.95	5.00	5.05	Vdc
	xxS12	11.88	12.00	12.12	Vdc
	xxS15	14.85	15.00	15.15	Vdc
Line Regulation(LL to HL at Full Load)	All	-0.5		0.5	%
Load Regulation(Min. to 100% Full Load)	All	-0.5		0.5	%
Output Ripple & Noise (20MHz bandwidth)	All			50	mVp-p
Temperature Coefficient	All	-0.02		+0.02	%/°C
Transient Response Recovery Time (25% load step change)	All		250		uS
Output Current	xxS3P3	0		4000	
	12S05	15		3000	
	12S12	0		1250	
	12S15	0		1000	mA
	24S05	15		3000	mA
	24S12	0		1250	mA
	24S15	10		1000	mA
	48S05	0		3000	
	48S12	10		1250	
48S15	0		1000		
Output Over Voltage Protection Zener diode clamp	xxS3P3		3.9		Vdc
	xxS05		6.2		Vdc
	xxS12		15		Vdc
	xxS15		18		Vdc
Output Over Current Protection	All		150		% FL.
Output Short Circuit Protection	All	Hiccup, automatics recovery			
Output Capacitor Load	xxS3P3			10200	μF
	xxS05			7050	μF
	xxS12			1035	μF
	xxS15			705	μF

Input Specifications					
Parameter	Device	Min	Typ	Max	Unit
Operating Input voltage	12Sxx	9	12	18	Vdc
	24Sxx	18	24	36	Vdc
	48Sxx	36	48	75	Vdc
Input reflected ripple current (please see the testing configurations part.)	All		20		mAp-p
Start up time (nominal vin and constant resistive load power up)	All		20		mS
Remote ON/OFF					
Negative Logic	DC-DC ON	All	0	1.2	Vdc
	DC-DC OFF	All	3.5	12	Vdc
Positive Logic	DC-DC ON	All	3.5	12	Vdc
	DC-DC OFF	All	0	1.2	Vdc

General Specifications					
Parameter	Device	Min	Typ	Max	Unit
Efficiency Vin=nom and full load	12S3P3		79		%
	12S05		82		%
	12S12		86		%
	12S15		86		%
	24S3P3		80		%
	24S05		84		%
	24S12		85		%
	24S15		85		%
	48S3P3		81		%
	48S05		83		%
	48S12		87		%
48S15		86		%	
Isolation resistance	All	10 ⁹			Ω
Isolation Capacitance	All			300	pF
Switching Frequency (Vin, nom and full load)	All		500		KHz
Weight	All		27		g
MTBF	All		2.041×10 ⁶		hours

Remote On/Off Control

The Remote ON/OFF pin is used to turn the DC/DC converter on and off. The user must use a switch to control the logic voltage (high or low) level of the pin referenced to -Vin. The switch can be an open collector transistor, FET, or opto-Coupler. The switch must be capable of sinking up to 0.5 mA for a low-level logic voltage. For a high logic level for the ON/OFF signal, the allowable leakage current of the switch at 12V is 0.5mA.

Remote ON/OFF Implementation Circuits

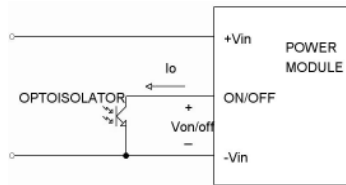

Isolated-Control Remote ON/OFF

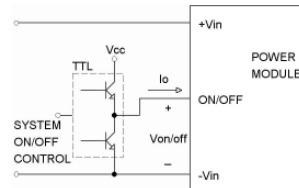

Level Control Using TTL Output

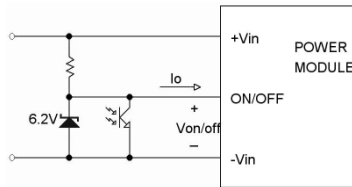

Level Control Using Line Voltage

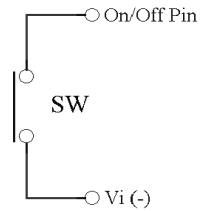

PXD15-xxSxx is turned off with Low-level logic

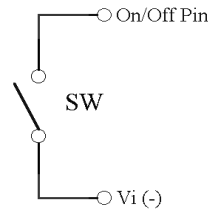

PXD15-xxSxx is turned on with High-level logic

Thermal Consideration

The power module operates in a variety of thermal environments. Sufficient cooling should be provided to help ensure reliable operation of the unit. Heat is removed by conduction, convection, and radiation to the surrounding environment. Proper cooling can be verified by measuring the point as shown in the figure below. The temperature at this location should not exceed 100°C. When Operating, adequate cooling must be provided to maintain the test point temperature at or below 100°C. Although the maximum temperature of the power modules is 100°C, lowering this temperature will increase the reliability of the unit.

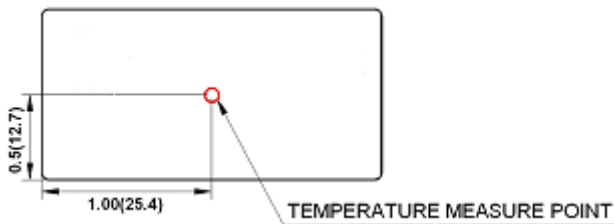

Measurement shown in inches(mm)

TOP VIEW

Following are de-rating curves for PXD15-12S05, PXD15-24S3P3, PXD15-48S12

PXD15-12S05

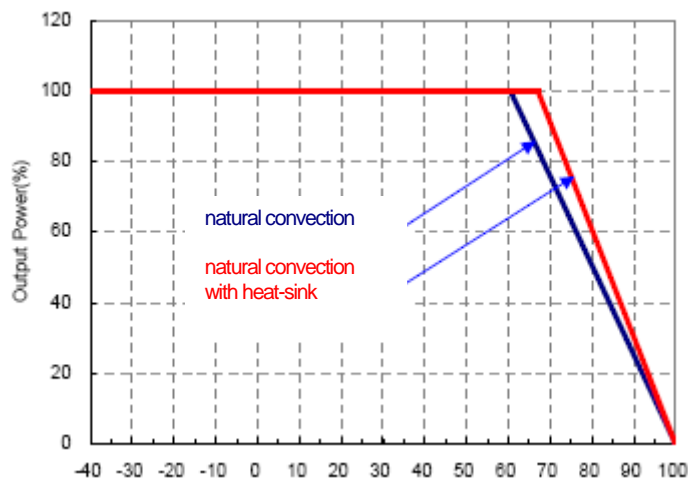

PXD15-24S3P3

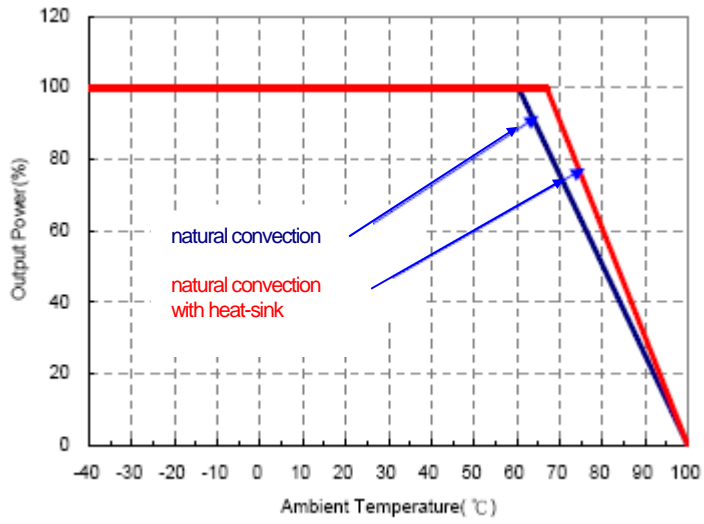

PXD15-48S12

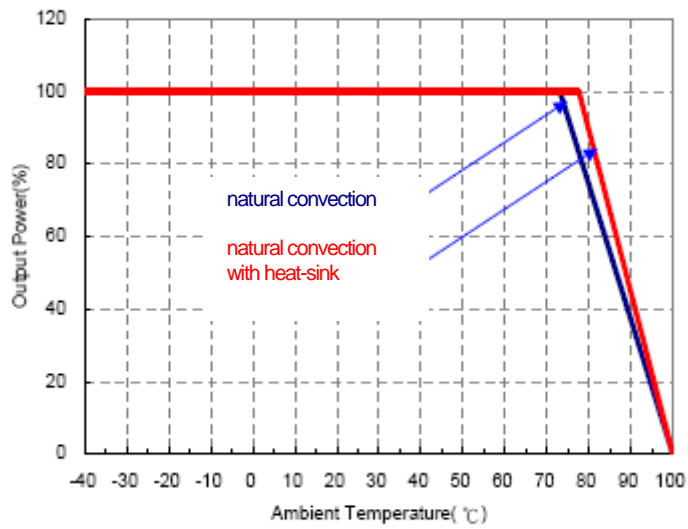

Output over current protection

When excessive output currents occur in the system, circuit protection is required on all converters. Normally, overload current is maintained at approximately 150 percent of rated current for PxD15-xxDxx series..

Hiccup-mode is a method used in a converter whose purpose is to protect the converter from being damaged during an over-current fault condition. It also enables the converter to restart when the fault is removed. There are other ways of protecting the converter when it is over-loaded, such as the maximum current limiting or the current foldback method.

One of the problems resulting from over current is that excessive heat may be generated in power devices; especially MOSFET and Schottky diodes and the temperature of these devices may exceed their specified limits. A protection mechanism has to be used to prevent these power devices from being damaged.

The operation of hiccup is as follows. When the current sense circuit sees an over-current event, the controller shuts off the converter for a given time and then tries to re-start the converter. If the over-load condition has been removed, the converter will start-up and operate normally; otherwise, the controller will see another over-current event and shut off the converter again, repeating the previous cycle. Hiccup operation has none of the drawbacks of the other two protection methods, although it's circuit is more complicated because it requires a timing circuit. The excess heat due to overload lasts for only a short duration in the hiccup cycle, hence the junction temperature of the power devices is much lower.

Short Circuitry Protection

Continuous, hiccup and auto-recovery mode.

During short circuit, converter still shut down. The average current during this condition will be very low and the device can be safety in this condition.

Soldering and Reflow Consideration

Lead free wave solder profile for PXD15-xxSxx DIP type

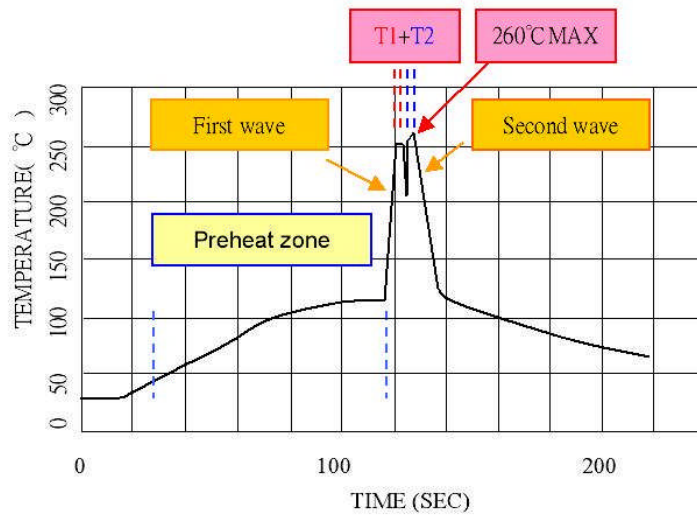

Zone	Reference Parameter
Preheat zone	Rise temp. speed : 3°C / sec max. Preheat temp. : 100~130°C
Actual heating	Peak temp. : 250~260°C Peak time (T1+T2 time) : 4~6 sec

Reference Solder: Sn-Ag-Cu/Sn-Cu

Hand Welding: Soldering iron-Power 90W

Welding Time:2-4 sec

Temp.: 80-400 °C

Characteristic Curve

Efficiency

a. Efficiency with load change under different line condition at room temperature

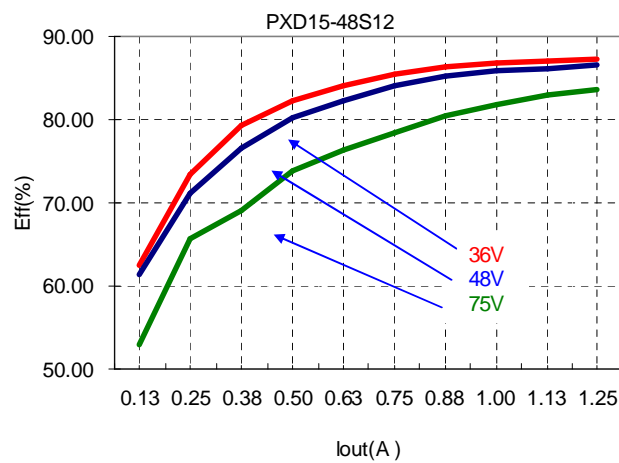
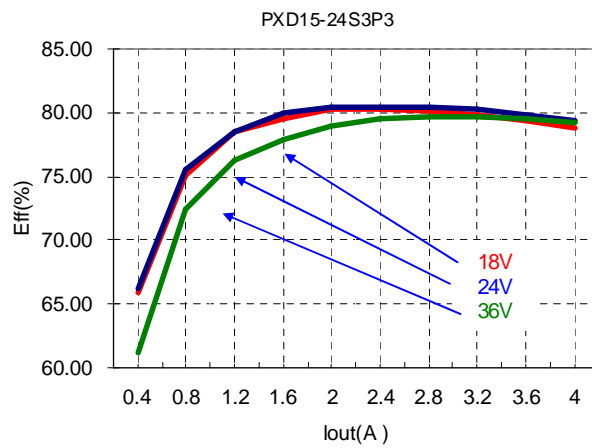
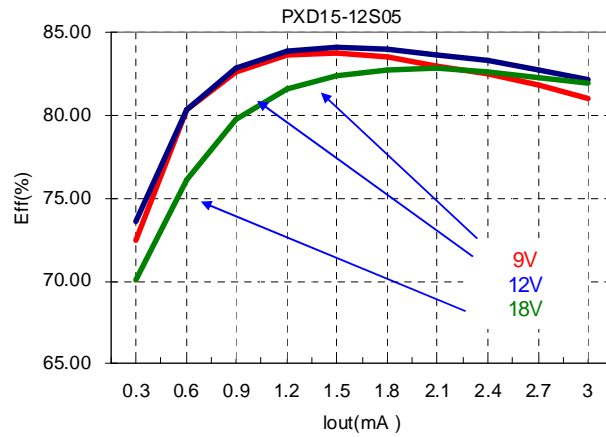

b. Efficiency with line change under different load condition at room temperature

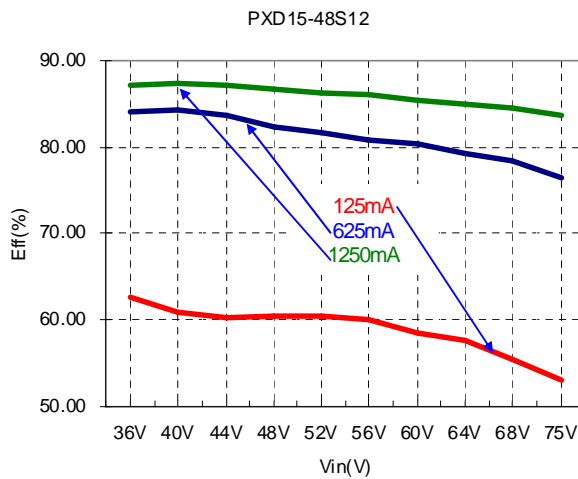
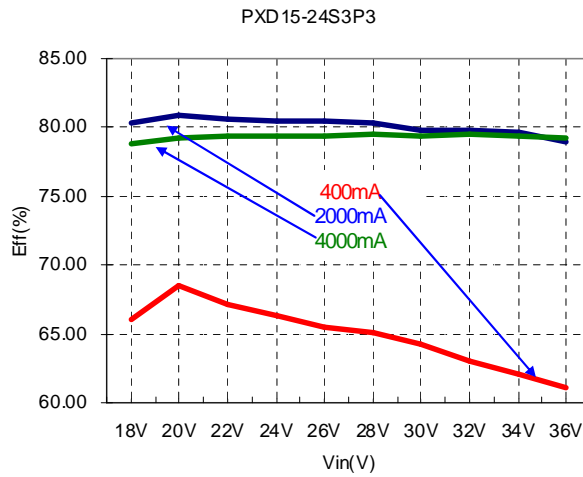
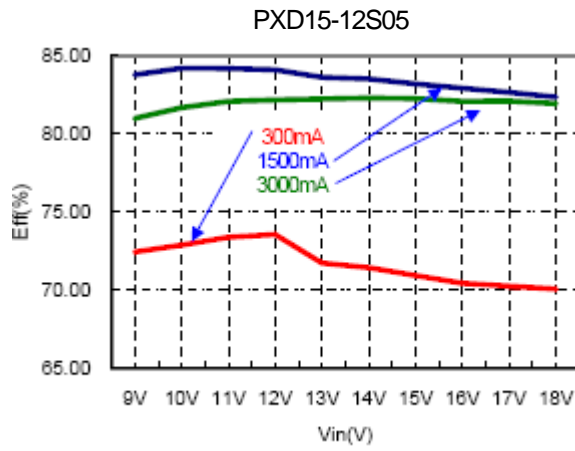

Power dissipation curve

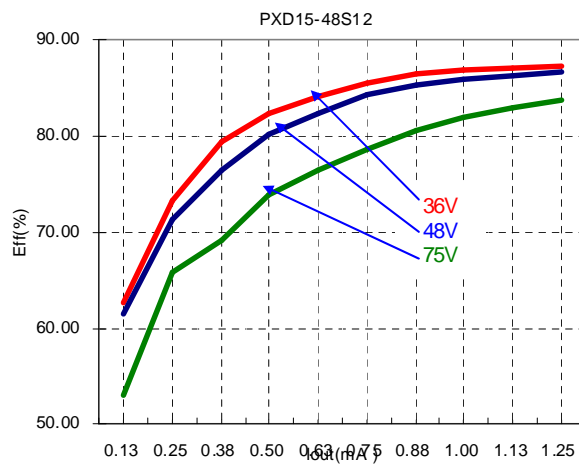
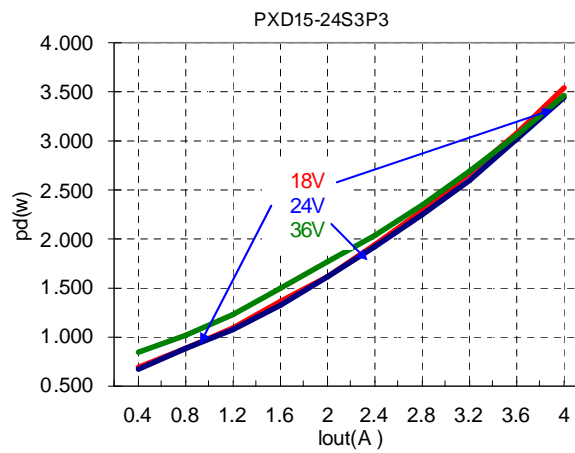
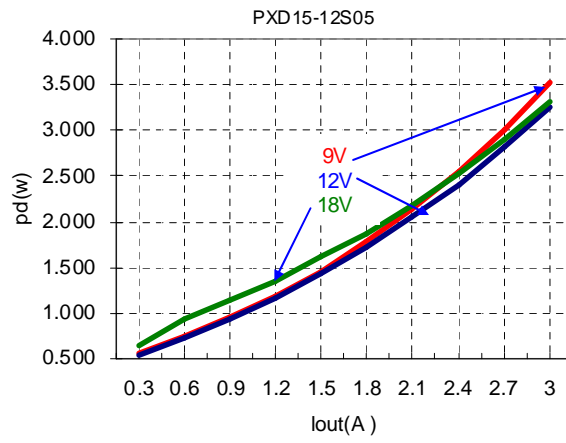

Output ripple & noise

PXD15-12S05

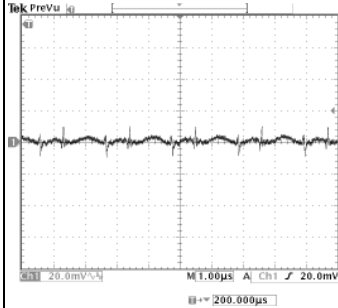

Low Line, Full Load
Output Ripple Noise=19.6mV

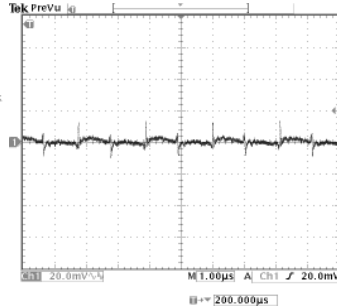

Normal Line, Full Load
Output Ripple Noise=22.8mV

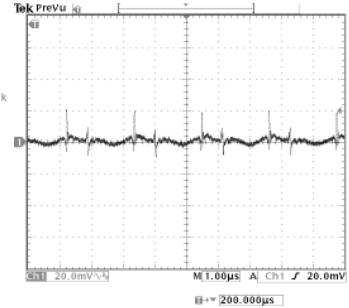

High Line, Full Load
Output Ripple Noise=29.6mV

PXD15-24S3P3

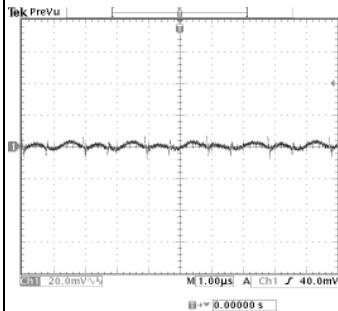

Low Line, Full Load
Output Ripple Noise=15.2mV

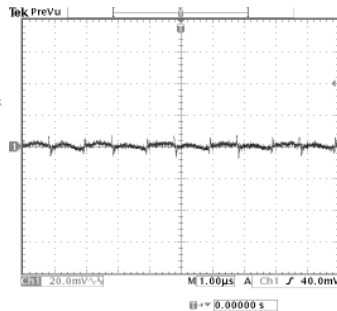

Normal Line, Full Load
Output Ripple Noise=15.6mV

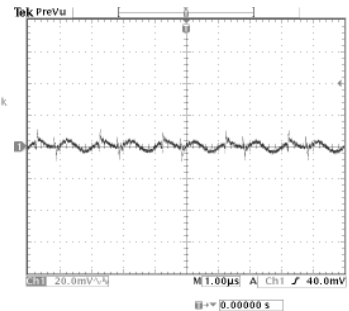

High Line, Full Load
Output Ripple Noise=20.0mV

PXD15-48S12

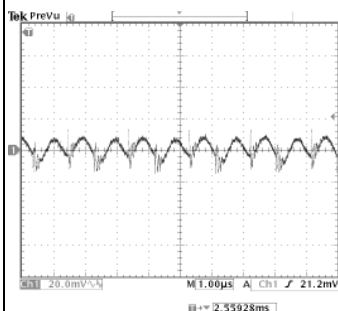

Low Line, Full Load
Output Ripple Noise= 28.4

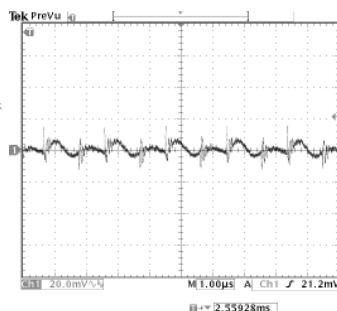

Normal Line, Full Load
Output Ripple Noise=27.6mV

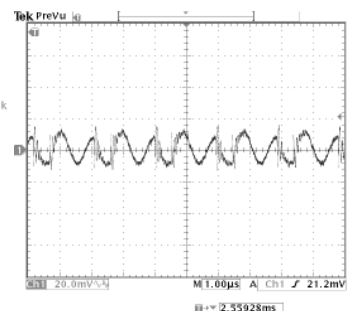

High Line, Full Load
Output Ripple Noise=29.6mV

Transient Peak and Response

PXD15-12S05

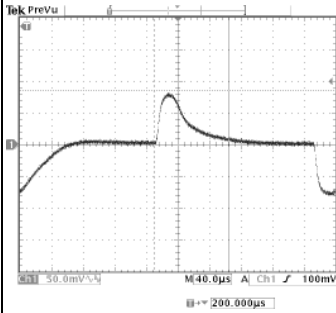

Low Line, Full Load
 Transient Peak 85.0mV
 Transient Response 95.2µs

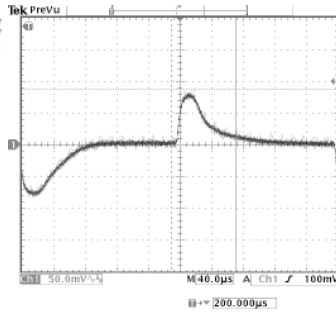

Normal Line, Full Load
 Transient Peak 88.0mV
 Transient Response 80.8µs

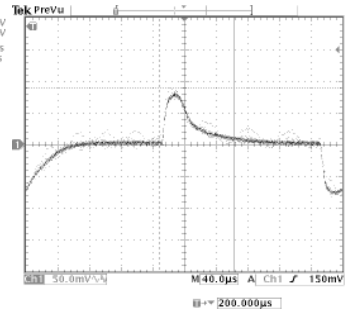

High Line, Full Load
 Transient Peak 89.0mV
 Transient Response 95.2µs

PXD15-24S3P3

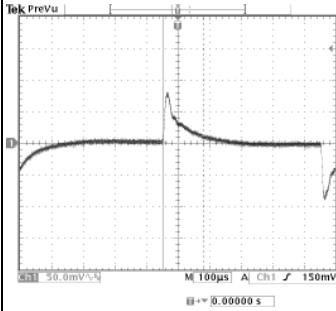

Low Line, Full Load
 Transient Peak 81.0mV
 Transient Response 130µs

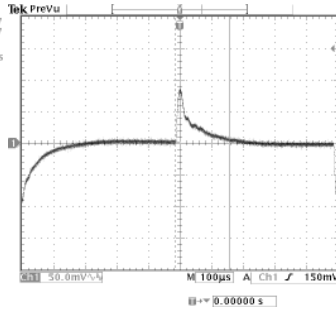

Normal Line, Full Load
 Transient Peak 86.0mV
 Transient Response 170µs

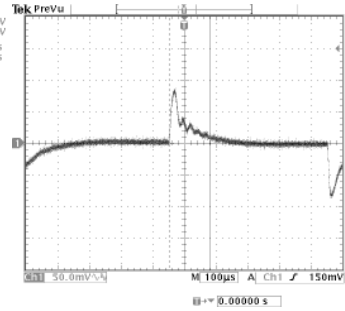

High Line, Full Load
 Transient Peak 45.6mV
 Transient Response 200µs

PXD15-48S12

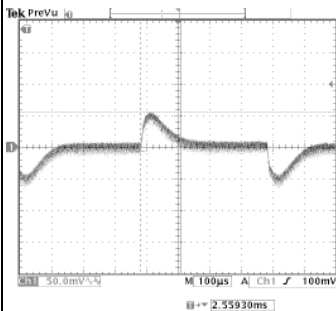

Low Line, Full Load
 Transient Peak 56mV
 Transient Response 130µs

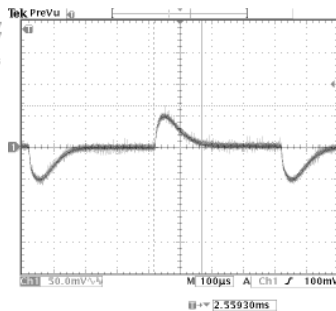

Normal Line, Full Load
 Transient Peak 66mV
 Transient Response 150µs

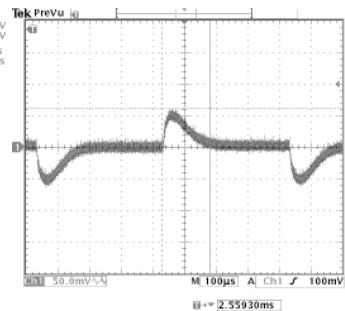

High Line, Full Load
 Transient Peak 62mV
 Transient Response 150µs

Inrush Current

PXD15-12S05

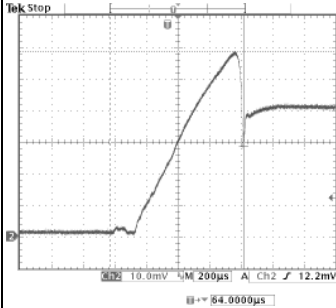

Low Line, Full Load

Inrush current=(58.6/10) X500mA=2930mA
 Duration: 848µs

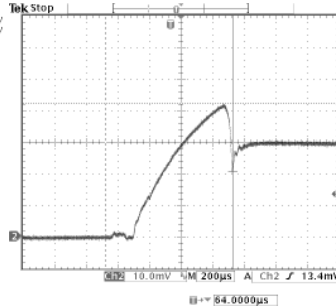

Normal Line, Full Load

Inrush current=(42.2/10) x500mA=2210mA
 Duration: 808µs

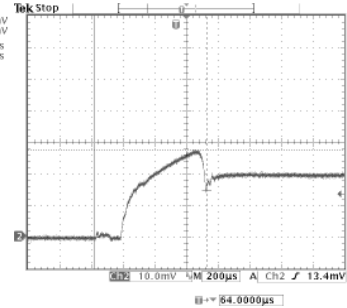

High Line, Full Load

Inrush current=(27.4/10) x500mA=1370mA
 Duration: 712µs

PXD15-24S3P3

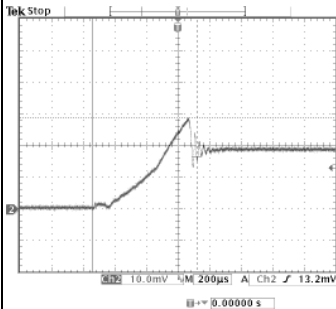

Low Line, Full Load

Inrush current=(29.2/10) X500mA=1460mA
 Duration: 664µs

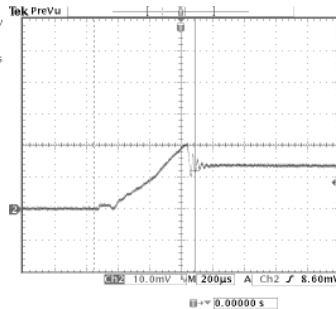

Normal Line, Full Load

Inrush current=(20.8/10) x500mA=1040mA
 Duration: 640µs

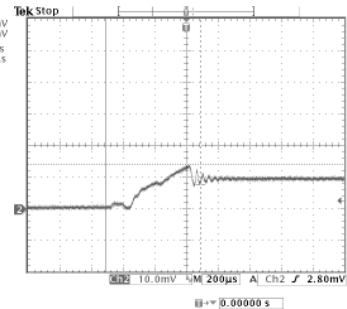

High Line, Full Load

Inrush current=(14.4/10) x500mA=720mA
 Duration: 600µs

PXD15-48S12

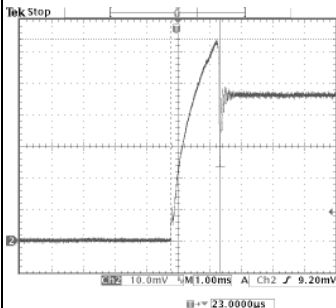

Low Line, Full Load

Inrush current=(63.8/10) X100mA=638mA
 Duration: 1.58ms

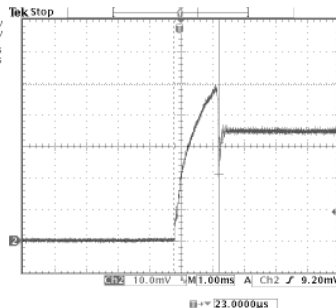

Normal Line, Full Load

Inrush current=(49.6/10) x100mA=496mA
 Duration: 1.44ms

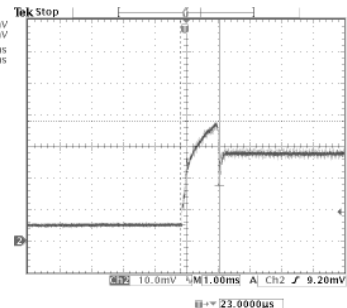

High Line, Full Load

Inrush current=(37.8/10) x100mA=378mA
 Duration: 1.22ms

Input Ripple Current

PXD15-12S05

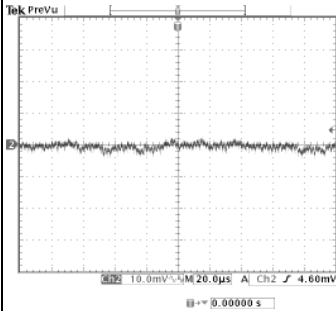

Low Line, Full Load
Ripple current=(7.6/10) x5=3.8mA

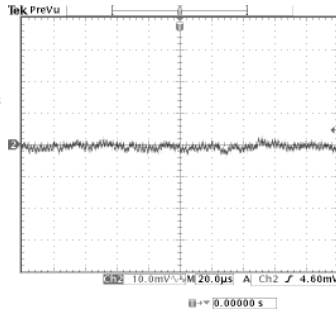

Normal Line, Full Load
Ripple current=(5.8/10) x5=2.9mA

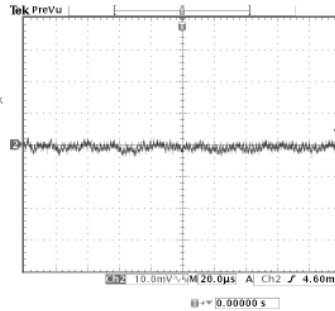

High Line, Full Load
Ripple current=(6.4/10) x5=3.2mA

PXD15-24S3P3

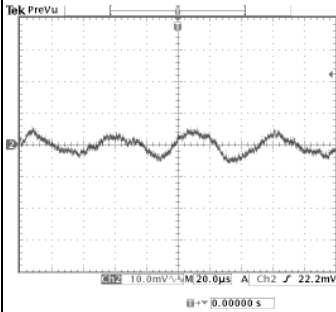

Low Line, Full Load
Ripple current=(12/10) x5=6.0mA

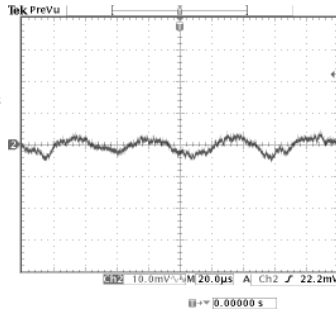

Normal Line, Full Load
Ripple current=(10.2/10) x5=5.1mA

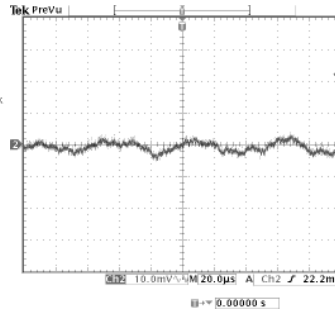

High Line, Full Load
Ripple current=(9/10) x5=4.5mA

PXD15-48S12

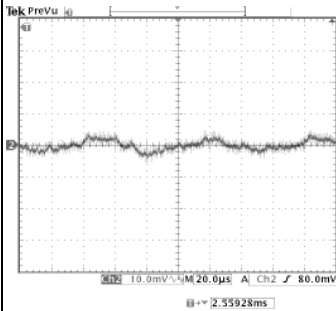

Low Line, Full Load
Ripple current=(10.4/10) x5=5.2mA

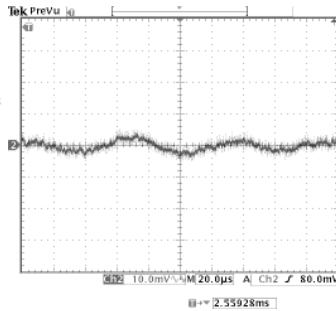

Normal Line, Full Load
Ripple current=(7.8/10) x5=3.9mA

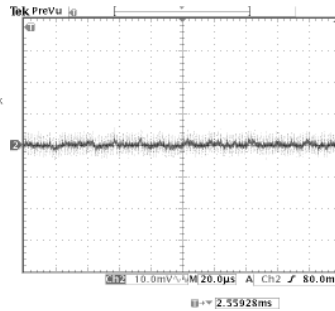

High Line, Full Load
Ripple current=(9.8/10) x5=4.9mA

Delay Time and Rise Time

PXD15-12S05

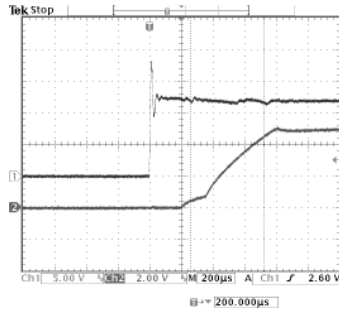

Normal Line, Full Load
Rise Time=464.1uS

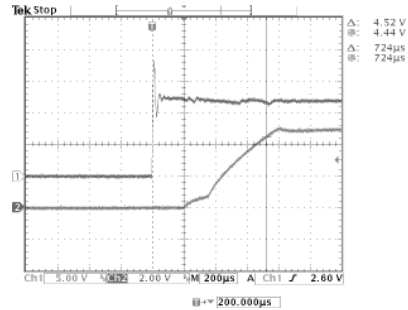

Normal Line, Full Load
Delay Time= 724uS

PXD15-24S3P3

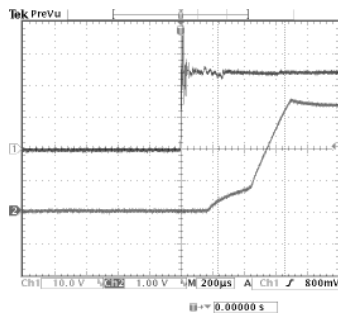

Normal Line, Full Load
Rise Time=425.2uS

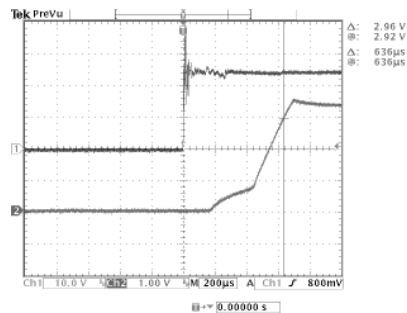

Normal Line, Full Load
Delay Time= 636uS

PXD15-48S12

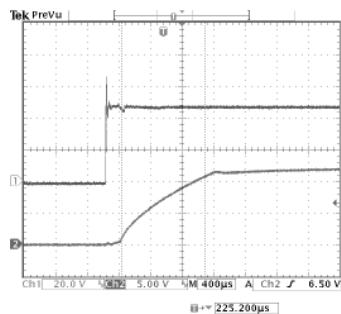

Normal Line, Full Load
Rise Time=1.053mS

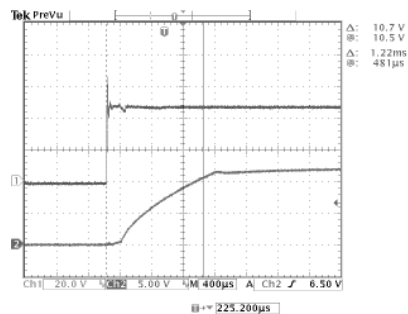

Normal Line, Full Load
Delay Time= 1.22mS

Testing Configurations

Input Reflected-ripple Current Measurement Test:

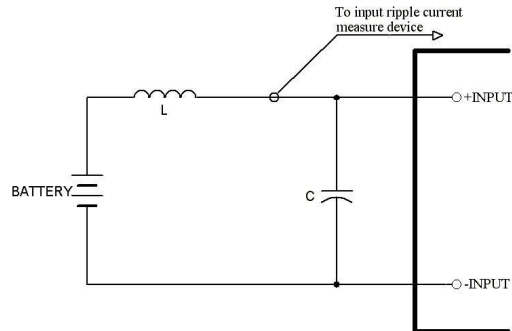

Component	Value	Voltage	Reference
L	12μH	----	----
C	100μF	100V	Aluminum Electrolytic Capacitor

Peak-to-Peak Output Ripple & Noise Measurement Test:

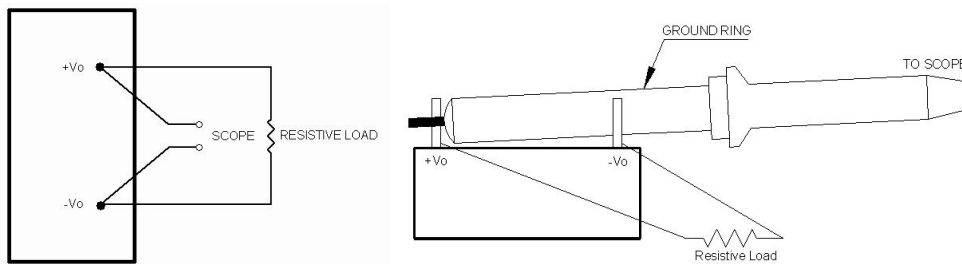

Output Voltage and Efficiency Measurement Test:

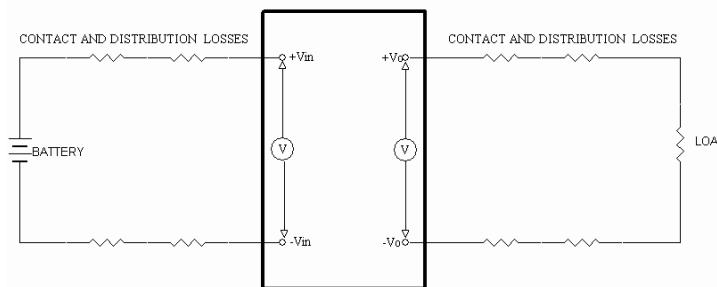

Note: All measurements are taken at the module terminals.

$$Efficiency = \left(\frac{V_o \times I_o}{V_{in} \times I_{in}} \right) \times 100\%$$

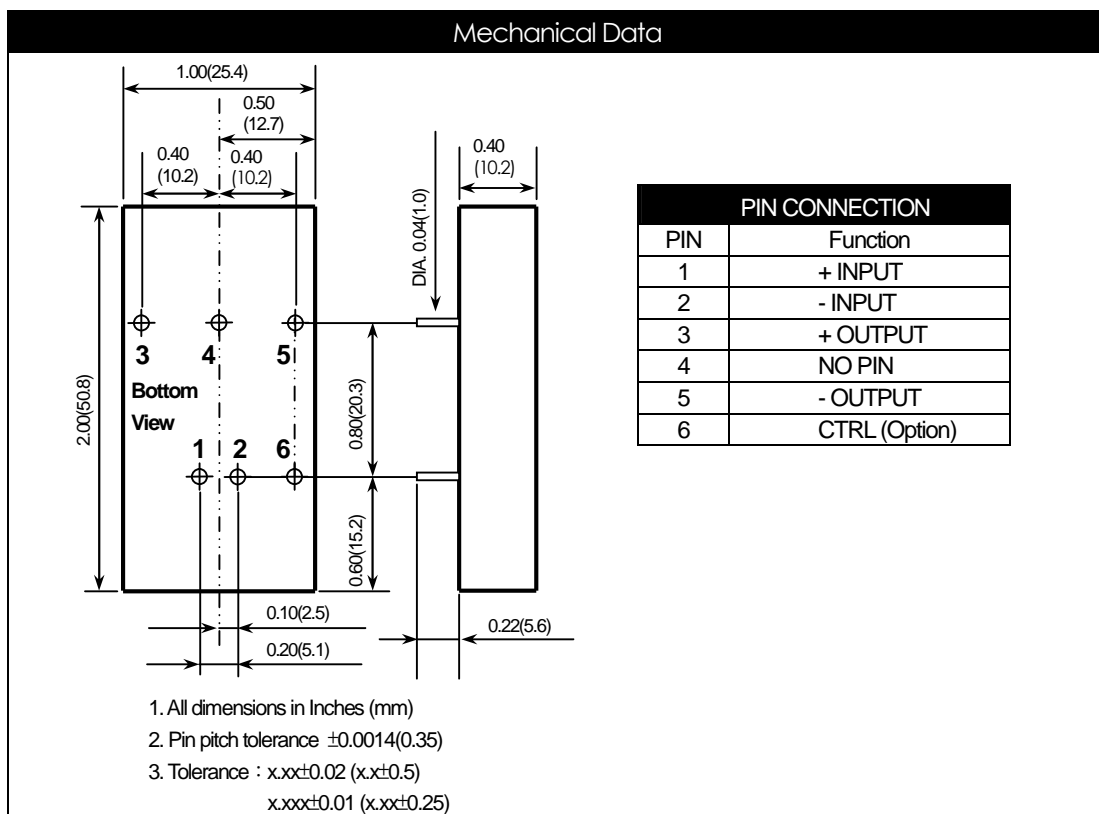
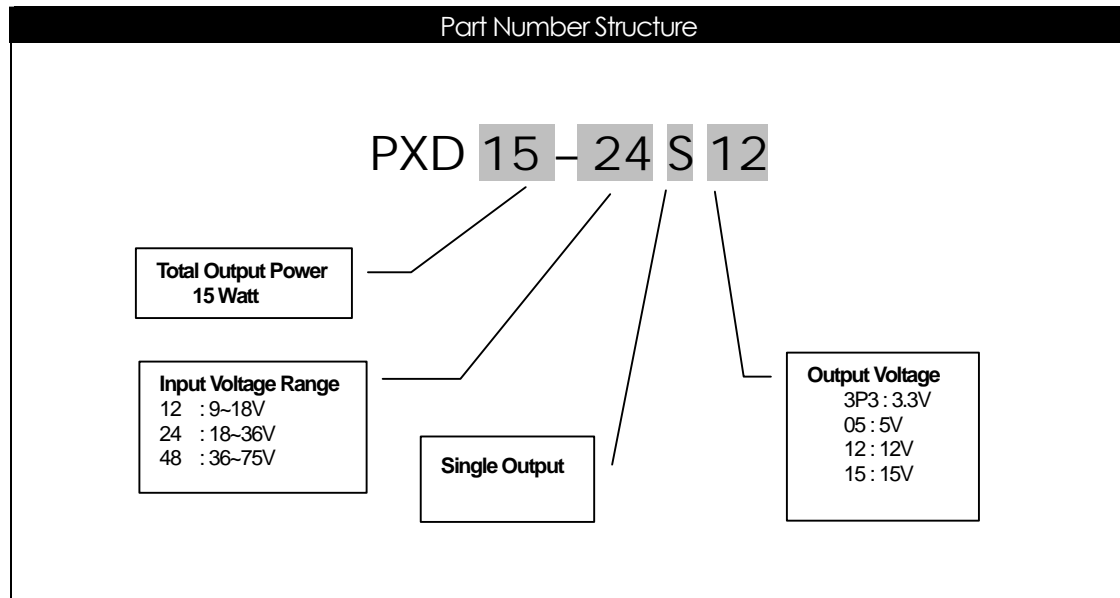

Safety and Installation Instruction

Isolation consideration

The PXD15-xxSxx series features 1.6k Volt DC isolation from input to output, input to case, and output to case. The input to output resistance is greater than 10^9 ohms. Nevertheless, if the system using the power module needs to receive safety agency approval, certain rules must be followed in the design of the system using the model. In particular, all of the creepage and clearance requirements of the end-use safety requirement must be observed. These documents include UL-60950-1, EN60950-1 and CSA 22.2-960, although specific applications may have other or additional requirements.

Fusing Consideration

Caution: This power module is not internally fused. An input line fuse must always be used. This encapsulated power module can be used in a wide variety of applications, ranging from simple stand-alone operation to an integrated part of a sophisticated power architecture. For maximum flexibility, internal fusing is not included; however, to achieve maximum safety and system protection, always use an input line fuse. The safety agencies require a slow-blow fuse with maximum rating of 6.3 A. Based on the information provided in this data sheet on inrush energy and maximum DC input current, the same type of fuse with lower rating can be used. Refer to the fuse manufacturer's data for further information.

Minimum Load Requirement

10%(of full load) minimum load required. The 10% minimum load requirement is in order to meet all performance specifications. The PXD15-xxSxx series does not properly maintain regulation and operate under a no- load condition. The output voltage drops off about 10%.

MTBF and Reliability

The MTBF of PXD15-xxSxx series of DC/DC converters has been calculated using

1.MIL-HDBK-217F under the following conditions:

Nominal Input Voltage

$I_o = I_o, \max$

$T_a = 25^\circ\text{C}$

The resulting figure for MTBF is 1.044×10^6 hours.

2.Bell-core TR-NWT-000332 Case I:

50% stress, Operating Temperature at 40°C (Ground fixed and controlled environment)

The resulting figure for MTBF is 2.041×10^6 hours.