



ESSENTIAL INFORMATION

BUILD INSTRUCTIONS
CHECKING YOUR PCB & FAULT-FINDING
MECHANICAL DETAILS
HOW THE KIT WORKS

ADD AN AUDIO MESSAGE TO YOUR PRODUCT WITH THIS

RECORD & PLAYBACK KIT

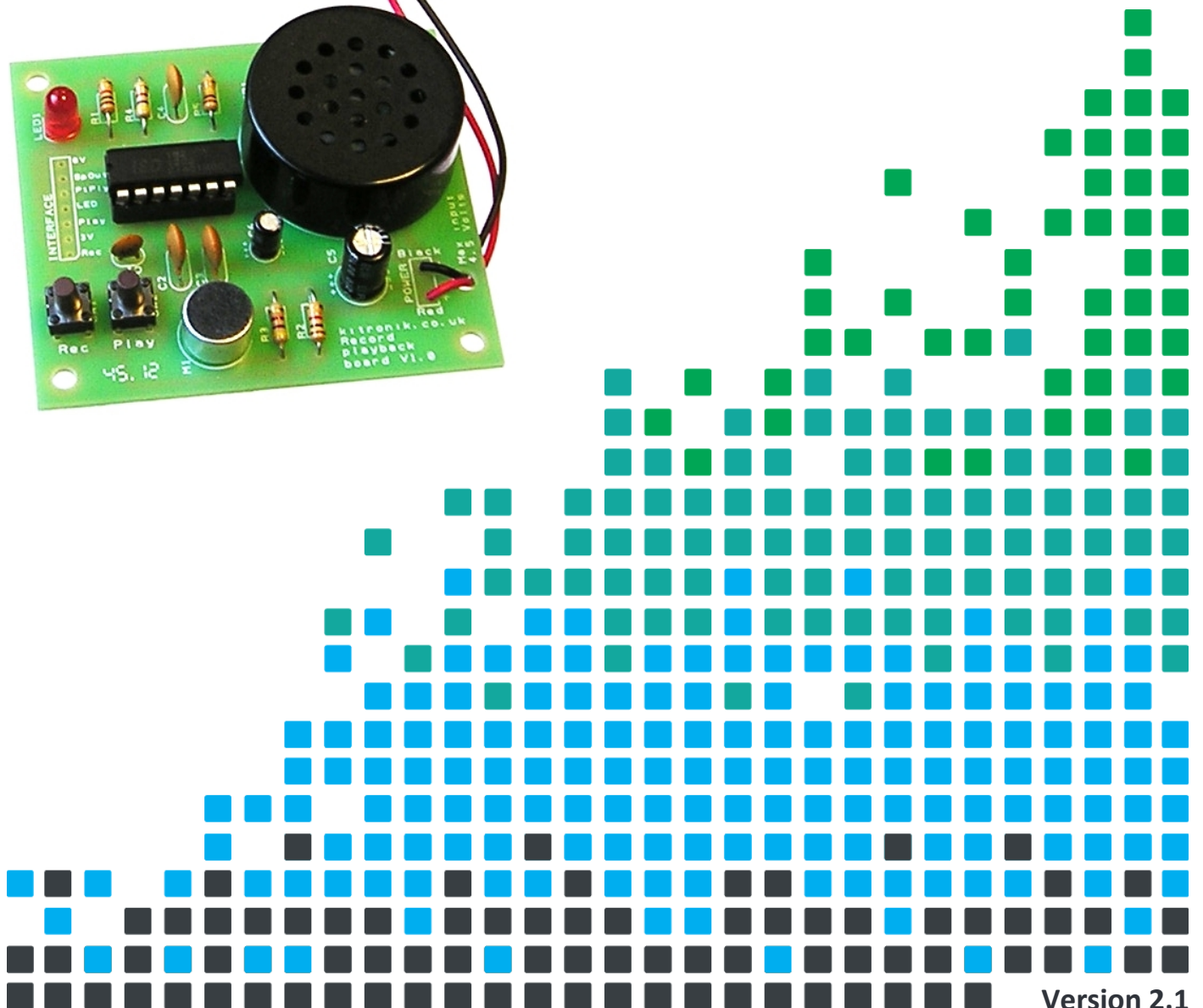
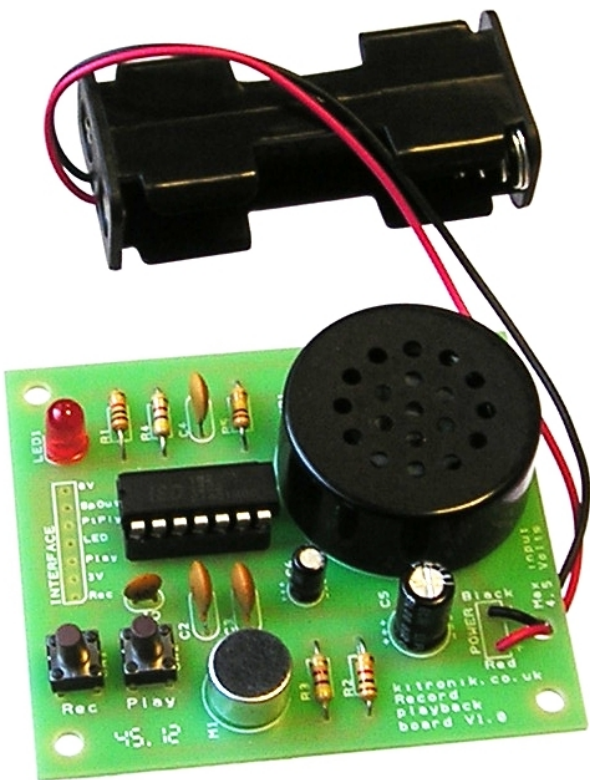

Build Instructions

Before you start, take a look at the Printed Circuit Board (PCB). The components go in the side with the writing on and the solder goes on the side with the tracks and silver pads.

1 PLACE RESISTORS

Start with the five resistors:
The text on the PCB shows where R1, R2 etc go.
Ensure that you put the resistors in the right place.

| PCB Ref | Value | Colour Bands |
|---------|-------|----------------------|
| R1&R2 | 1K | Brown, black, red |
| R3&R4 | 4.7K | Yellow, purple, red |
| R5 | 100K | Brown, black, yellow |

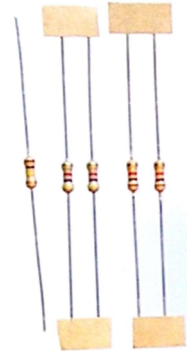

2 SOLDER THE IC HOLDER

Solder the Integrated Circuit (IC) holder into IC1. When putting it into the board, be sure to get it the right way around. The notch on the IC holder should line up with the notch on the outline marked on the PCB.



3 SOLDER THE MICROPHONE

The microphone should be soldered into the board where it is marked M1. The microphone is polarized (the two pins are off centre). For it to work the part must go inside the circle marked on the PCB.



4 SOLDER THE CERAMIC DISC CAPACITORS

The four ceramic disc capacitors should be soldered into the board as follows:
C1 = 1nF marked 102
C2 – C4 = 100nF marked 104



5 SOLDER THE CERAMIC DISC CAPACITORS

Now solder in the two electrolytic capacitors. Make sure that the capacitors are the correct way around. The capacitors have a '-' sign marked on them, which should match the same sign on the PCB. The capacitors have text printed on the side that indicates their value. The capacitors are placed as:
C5 = 220µF
C6 = 4.7µF



6 SOLDER THE LED

The Light Emitting Diode (LED) should be soldered into the board where it is marked LED1. The LED won't work if it doesn't go in the right way around. If you look carefully one side of the LED has a flat edge, which must line up with the flat edge on the outline on the PCB. Once you are sure that it is in the right way around, solder it in place.



7 SOLDER THE SWITCHES

Solder the two switches into the board where it is labelled SW1 & SW2. Once you have got the pins lined up with the holes they can be pushed firmly into place and then soldered.



8 SOLDER THE SPEAKER

The speaker should be soldered into the board where it is labelled SP1. Whilst the board and the speaker may have a '+' indication on them, it doesn't actually matter which way around the speaker goes.



9 ATTACH THE BATTERY CAGE

The two times AA battery cage should be attached to the terminals labelled 'POWER'. Feed the wires through the strain relief hole from the bottom of the board then connect the red wire to '+' and the black wire to '-' and solder in place.

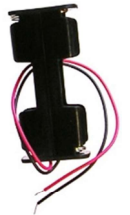

10 INSERT THE IC INTO HOLDER

The IC can now be placed into the IC holder. When doing this, make sure that the notch on the IC lines up with the notch on the IC holder.



Checking Your Record Playback PCB

Carefully check the following before you insert the batteries:

Check the bottom of the board to ensure that:

- All holes (except the 4 large (3mm) holes in the corners and the interface connections) are filled with the lead of a component.
- All the leads are soldered.
- Pins next to each other are not soldered together.

Check the top of the board to ensure that:

- The '-' on the electrolytic capacitors match the same marks on the PCB.
- The colour bands on R1 & R2 are brown, black, red.
- The colour bands on R5 is brown, black, yellow.
- The LED matches the outline on the PCB.
- The battery clip red and black wires match the red and black text on the PCB.
- The notch on the IC is next to the interface connections.



Fault finding flow chart page 1

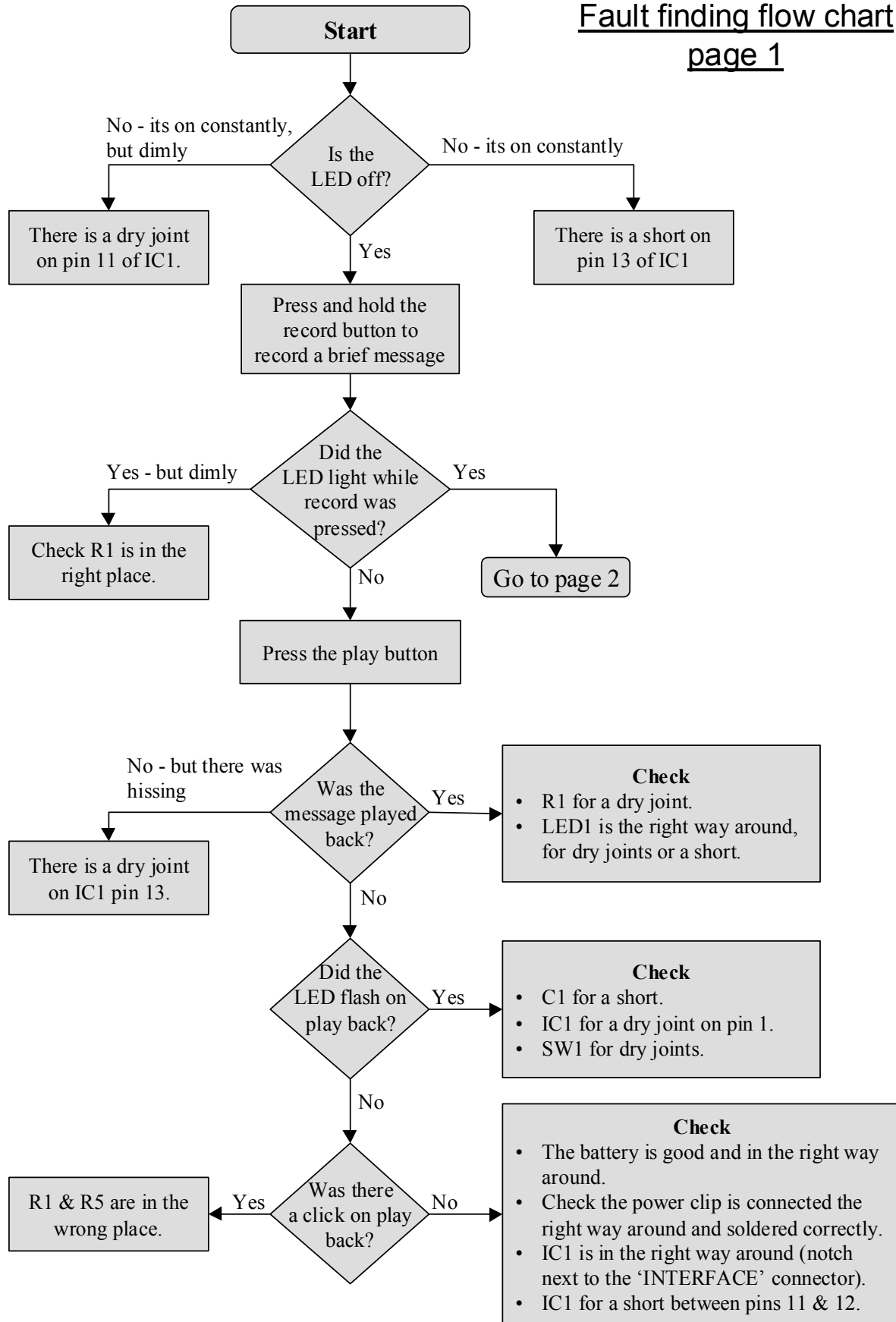

Fault finding flow chart page 2

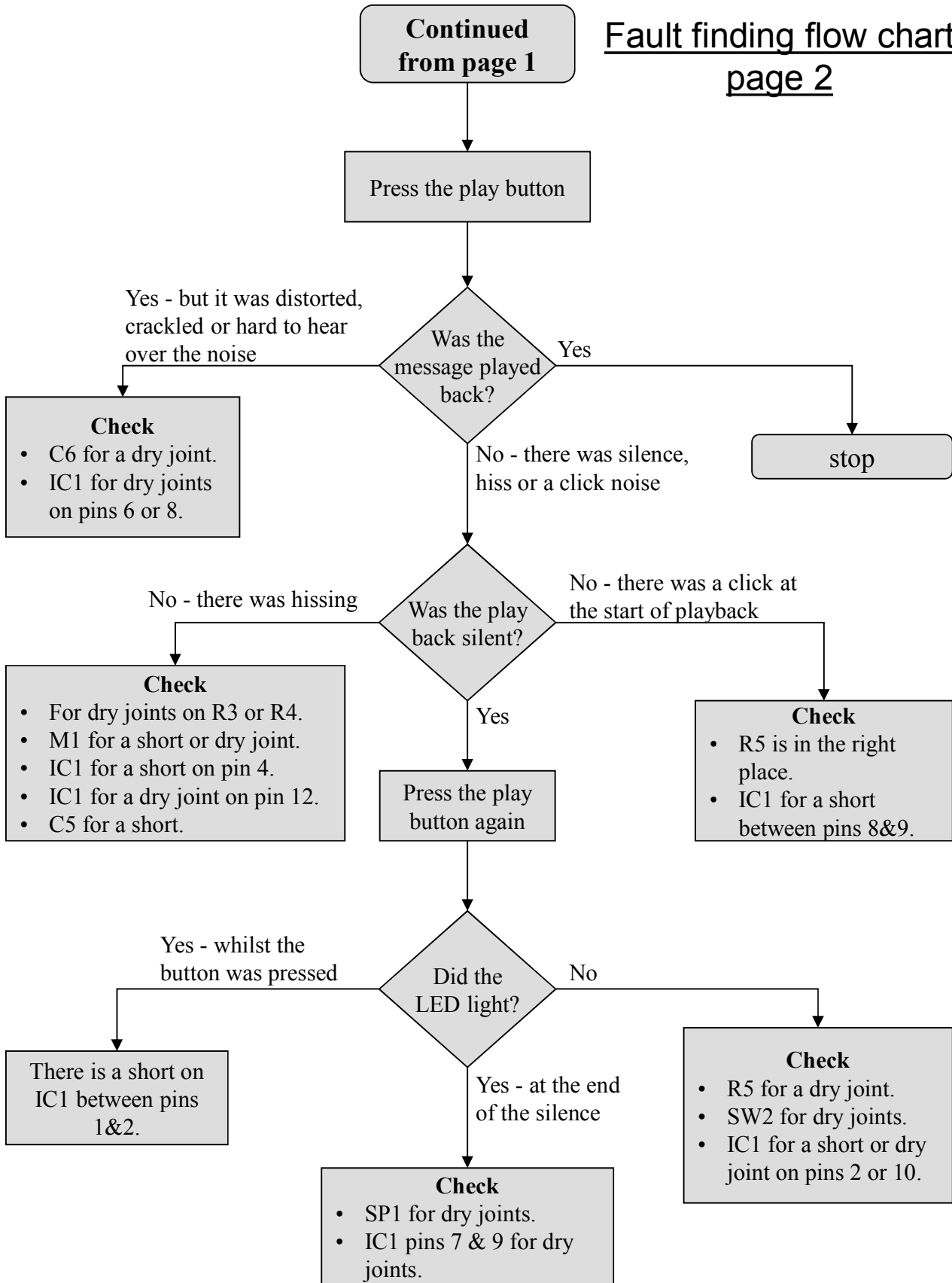

Adding a Flashing 'Memo Recorded' LED

It is possible to use your Record Playback module as a memo, when doing this you might want to add a flashing LED to indicate that there is a recorded memo that should be played back. The kit doesn't include the parts to do this, however you only need a flashing LED and a slide or toggle switch to do this. The board includes an interface connector and this will be used to connect the LED and the switch to the batteries. The flashing LED is designed to run from a 5V supply and will work at 3V and doesn't need a current limit resistor. The diagram below shows how to make the connections:

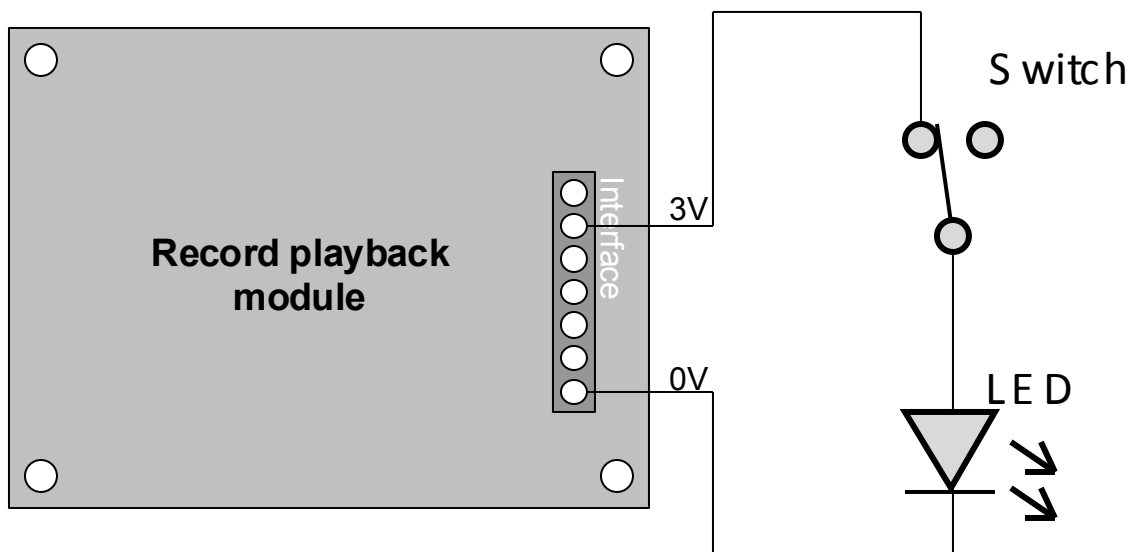

When connecting the LED make sure that the flat edge / short lead is connected to the 0V connection on the interface connector. The switch should be connected to the 3V connection.

Suggested LEDs

- 3538 – 5mm flashing red
- 3539 – 5mm flashing green
- 3540 – 5mm flashing yellow
- 3545 – 5mm flashing blue

Suggested switches

- Slide switches – standard 3416, miniature 3404
- Rocker switches – rectangular 3406, round 3407
- Toggle switches – standard 3408, miniature 3413



Designing the Enclosure

When you design the enclosure, you will need to consider:

- The size of the PCB (below, height including components = 16.5mm)
- How big the battery holder is.

These technical drawings should help you to plan this.
All dimensions are in mm.

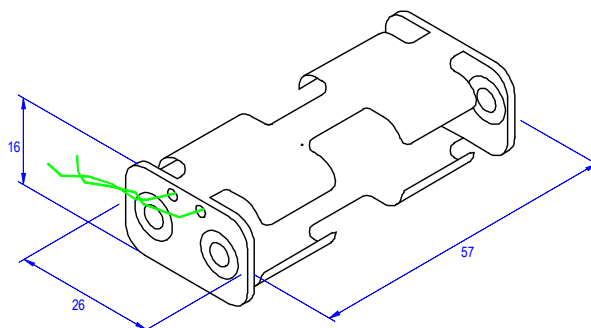
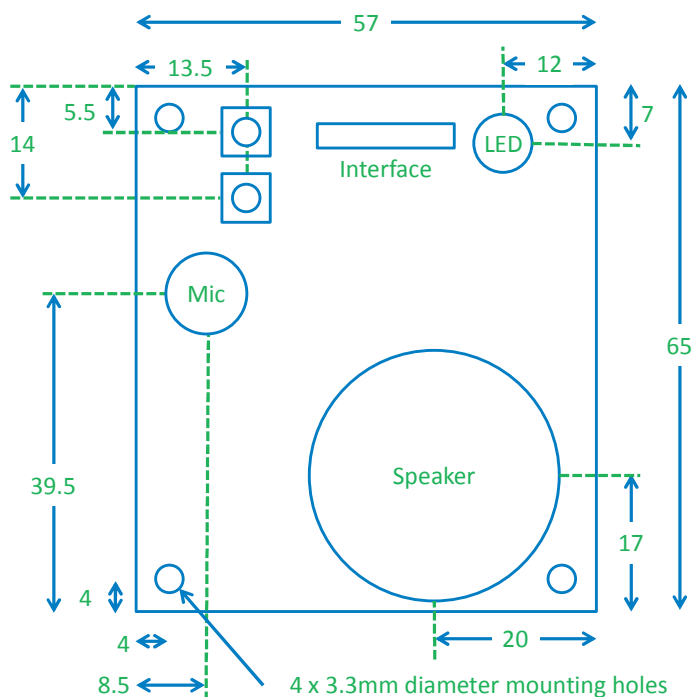

| | |
|---|--|
| <p>P.C.B. SPACER ENCLOSURE 2 X M3 BOLTS</p> | <p>Mounting the PCB to the enclosure</p> <p>The drawing to the left shows how a hex spacer can be used with two bolts to fix the PCB to the enclosure.</p> <p><i>Your PCB has four mounting holes designed to take M3 bolts</i></p> |
|---|--|



How the Record Playback Module Works

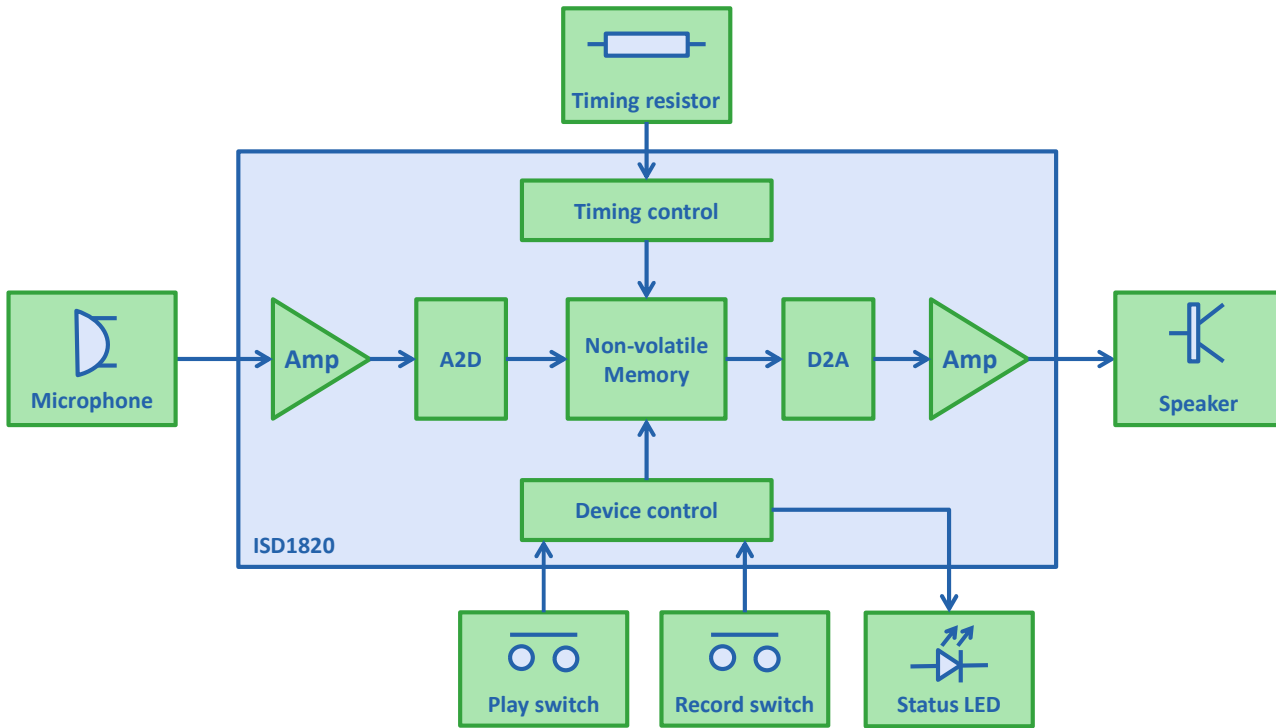

The main component in the circuit is the ISD1820, which is a Record Playback IC. This is the main boxed section in the block diagram above. During the record phase, the chip amplifies the signal from the microphone and digitizes this allowing the recording to be stored in memory. This memory is non-volatile, which means that the information is retained even when the power is removed. During playback the data is taken out of the memory, converted back from a digital signal into an analogue signal which is then amplified before it is output to the speaker.

The timing control section of the chip uses a resistor / capacitor network to set how fast the data is stored or retrieved from the on board memory. The timing resistor (R5) along with an internal capacitor sets the record / playback time to 10 seconds. This can be adjusted from 8 seconds to 16 seconds, however the longer the record time the worse the quality of the audio as the sample rate is reduced.

The device control block checks the state of both the play switch and the record switch and either plays back the current message or records a new message.

The device control block also turns the LED on to show that recording is in progress or that playback has finished. When neither record nor playback is in progress the device control block puts the whole unit into sleep where it takes virtually no current, thus allowing the battery to remain connected when the device is not in use.

The switches SW1 & SW2 are connected to the positive supply and the IC. There are internal pull down resistors for both inputs inside the IC. A 1nF capacitor (C1) is present on the record line to remove any switch bounce that could cause a brief re-record to take place as the switch is released at the end of recording. The status LED requires a current limit resistor (R1) and there is a 100nF capacitor (C4) connected across the power supply to make sure it is smooth. All the remaining resistors and capacitors are used to power the microphone and filter the audio from it.



Record Playback IC Pins on the ISD1820

The following table indicates what each pin on the Record Playback IC does:

| Pin No | Name | Description |
|--------|---------|--|
| 1 | REC | The record input: when taken and held high causes the device to re-record the message. The IC contains a pull down resistor on this input. |
| 2 | PLAYE | The play (edge activated) input: when taken from low to high, the device plays back the full message. The IC contains a pull down resistor on this input. |
| 3 | PLAYL | The play (level activated) input: when held high, the device plays back the message, if taken low during playback, playback stops immediately. The IC contains a pull down resistor on this input. |
| 4 | MIC | Microphone input. The microphone is AC coupled to this pin via a series capacitor. The IC contains amplification, so external amplification is not required. |
| 5 | MIC REF | Microphone reference: the negative microphone connection, used to reduce noise. This is also AC coupled through a series capacitor. |
| 6 | AGC | Automatic gain control: used to set the gain of the pre-amp. Connecting a 4.7uF capacitor between the AGC pin and Gnd, gives good all round performance. |
| 7 | SP- | Speaker out-: the negative speaker output signal, min impedance 8 ohms. |
| 8 | Gnd | Ground: the zero volts connection. |
| 9 | SP+ | Speaker out+: the positive speaker output signal, min impedance 8 ohms. |
| 10 | Rosc | Resistor oscillator: the resistor that sets the oscillator speed. Connected between Rosc and Gnd. Rosc = 80K gives 8 seconds (min record time), Rosc = 160K gives 16 seconds (max record time) |
| 11 | Vcc | The positive voltage connection, typically 3V but will operate from 2.7V to 4.5V. |
| 12 | FT | Feed through: this pin is held in a low state by an internal pull down resistor in normal operation. However can be taken high if the pre-amp stage needs to be bypassed. In this case the input signal is feed through directly to the analogue to digital converter. |
| 13 | RECLEd | Record LED: this output is normally high and goes low during record for the duration of the recording. It also goes low upon completion of playback and can be used to make the IC continually replay the message. |
| 14 | Gnd | Ground: the zero volts connection. |



Using the Interface Connector

The interface connector allows some of the more advanced options of the IC to be accessed. It can be used to connect off board switches for Record & Playback and gives access to the pins to play part of a message or use the looped play option. The status LED is output to the connector, as is the audio output signal, which can be used with a more powerful amplifier if required. The following table explains what the seven pins on the interface connector do, along with example connections at the bottom of the page.

| Name | Description |
|-------|--|
| Rec | Record: connect a push button switch between this pin and the 3V pin to re-record a message when the button is pressed. The pin can be connected to a micro controller, when it should normally be in a low state and taken high to record. |
| 3V | The 3V: positive connection from the batteries. |
| Play | Play: connect a push button switch between this pin and the 3V pin to playback the full message when the button is pressed. The pin can be connected to a micro controller, when it should normally be in a low state and briefly taken high to initiate the playback. |
| LED | LED out can be used to connect an external LED. The LED should be connected between 3V and the LED pin (a current limit resistor may be required). The pin can also be used as an input to a micro controller to determine when the device is full during record or to know when playback has finished. The pin is normally high, going low during record and briefly upon completion of playback. |
| PtPly | The part play pin can be used to play the message from the beginning until the button is released. To do this a switch should be connected between the part play pin and the 3V connection. If being driven from a micro-controller, the signal should be normally low going high when playback is required. |
| SpOut | Speaker out can be used to connect the audio out to a more powerful amplifier, when the speaker out pin connects to the amplifier boards audio in. The Record Playback board and the amplifier board must have a common 0V connection. |
| 0V | 0V is the negative connection from the batteries. |

| | |
|--|---|
| <p>Adding an additional off board switch to record & playback a message.</p> | <p>Adding an off board switch to part playback the message.</p> |
| <p>Adding an off board switch to continuously loop the message.</p> | <p>Connecting the board to a higher power amplifier.</p> |



Online Information

Two sets of information can be downloaded from the product page where the kit can also be reordered from. The 'Essential Information' contains all of the information that you need to get started with the kit and the 'Teaching Resources' contains more information on soldering, components used in the kit, educational schemes of work and so on and also includes the essentials. Download from:

www.kitronik.co.uk/2149



This kit is designed and manufactured in the UK by Kitronik

Telephone: +44 (0) 845 8380781

Sales email: sales@kitronik.co.uk

Tech support email: support@kitronik.co.uk

Web: www.kitronik.co.uk



www.kitronik.co.uk/twitter



www.kitronik.co.uk/facebook



www.kitronik.co.uk/youtube



www.kitronik.co.uk/google

Every effort has been made to ensure that these notes are correct, however Kitronik accept no responsibility for issues arising from errors / omissions in the notes.

© Kitronik Ltd - Any unauthorised copying / duplication of this booklet or part thereof for purposes except for use with Kitronik project kits is not allowed without Kitronik's prior consent.

