

DATE	REV	ECN	APP'D. BY
10-31-05	A4	7360	TRM
1-13-06	A5	7437	JM
10-20-08	A6	8574	TJA

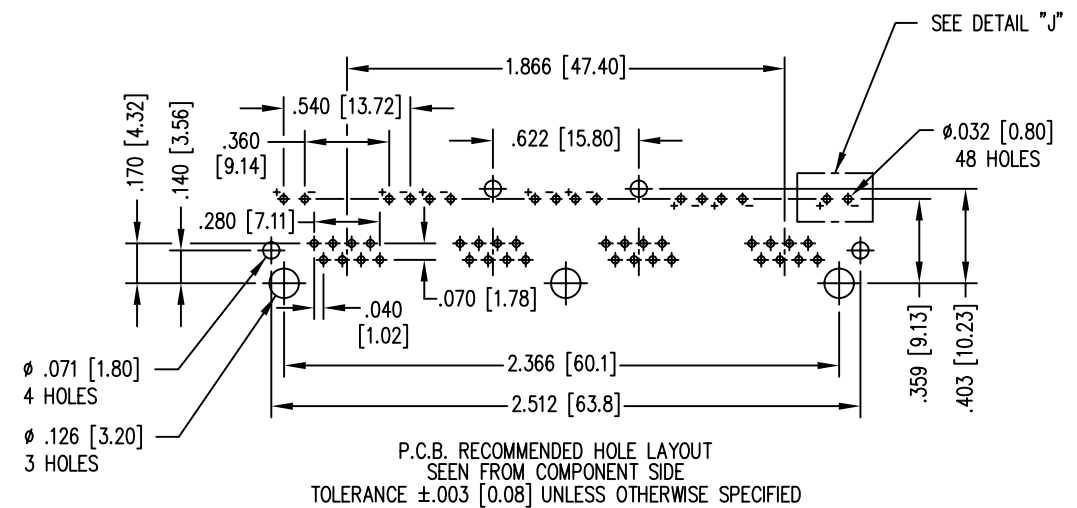

NOTES:

- CONNECTOR MATERIALS:
 HOUSING: PBT+30%G.F. UL94V-0. STANDARD COLOR: BLACK
 INSERT: PBT+30%G.F. UL94V-0. STANDARD COLOR: BLACK
 LENS: PC UL94V-0. STANDARD COLOR: CLEAR
 BACK: PBT+30%G.F. STANDARD COLOR: BLACK
 LED 3.2 x 2.0 x 4.0 x P=2.29mm.
 SHIELD: COPPER ALLOY 0.25mm THICKNESS.
 CONTACT: 0.35mm (.014") THICKNESS GOLD PLATING OVER NICKEL PHOSPHOR BRONZE ALLOY SELECTIVE.
- FOR PRODUCT SPECIFICATION SEE PR022-01

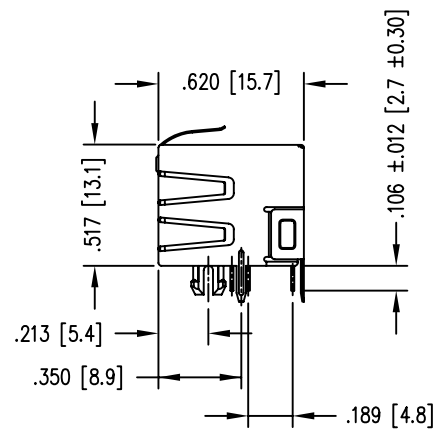
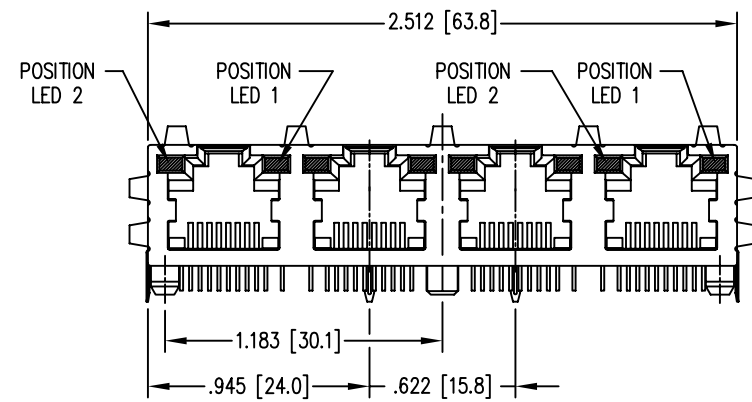
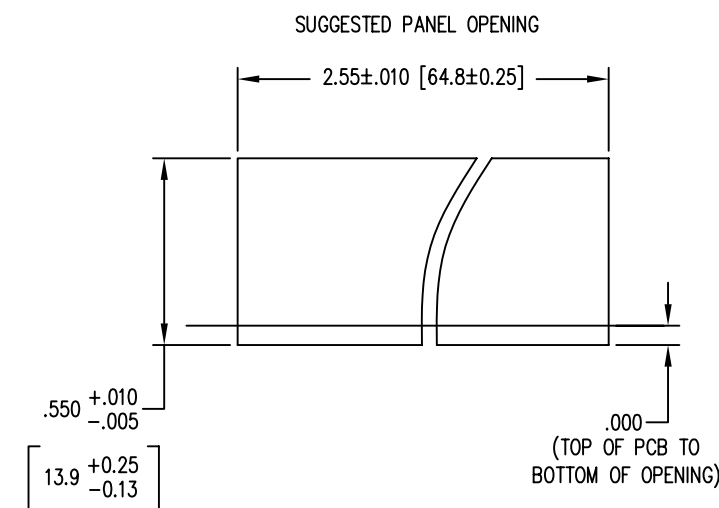

GREEN	RED	SS-74404-004
GREEN	YELLOW	SS-74404-002
POSITION 2	POSITION 1	PART NUMBER
INDICATOR COLOR		

LED POLARITY
(ENLARGED VIEW)

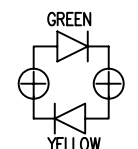

BI-COLOR LED
DETAIL "J"
TYP. (8)

LED POLARITY
(ENLARGED VIEW)

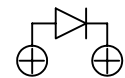

SINGLE COLOR LED
DETAIL "J"
TYP. (8)



THIRD ANGLE PROJECTION

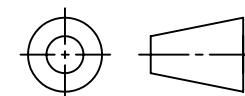

DO NOT SCALE DRAWING
DRAWING IS SUBJECT TO
CHANGE WITHOUT NOTICE

DIMENSIONS: INCHES [METRIC]

UNLESS OTHERWISE SPECIFIED
TOLERANCES ARE ±.005 [0.13]
ANGLES ARE ± 1°

SHEET NO.
1 OF 1

Bel Stewart Connector

11118 Susquehanna Trail South
Glen Rock, PA 17327-9199
(717) 235-7512 Fax: (717) 235-7954 <http://www.stewartconnector.com>

TITLE: 4 PORT PCB HARMONICA LED JACK PAC
EMI-RFI ONE PIECE SHIELDED, ESD GROUNDING

THIS DRAWING AND THE SUBJECT MATTER SHOWN THEREON ARE CONFIDENTIAL AND THE PROPRIETARY PROPERTY OF BEL STEWART CONNECTOR AND SHALL NOT BE REPRODUCED, COPIED, OR USED IN ANY MANNER WITHOUT PRIOR WRITTEN CONSENT OF BEL STEWART CONNECTOR. THE SUBJECT MATTER MAY BE PATENTED OR A PATENT MAY BE PENDING.

DRN BY:	TRM	DATE	9-24-01
APPD BY:	RGC	DATE	9-25-01
DWG NO.	CT740082	REV.	A6