

Waterproof Connectors for Outdoor Use

HR41A Series



■ Features

1. Waterproof connector designed for outdoor use

Light-weight and waterproof, these connectors are well suited for outdoor use applications. The highly weather resistant plastic shell material is compliant with UL Certification : UL746C f1 Class.

2. Waterproof structure

Supports IP67 and IP68 ratings while in the mated condition. (Rating explained below*)

*IP67 : Submerged in 1m for 30 minutes

*IP68 : Submerged in 2m for 14 days

3. Easy-to-operate push-on bayonet lock

The push-on bayonet lock quickly achieves complete locking in a single action. (Fig.2)

4. Easy field assembly

User-friendly operations and assembly allow this connector to be wired in the field.

5. Sequential Contact

Contacts are sequentially arranged to create a "first mate-last break" type of condition.

6. Designed to accommodate hot swapping

Hot swapping condition :
This testing method conforms to UL1977 standards.

7. Surge resistant

The walled structure isolates each contact and provides enough insulation to protect against 15kV surges caused by lightning.

8. Safety standard certified

The HR41A is certified under the UL1977 specifications.

◆ Mated condition diagram

Nut-tightening rear mount type (panel thickness=2mm)

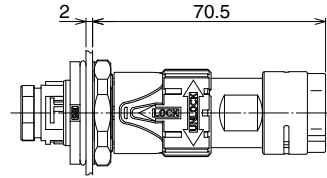

Screw-fastening type with flange

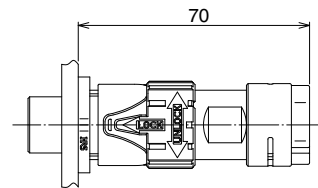

Fig.1

◆ Locking structure (Push-on bayonet)

Mating : Push the plug straight on to the receptacle.



Un-mating : Simply twist and remove the plug

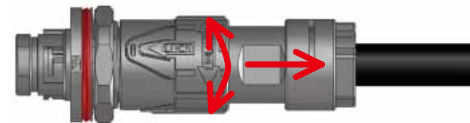

1. Rotate locking collar 2. Remove rear-ward.
in either direction

Fig.2

Product Specifications

Ratings	Current Rating (Note 3)	13A (Ambient Temperature 25°C)	Operating Temperature Range	-40 to +105°C (Note 1)
	Voltage Rating	AC 1000V, DC 1000V	Storage Temperature Range	-10 to +60°C
UL, TÜV	Current Rating (Note3)	10A	Operating Temperature Range	-40 to +105°C (Note1)
	Voltage Rating	AC 600V, DC 600V	Storage Temperature Range	-10 to +60°C

Note 1 : Including temperature rise due to current carrying.

Items	Specifications	Conditions
1. Contact resistance	5mΩ or less	Measured at 1A, DC
2. Insulation resistance	A minimum of 5,000MΩ	Measured at 500V, DC
3. Withstand voltage	No flashover or breakdown	2,200V AC for one minute
4. Vibration resistance	No electrical interruption of 10μs or more	Frequency : 10 to 55 to 10Hz/cycle Half amplitude 0.75mm, 5 minutes/cycle 10 cycles each in 3 axis directions
5. Shock resistance	No electrical interruption of 10μs or more	Acceleration : 490m/s ² , duration : 11ms, 3 times each in 3 axis directions
6. Durability	Contact resistance : up to 10mΩ	500 times
7. Temperature cycle	Insulation resistance : 500MΩ or higher	-40°C for 30 minutes → At normal temperature for 2 to 3 minutes → +105°C for 30 minutes → At normal temperature for 2 to 3 minutes. Repeated for 5 cycles.
8. Moisture resistance (Steady state)	Insulation resistance : 50MΩ or higher (in a high humidity environment) 500MΩ or higher (in a dry environment)	Temperature : 40°C, relative humidity : 90 to 95%, left for 96 hours
9. Water resistance	No water intrusion into the connector	Left submerged in water in mated condition at depth of 2m for 14 days.

Depending on the structure and use of the cable, cable clamping force and cable stress, the waterproof performance may differ from what is noted above. Please check the performance before using the connector.

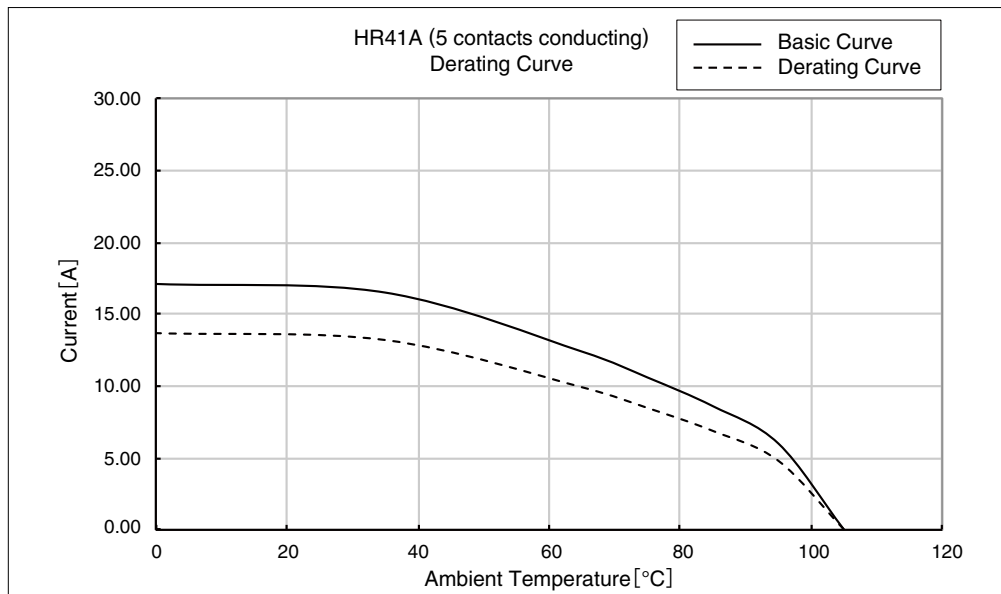

Note 2 : The derating curve is derived from the basic curve multiplied by the derating factor of 0.8.

Note 3 : The value of rated current varies with the ambient temperature. It is recommended to use the product within the derating curve zone.

When using a UL or TÜV approved product, please use the product within the specified range as well as the derating curve area.

Note 4 : The measurement method of the derating curve is shown below.

- Test specimen : This product, unused prior to testing.
- Test cable conductor cross sectional area : 16AWG (1.31mm²)
- Test condition : Power supplied while the specimen is in a stationary state and then measured.

Materials / Finish

Component	Materials	Finish	UL standard (noncombustible)
Insulator	Polyamide resin, PBT resin	—————	UL94V-0
Contact	Copper alloy	Partially gold plated	—————
O-ring, gasket	Silicone rubber	—————	—————

Product Number Structure

Refer to the chart below when determining the product specifications from the product number.
Please select from the product numbers listed in this catalog when placing orders.

Connector

HR41A - 17 W B P A - 5 S C ()**

①
②
③
④
⑤
⑥
⑦
⑧
⑨
⑩

Crimp contact

HR41A - S C - 1 1 1 ()**

①
⑧
⑨
⑪
⑪
⑬
⑩

① Series Name	: HR41A	⑧ Shape of contact	S : Female contact P : Male contact
② Shell size	: 17	⑨ Contact wiring type	C : Crimp
③ Specialty	W : Waterproof type	⑩ Additional product specifications will be identified by the addition of (01), (02)...etc. as needed.	
④ Lock mechanism	B : Bayonet lock	⑪ Form of the contact	1 : Loose piece contacts 2 : Contacts on reels
⑤ Shell type	P : Plug R : Receptacle J : Jack	⑫ Shape 1	: Denotes the compatible wire gauge and will be identified by the use of 1, 2, 3 etc.
⑥ Serial symbol		⑬ Plating of the contact area	1 : Gold plated
⑦ Number of contact	: 3 or 5		

Diagram of Connector Mating Combinations

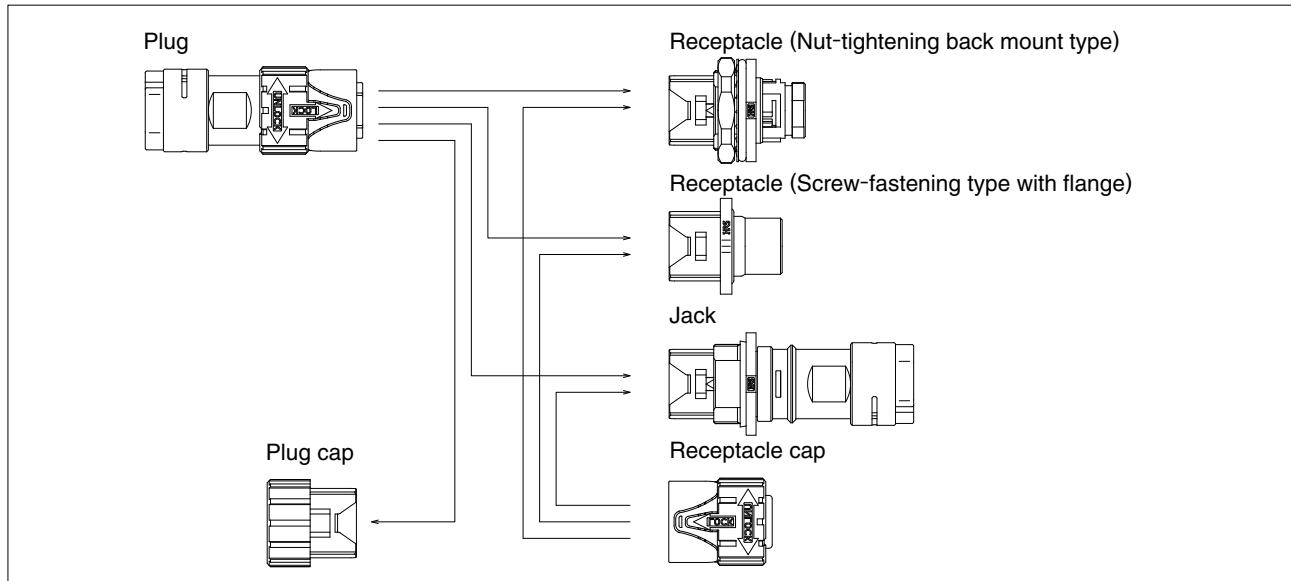

Connector

Plug	Receptacle	Jack
HR41A-17WBPA-5SC	HR41A-17WBRA-5PC HR41A-17WBRB-5PC	HR41A-17WBJ-5PC
HR41A-17WPAB-5SC		HR41A-17WBJB-5PC
HR41A-17WPAD-5SC		HR41A-17WBJD-5PC
HR41A-17WPAPAE-5SC		HR41A-17WBJF-5PC
HR41A-17WPAPAF-5SC		
HR41A-17WBP-3PC	HR41A-17WBRA-3SC	—

Plug cap

Plug	Cap
HR41A-17WBPA-5SC	HR41A-17WBP-C
HR41A-17WPAB-5SC	
HR41A-17WPAD-5SC	
HR41A-17WPAPAE-5SC	
HR41A-17WPAPAF-5SC	
HR41A-17WBP-3PC	

Receptacle/Jack cap

Receptacle/jack	Cap
HR41A-17WBRA-5PC	HR41A-17WBR-C
HR41A-17WBRB-5PC	
HR41A-17WBRA-3SC	
HR41A-17WBJ-5PC	
HR41A-17WBJB-5PC	
HR41A-17WBJD-5PC	
HR41A-17WBJF-5PC	

■ Plug

● 5-position type

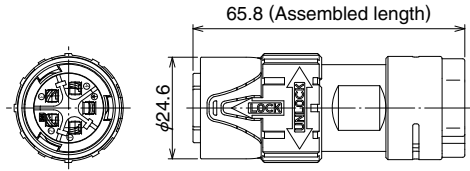

Part No.	HRS No.	No. of contacts	Applicable cable diameter	Remarks
HR41A-17WBPA-5SC	141-0203-1	5	10.7 to 11.5	Sequential mating
HR41A-17WPAB-5SC	141-0210-7		9.0 to 9.8	
HR41A-17WBPAD-5SC	141-0226-7		8.2 to 9.0	
HR41A-17WPAAE-5SC	141-0223-9		7.4 to 8.2	
HR41A-17WBPAPF-5SC	141-0228-0		9.9 to 10.7	

※Please refer to the specification for the details of sequential mating structure.

● 3-position type

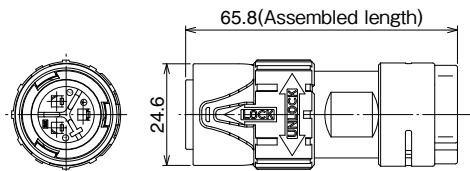

Part No.	HRS No.	No. of contacts	Applicable cable diameter	Remarks
HR41A-17WBP-3PC	141-0217-6	3	10.7 to 11.5	—

■ Receptacle

● Nut-tightening rear mount type (5-position)

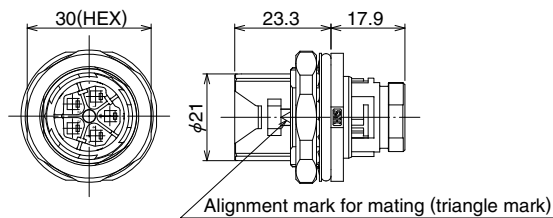

Part No.	HRS No.	No. of contacts	Remarks
HR41A-17WBRA-5PC	141-0201-0	5	—

● Nut-tightening back mount type (3-position)

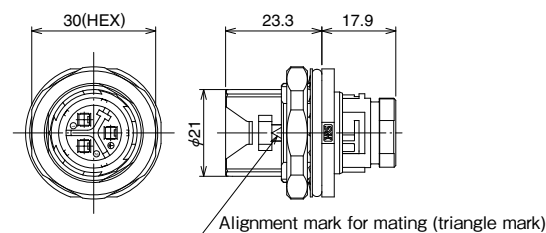

Part No.	HRS No.	No. of contacts	Remarks
HR41A-17WBRA-3SC	141-0218-9	3	Sequence structure

※Please refer to the specification for the details of sequential mating structure.

● Screw-fastening type (5-position)

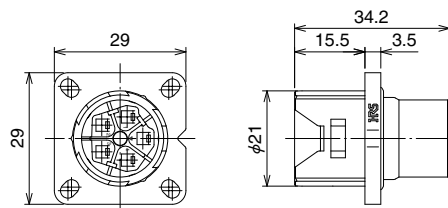

Part No.	HRS No.	No. of contacts	Remarks
HR41A-17WBRB-5PC	141-0222-6	5	—

■ Jack

● 5-position type

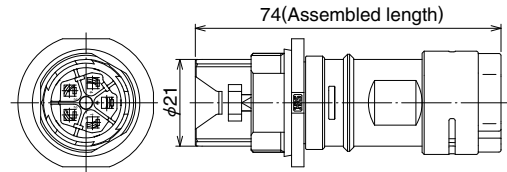

Part No.	HRS No.	No. of contacts	Applicable cable diameter
HR41A-17WBJ-5PC	141-0202-9	5	10.7 to 11.5
HR41A-17WBJB-5PC	141-0212-2		9.0 to 9.8
HR41A-17WBJD-5PC	141-0216-3		8.2 to 9.0
HR41A-17WBJF-5PC	141-0229-5		9.9 to 10.7

■ Caps

● Plug

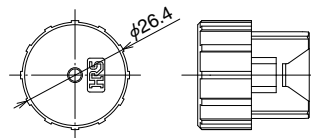

Part No.	HRS No.	Applicable Connectors
HR41A-17WBP-C	141-0219-0	HR41A-17WBPA-5SC HR41A-17WBPA B-5SC HR41A-17WBPA D-5SC HR41A-17WBPA E-5SC HR41A-17WBPA F-5SC HR41A-17WBP-3PC

● Receptacle/ Jack

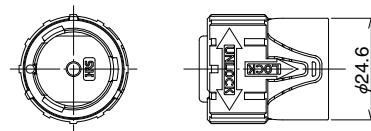

Part No.	HRS No.	Applicable Connectors
HR41A-17WBR-C	141-0220-0	HR41A-17WBRA-5PC HR41A-17WBRB-5PC HR41A-17WBRA-3SC HR41A-17WBJ-5PC HR41A-17WBJB-5PC HR41A-17WBJD-5PC HR41A-17WBJF-5PC

Apr.1.2017 Copyright 2017 HIROSE ELECTRIC CO., LTD. All Rights Reserved.

◆ Crimp contacts

● Female contact

Gold plated specification

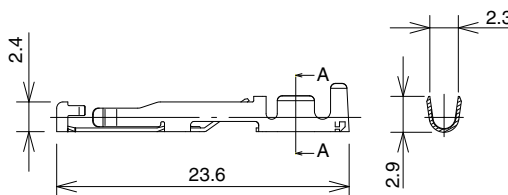

Type	Part No.	HRS No.	Contact plating thickness (terminal is only plated on interface portion)	Applicable wire size	Remarks
Loose pcs contacts	HR41A-SC-111	141-0213-5	Gold : 0.76μm	16 to 20 AWG	100 pcs/pack
	HR41A-SC-111(01)	141-0213-5 01	Gold : 0.2μm		
Reel contacts	HR41A-SC-211	141-0206-0	Gold : 0.76μm	0.52 to 1.31mm ²	5,000 pcs/reel
	HR41A-SC-211(01)	141-0206-0 01	Gold : 0.2μm		

※A wire insulation diameter of φ1.9mm to 3.2mm cables needs to be used.

Silver plated specification

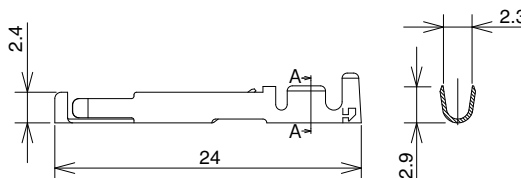

Type	Part No.	HRS No.	Contact plating thickness (terminal is only plated on interface portion)	Applicable wire size	Remarks
Loose contact	JRC-SC-112	114-0241-8	Silver : 5μm	16 to 20 AWG	100 pcs/pack
Reel contact	JRC-SC-212	114-0242-0		0.52 to 1.31mm ²	5,000 pcs/reel

※A wire insulation diameter of φ1.9mm to 3.2mm cables needs to be used.

● Male contact

Gold plated specification

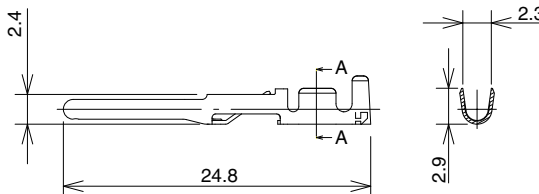
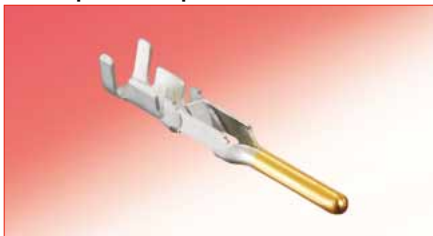

Type	Part No.	HRS No.	Contact plating thickness (terminal is only plated on interface portion)	Applicable wire size	Remarks
Loose pcs contacts	HR41A-PC-111	141-0214-8	Gold : 0.76μm	16 to 20 AWG	100 pcs/pack
	HR41A-PC-111(01)	141-0214-8 01	Gold : 0.2μm		
Reel contacts	HR41A-PC-211	141-0207-2	Gold : 0.76μm	0.52 to 1.31mm ²	5,000 pcs/reel
	HR41A-PC-211(01)	141-0207-2 01	Gold : 0.2μm		

※A wire insulation diameter of φ1.9mm to 3.2mm cables needs to be used.

Silver plated specification

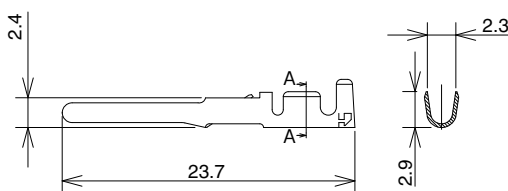

Type	Part No.	HRS No.	Contact plating thickness (terminal is only plated on interface portion)	Applicable wire size	Remarks
Loose contact	JRC-PC-112	114-0239-6	Silver : 5μm	16 to 20 AWG	100 pcs/pack
Reel contact	JRC-PC-212	114-0240-5		0.52 to 1.31mm ²	5,000 pcs/reel

※A wire insulation diameter of φ1.9mm to 3.2mm cables needs to be used.

◆ Applicable tools

Type	Items	Part No.	HRS No.	Applicable contacts	Applicable wire size
Manual	Manual crimping tool	HT802/HR41A-11-16	150-0408-5	HR41A-SC-111	16 AWG
		HT802/HR41A-11-18	150-0404-4	HR41A-PC-111	18 AWG
		HT802/HR41A-11-20	150-0407-2		20 AWG
		JRC-TC-11	150-0033-4	JRC-PC-112 JRC-SC-112	16 AWG
		JRC-TC-12	150-0034-7	JRC-PC-112 JRC-SC-112	18 to 20 AWG
Automatic	Automatic crimping press	CM-105C	901-0001-0		
	Applicator for press	AP105-HR41A-1	901-2055-3	HR41A-SC-211 HR41A-PC-211	16 to 20 AWG
		AP105-JRC-1	901-2039-7	JRC-PC-212 JRC-SC-212	
Extraction tool		HR41A-TP	150-0405-7	HR41A-SC-111 HR41A-PC-111 HR41A-SC-211 HR41A-PC-211	
		JRC-TP	150-0035-0	JRC-SC-112 JRC-SC-212 JRC-PC-112 JRC-PC-212	

● Manual crimping tool
HT802/HR41A-11



● Automatic crimping press, model
CM-105C (applicator sold separately)



● Extraction tool
HR41A-TP



● Hand tool crimp
JRC-TC-11 JRC-TC-12

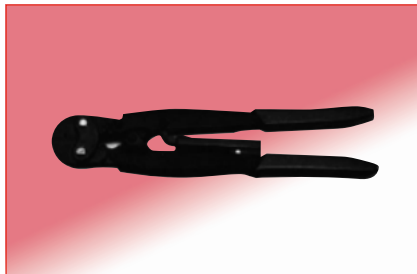

● Extraction tool
JRC-TP

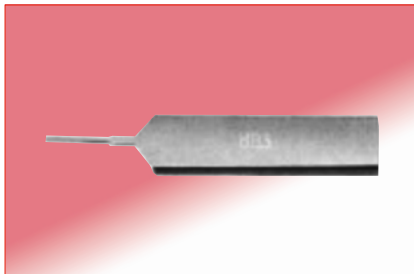

◆ Panel mounting hole dimensions

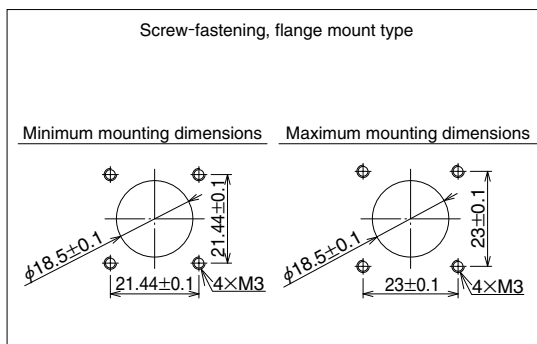
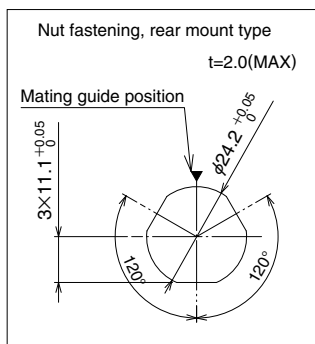

◆ Precautions for using connectors

1. Assembly and installation of connectors and components should be done in reference to the specified assembly procedures and with the proper amount of tightening torque. Care should be taken that loosening or damage could result when the torque is improperly applied. (Please contact your Hirose representative for the correct procedures.)
2. After mating a connector, pull on the cable slightly to confirm the connector is firmly in place.



HIROSE ELECTRIC CO.,LTD.

2-6-3,Nakagawa Chuoh,Tsuzuki-Ku,Yokohama-Shi 224-8540,JAPAN
 TEL: +81-45-620-3526 Fax: +81-45-591-3726
<http://www.hirose.com>
<http://www.hirose-connectors.com>