

IEC Appliance Inlet C14 with Filter, Circuit Breaker TA45 (recessed)

Standard- or Medical-Filter



Description

- Panel Mount :
Screw-on mounting from front side
- 3 Functions :
Appliance Inlet Protection class I , circuit breaker type TA45 2-pole , Line filter in standard and medical version
- Quick connect terminals 6.3 x 0.8 mm

Approvals

- VDE Certificate Number: 40012935
- UL File Number: E72928

Characteristics

- All single elements are already wired
- Circuit Breaker non-illuminated or illuminated
- Suitable for use in equipment according to IEC/UL 60950
- Suitable for use in medical equipment according to IEC/UL 60601-1

Other versions on request

- Unwired versions
- Other rocker marking
- Medical version M80
- Capacitance CX1
- Variant with notch for V-Lock mating Cordsets

References

Alternative: version without line filter [DF11](#)
Substitute for type [5145](#)
Alternative: Standard version

Weblinks

[pdf datasheet](#), [html-datasheet](#), [General Product Information](#), [RoHS](#), [CHINA-RoHS](#), [REACH](#), [Distributor-Stock-Check](#), [Accessories](#), [Detailed request for product](#)

Technical Data

Ratings IEC	1 - 10A @ Ta 40 °C / 250 VAC; 50Hz
Ratings UL/CSA	1 - 15A @ Ta 40 °C / 250 VAC; 60Hz
Leakage Current	standard < 0.5 mA (250 V / 60Hz) medical < 5 µA (250 V / 60 Hz)
Dielectric Strength	> 1.7 kVDC between L-N > 2.7 kVDC between L/N-PE Test voltage (2 sec)
Allowable Operation Temperature	-10 °C to 55 °C
Climatic Category	10/055/21 acc. to IEC 60068-1
IP-Protection	from front side IP 40 acc. to IEC 60529
Protection Class	Suitable for appliances with protection class I acc. to IEC 61140
Terminal	Quick connect terminals 6.3 x 0.8 mm
Panel Thickness s	Screw: max 8 mm Mounting screw torque max 0.5Nm
Material: Housing	Thermoplastic, black, UL 94V-0

appliance inlet/-outlet	C14 acc. to IEC 60320-1 UL 498, CSA C22.2 no. 42 (for cold conditions) pin-temperature 70 °C, 10A, Protection Class I
Circuit Breakers	Acc. IEC/EN 60934, UL 1077, CSA 22.2 no. 235 2-pole rocker switch, illuminated or non-illuminated. Optional with undervoltage- or remote trip release Short circuit capacity Icn: at In < 3A/240VAC : 10 x In at In ≥ 3A/240VAC : 300A
Line Filter	Standard and Medical Version, IEC 60939, UL 1283, CSA C22.2 no. 8 Technical Details
MTBF	> 100'000h acc. to MIL-HB-217 F

Detailed information on product approvals, code requirements, usage instructions and detailed test conditions can be looked up in [General Product Information](#)

Dimension Screw-on Version

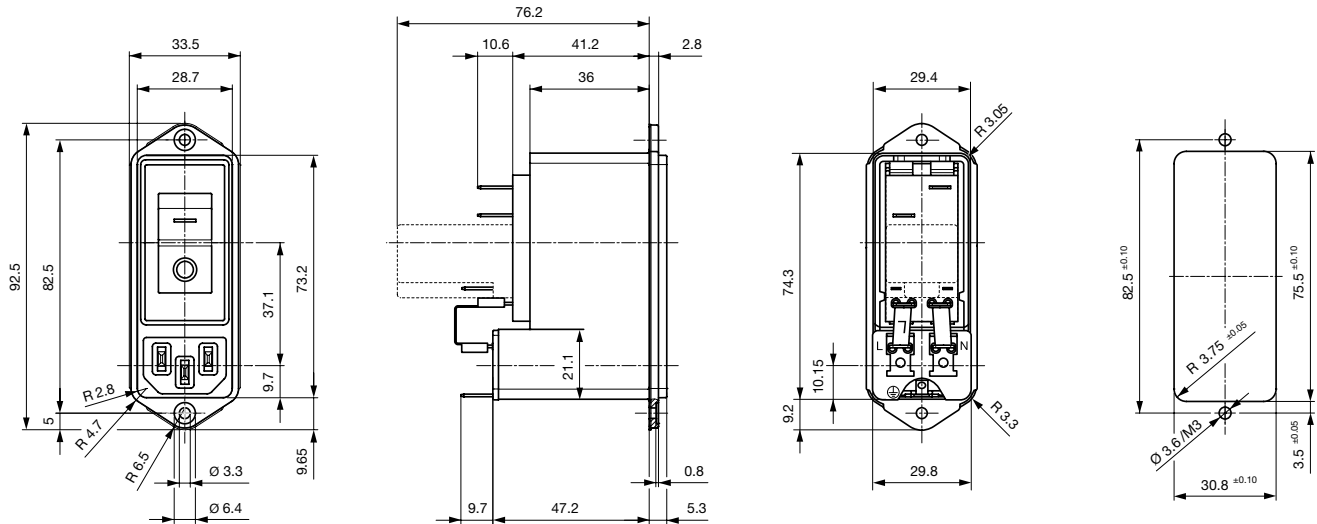

* --- Version TA45 with undervoltage release

Technical Data of Filter-Components

Rated Current [A]	Filter-Type	Inductances L [mH]	Capacitance CX [nF]	Capacitance CY [nF]	R [MΩ]
1	Standard	2 x 11	100	2.2	1
2	Standard	2 x 4	100	2.2	1
3	Standard	2 x 2.5	100	2.2	1
4	Standard	2 x 1.6	100	2.2	1
6	Standard	2 x 0.7	100	2.2	1
8	Standard	2 x 0.6	100	2.2	1
10	Standard	2 x 0.4	100	2.2	1
15	Standard	2 x 0.1	100	2.2	1
2	Medical (M5)	2 x 4	100	-	1
3	Medical (M5)	2 x 2.5	100	-	1
4	Medical (M5)	2 x 1.6	100	-	1
6	Medical (M5)	2 x 0.7	100	-	1
8	Medical (M5)	2 x 0.6	100	-	1
10	Medical (M5)	2 x 0.4	100	-	1
15	Medical (M5)	2 x 0.1	100	-	1

Diagrams

Standard version

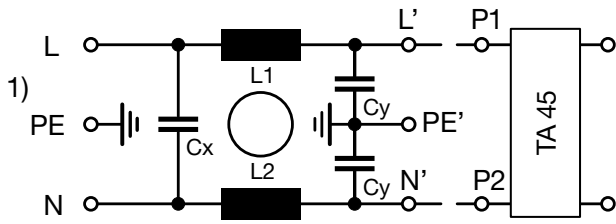

1) Line
2) Load

Medical version (M5)

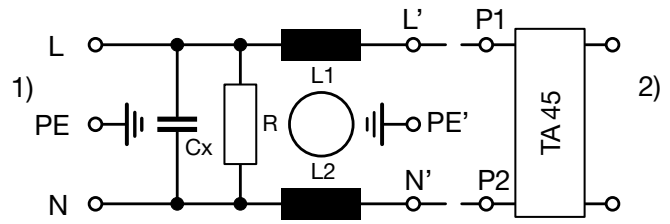

1) Line
2) Load

Attenuation Loss

Standard version

----- 50Ω differential mode _____ 50Ω common mode

1 A

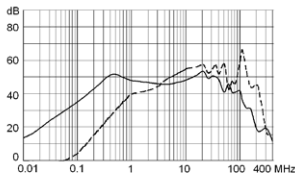

2 A

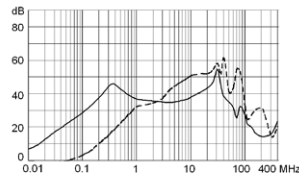

3 A

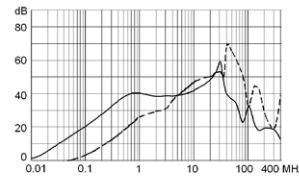

4 A

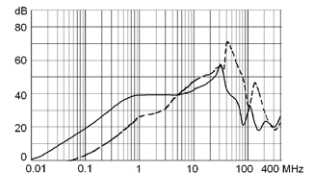

6 A

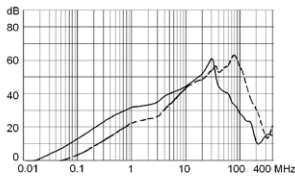

8 A

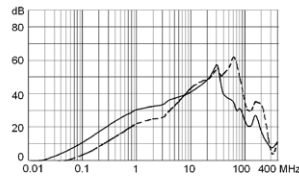

10 A

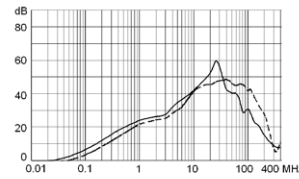

15 A

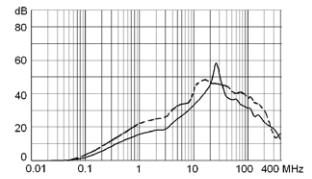

Medical version (M5)

1 A

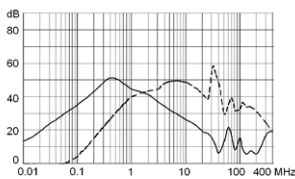

2 A

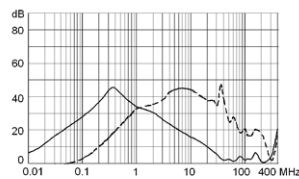

3 A

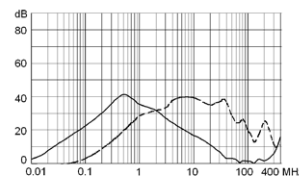

4 A

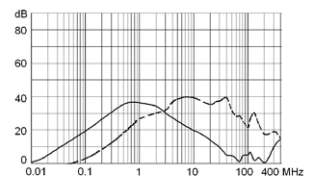

6 A

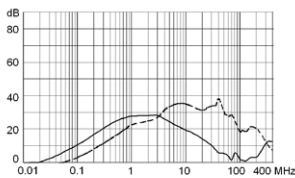

8 A

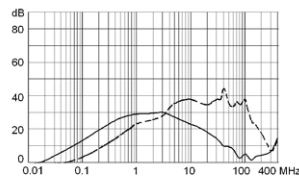

10 A

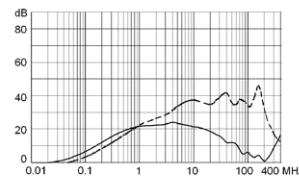

15 A

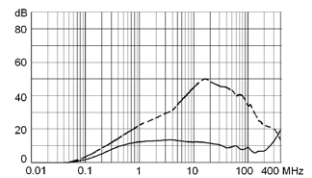

Table 1 Selection for type TA45
Order example



- Circuit Breaker of Equipment
 - 2-pole, rocker actuated
 - Quick connect terminal
- Other types on request

Diagram

Thermal overload protection

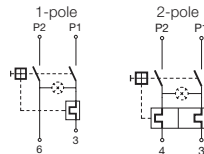

Without illumination

ABT

ABD

With illumination

220...240 V
110...120 V

A12
A14

A32
A34

Colours

Switch front

- W** black
- B** black
- 6** black

Rocker

- white
- black
-
- orange transp.

ABT **W** **F** **150** **C0**

Rocker legend

Surface	Illustration	Colour of print
F embossed / Relief	— ○	
H printed / bedruckt	ON OFF	white / weiss
K printed / bedruckt	ON OFF	black / schwarz
L printed / bedruckt	— ○	white / weiss

Surface	Illustration	Colour of print
M printed	— ○	black
P printed	I ○	white
R printed	I ○	black

Position of the rocker legend
e.g F

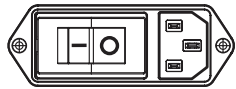

Rated current circuit breaker of equipment

I_n	Code	I_n	Code	I_n	Code	I_n	Code
0,1	J01	1,3	J13	2,8	J28	10,0	100
0,2	J02	1,4	J14	3,0	030	11,0	110
0,3	J03	1,5	J15	3,5	035	12,0	120
0,4	J04	1,6	J16	4,0	040	13,0	130
0,5	J05	1,7	J17	4,5	045	14,0	140
0,6	J06	1,8	J18	5,0	050	15,0	150
0,7	J07	1,9	J19	6,0	060	20,0	200
0,8	J08	2,0	J20	6,5	065		
0,9	J09	2,1	J21	7,0	070		
1,0	J10	2,2	J22	7,5	075		
1,1	J11	2,3	J23	8,0	080		
1,2	J12	2,5	J25	9,0	090		

Without release: code C0

Undervoltage release

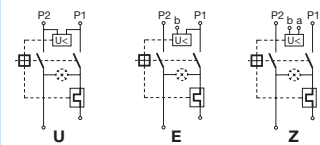

•	•	•
•	•	•
•	•	•

Remote trip release

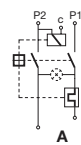

Code	Rated voltage U_n
•	2 240 V AC
•	3 230 V AC
•	4 120 V AC

Technical data (continued)
Circuit breaker

Tripping characteristics
 $I_n < 3 A$

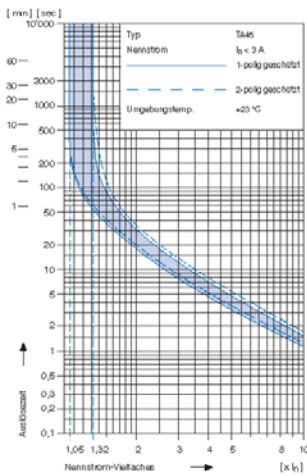

Tripping characteristics
 $I_n \geq 3... \leq 15 A$

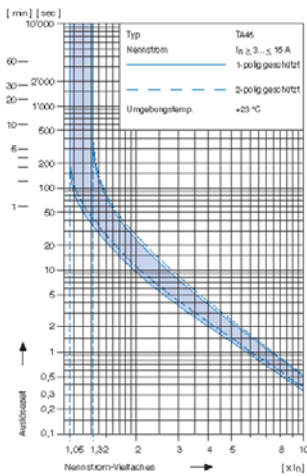

Effect of ambient temperature ¹⁾

The unit is calibrated for an ambient temperature of +23 °C. To determine the rated current for a lower or higher ambient temperature, use a correction factor from the table below.

* Ambient temperature [°C] Correction factor

-10	0,89
-5	0,91
0	0,92
+23	1,00
+30	1,03
+40	1,08
+55	1,16

* Temperature must be measured at the rear of the breaker next to the terminals after equipment operating temperature has been reached.

1) Example

Rated current at +23 °C	6,0 A
Ambient temperature	+40 °C
Correction factor	1,08
Chosen rated current at +40 °C ambient temperature	6 A x 1,08 = 6,5 A

Configuration code (example)

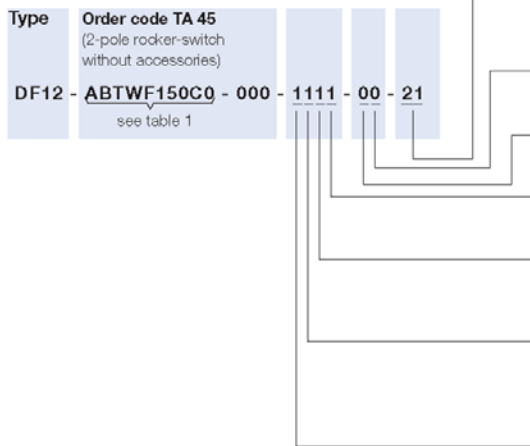

Optional Variants

- 00 standard
- 21 V-Lock notch

Colour

- 0 black

Mounting

- 0 Screw mounting

Terminal PE

- 1 QC 6.3x0.8

Terminal L and N

- 1 QC 6.3x0.8
- 3 Connection to TA45 non insulated

Type of mains filter / capacitor / bleed resistor

- 1 standard X2, Y2 with bleed resistor
- 3 medical M5 X2 with bleed resistor

Rated current ¹⁾

- 1 1A
- 2 2A
- 3 3A
- 4 4A
- 5 6A
- 6 8A
- 7 10A
- 9 15A

1) The rated current of the line-filter must be equal or more than the rated current of TA45

Packaging unit 20 Pcs

Accessories

Description

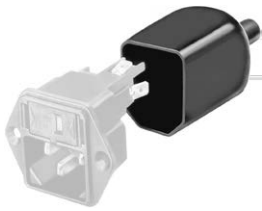

Assorted Covers
Rear Cover

0859.0109

Mating Outlets/Connectors

Category / Description

Appliance Outlet Overview complete



IEC Appliance Outlet F, Screw-on Mounting, Front Side, Solder Terminal	4787
IEC Appliance Outlet F, Snap-in Mounting, Front Side, Solder or Quick-connect Terminal	4788
IEC Appliance Outlet F or H, Screw-on Mounting, Front Side, Solder, PCB or Quick-connect Terminal	5091

[Appliance Outlet further types to DF12](#)

Connector Overview complete



4782 Mounting: Power Cord, 3 x 1 mm ² / 3 x 18 AWG, Cable, Connector: IEC C13	4782
4022 Mounting: Power Supply Cord, 3 x 1.5 mm ² , Screw clamps, Connector: IEC C13	4022
4785 Mounting: Power Cord, 3 x 1 mm ² / 3 x 18 AWG, Cable, Connector: IEC C13	4785
4300-06 Mounting: Power Cord, 3 x 1 mm ² / 3 x 18 AWG, Cable, Connector: IEC C13	4300-06
4012 Mounting: Power Supply Cord, 3 x 1.5 mm ² , Screw clamps, Connector: IEC C13	4012

[Connector further types to DF12](#)

...

Mating Outlets/Connectors shuttered



Power Cord Overview complete

VAC13KS, Overview, diverse Connector IEC C13, cord end:	VAC13KS
---	---------

[Power Cord further types to DF12](#)