

NCS20061/2/4, NCV20061/2/4

3 MHz, 125 μ A Low Power Operational Amplifier

The NCS20061/2/4 is a family of single, dual and quad Operational Amplifiers (Op Amps) with 3 MHz of Gain-Bandwidth Product (GBWP) and draws only 125 μ A of Quiescent current. The NCS2006x has Input Offset Voltage of 4 mV and operates from 1.8 V to 5.5 V supply voltage over a wide temperature range (-40°C to 125°C). The Rail-to-Rail In/Out operation allows the designers to use the entire supply voltage range while taking advantage of the 3 MHz GBWP. Thus, this family offers superior performance over many industry standard parts. These devices are AEC-Q100 qualified which is denoted by the NCV suffix.

NCS2006x's low current consumption and low voltage performance in space saving packages, makes them ideal for sensor signal conditioning and low voltage current sensing applications in Automotive, Consumer and Industrial markets.

Features

- Gain-Bandwidth Product: 3 MHz
- Low Supply Current/ Channel: 125 μ A (typ.)
- Low Input Offset Voltage: 4 mV (max.)
- Wide Supply Range: 1.8 V to 5.5 V
- Wide Temperature Range: -40°C to $+125^{\circ}\text{C}$
- Rail-to-Rail Input and Output
- Unity Gain Stable
- Available in Single, Dual and Quad Packages
- NCV Prefix for Automotive and Other Applications Requiring Unique Site and Control Change Requirements; AEC-Q100 Qualified and PPAP Capable
- These Devices are Pb-Free, Halogen Free/BFR Free and are RoHS Compliant

Applications

- Automotive
- Battery Powered/ Portable Application
- Sensor Signal Conditioning
- Low Voltage Current Sensing
- Filters Circuits
- Unity Gain Buffer

This document contains information on some products that are still under development. ON Semiconductor reserves the right to change or discontinue these products without notice.



ON Semiconductor®

www.onsemi.com



SC70-5
CASE 419A



TSOP-5/SOT23-5
CASE 483



Micro8™/MSOP8
CASE 846A



SOIC-8
CASE 751



TSSOP-8
CASE 948S

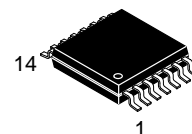

TSSOP-14
CASE 948G

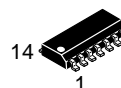

SOIC-14
CASE 751A



UDFN6
CASE 517AP

DEVICE MARKING INFORMATION

See general marking information in the device marking section on page 2 of this data sheet.

ORDERING INFORMATION

See detailed ordering and shipping information on page 3 of this data sheet.

NCS20061/2/4, NCV20061/2/4

MARKING DIAGRAMS

Single Channel Configuration NCS20061, NCV20061

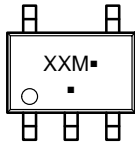

SC70-5
CASE 419A

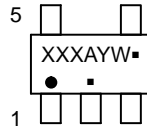

TSOP-5/SOT23-5
CASE 483

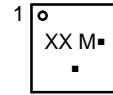

UDFN6
CASE 517AP

Dual Channel Configuration NCS20062, NCV20062

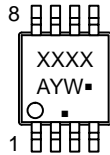

Micro8™/MSOP8
CASE 846A

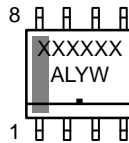

SOIC-8
CASE 751

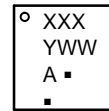

TSSOP-8
CASE 948S

Quad Channel Configuration NCS20064, NCV20064

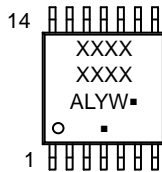

TSSOP-14
CASE 948G

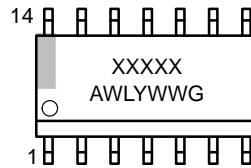

SOIC-14
CASE 751A

XXXXX = Specific Device Code
 A = Assembly Location
 WL, L = Wafer Lot
 Y = Year
 WW, W = Work Week
 G or ■ = Pb-Free Package

(Note: Microdot may be in either location)

NCS20061/2/4, NCV20061/2/4

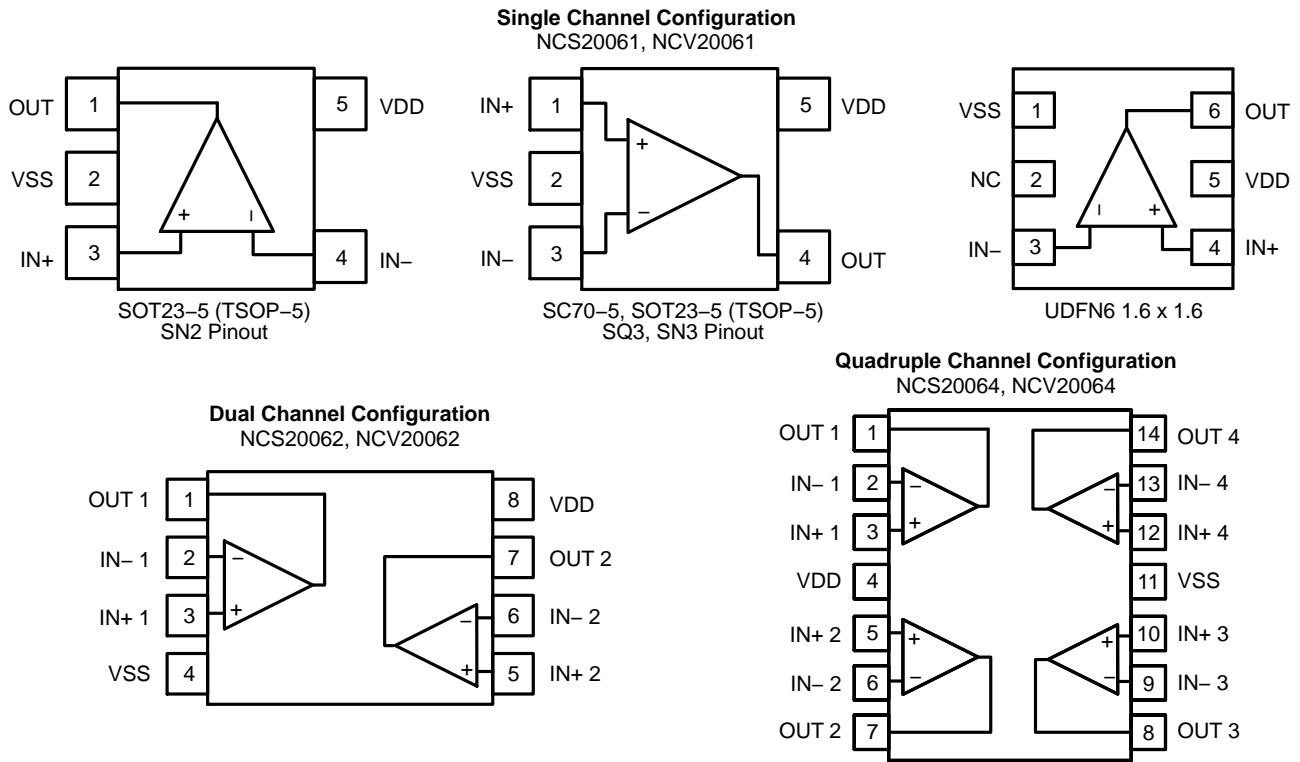

Figure 1. Pin Connections

ORDERING INFORMATION

Device	Configuration	Automotive	Marking	Package	Shipping†	
NCS20061SQ3T2G	Single	No	AAM	SC70	Contact local sales office for more information	
NCS20061SN2T1G			AEP	SOT23-5/TSOP-5		
NCS20061SN3T1G			AEQ	SOT23-5/TSOP-5		
NCS20061MUTAG**			AG	UDFN6		
NCV20061SQ3T2G**			AAM	SC70		
NCV20061SN2T1G	Dual	Yes	AEP	SOT23-5/TSOP-5		
NCS20062DMR2G			No	2K62		Micro8/MSOP8
NCS20062DR2G				NCS20062		SOIC-8
NCS20062DTBR2G				K62		TSSOP-8
NCV20062DMR2G			Yes	2K62		Micro8/MSOP8
NCV20062DR2G				NCS20062		SOIC-8
NCV20062DTBR2G	K62	TSSOP-8				
NCS20064_	Quad**	No	TBD	SOIC-14		
NCS20064_			TBD	SOP-14		
NCS20064_			TBD	TSSOP-14		
NCV20064_			Yes	TBD	SOIC-14	
NCV20064_				TBD	SOP-14	
NCV20064_				TBD	TSSOP-14	

†For information on tape and reel specifications, including part orientation and tape sizes, please refer to our Tape and Reel Packaging Specifications Brochure, BRD8011/D

*NCV Prefix for Automotive and Other Applications Requiring Unique Site and Control Change Requirements; AEC-Q100 Qualified and PPAP Capable.

**In Development. Not yet released.

NCS20061/2/4, NCV20061/2/4

ABSOLUTE MAXIMUM RATINGS (Note 1)

Rating	Symbol	Limit	Unit	
Supply Voltage ($V_{DD} - V_{SS}$) (Note 2)	V_S	7	V	
Input Voltage	V_I	$V_{SS} - 0.5$ to $V_{DD} + 0.5$	V	
Differential Input Voltage	V_{ID}	$\pm V_S$	V	
Maximum Input Current	I_I	± 10	mA	
Maximum Output Current	I_O	± 100	mA	
Continuous Total Power Dissipation (Note 2)	P_D	200	mW	
Maximum Junction Temperature	T_J	150	$^{\circ}\text{C}$	
Storage Temperature Range	T_{STG}	-65 to 150	$^{\circ}\text{C}$	
Mounting Temperature (Infrared or Convection – 20 sec)	T_{mount}	260	$^{\circ}\text{C}$	
ESD Capability (Note 3)	Human Body Model	ESD _{HBM}	2000	V
	Machine Model	ESD _{MM}	100	
	Charge Device Model	ESD _{CDM}	2000	
Latch-Up Current (Note 4)	I_{LU}	100	mA	
Moisture Sensitivity Level (Note 5)	MSL	Level 1		

Stresses exceeding those listed in the Maximum Ratings table may damage the device. If any of these limits are exceeded, device functionality should not be assumed, damage may occur and reliability may be affected.

1. Refer to ELECTRICAL CHARACTERISTICS for Safe Operating Area.
2. Continuous short circuit operation to ground at elevated ambient temperature can result in exceeding the maximum allowed junction temperature of 150 $^{\circ}\text{C}$. Output currents in excess of the maximum output current rating over the long term may adversely affect reliability. Shorting output to either VDD or VSS will adversely affect reliability.
3. This device series incorporates ESD protection and is tested by the following methods:
 ESD Human Body Model tested per AEC-Q100-002 (JEDEC standard: JESD22-A114)
 ESD Machine Model tested per AEC-Q100-003 (JEDEC standard: JESD22-A115)
4. Latch-up Current tested per JEDEC standard: JESD78
5. Moisture Sensitivity Level tested per IPC/JEDEC standard: J-STD-020A

THERMAL INFORMATION

Parameter	Symbol	Channels	Package	Single Layer Board (Note 6)	Multi-Layer Board (Note 7)	Unit
Junction to Ambient Thermal Resistance	θ_{JA}	Single	SC-70			$^{\circ}\text{C}/\text{W}$
			SOT23-5/TSOP-5			
			UDFN6			
		Dual	Micro8/MSOP8	236	167	
			SOIC-8	190	131	
			TSSOP-8	253	194	
		Quad	SOIC-14			
			SOP-14			
			TSSOP-14			

6. Value based on 1S standard PCB according to JEDEC51-3 with 1.0 oz copper and a 300 mm² copper area
7. Value based on 1S2P standard PCB according to JEDEC51-7 with 1.0 oz copper and a 100 mm² copper area

OPERATING RANGES

Parameter	Symbol	Min	Max	Unit
Operating Supply Voltage	V_S	1.8	5.5	V
Differential Input Voltage	V_{ID}		V_S	V
Input Common Mode Range	V_{ICM}	$V_{SS} - 0.2$	$V_{DD} + 0.2$	V
Ambient Temperature	T_A	-40	125	$^{\circ}\text{C}$

Functional operation above the stresses listed in the Recommended Operating Ranges is not implied. Extended exposure to stresses beyond the Recommended Operating Ranges limits may affect device reliability.

NCS20061/2/4, NCV20061/2/4

ELECTRICAL CHARACTERISTICS AT $V_S = 1.8\text{ V}$

$T_A = 25^\circ\text{C}$; $R_L \geq 10\text{ k}\Omega$; $V_{CM} = V_{OUT} = \text{mid-supply}$ unless otherwise noted.

Boldface limits apply over the specified temperature range, $T_A = -40^\circ\text{C}$ to 125°C . (Note 8)

Parameter	Symbol	Conditions	Min	Typ	Max	Unit
INPUT CHARACTERISTICS						
Input Offset Voltage	V_{OS}			0.5	3.5	mV
					4	mV
Offset Voltage Drift	$\Delta V_{OS}/\Delta T$			1		$\mu\text{V}/^\circ\text{C}$
Input Bias Current (Note 8)	I_{IB}			1		pA
					1500	pA
Input Offset Current (Note 8)	I_{OS}			1		pA
					1100	pA
Channel Separation	XTLK	DC		125		dB
Differential Input Resistance	R_{ID}			10		$\text{G}\Omega$
Common Mode Input Resistance	R_{IN}			10		$\text{G}\Omega$
Differential Input Capacitance	C_{ID}			1		pF
Common Mode Input Capacitance	C_{CM}			5		pF
Common Mode Rejection Ratio	CMRR	$V_{CM} = V_{SS} - 0.2$ to $V_{DD} + 0.2$	48	73		dB
		$V_{CM} = V_{SS} + 0.2$ to $V_{DD} - 0.2$	45			
OUTPUT CHARACTERISTICS						
Open Loop Voltage Gain	A_{VOL}		86	120		dB
			80			
Short Circuit Current	I_{SC}	Output to positive rail, sinking current		19		mA
		Output to negative rail, sourcing current		15		
Output Voltage High	V_{OH}	Voltage output swing from positive rail		3	19	mV
					20	
Output Voltage Low	V_{OL}	Voltage output swing from negative rail		3	19	mV
					20	
AC CHARACTERISTICS						
Unity Gain Bandwidth	UGBW			3		MHz
Slew Rate at Unity Gain	SR	$V_{ID} = 1.2\text{ Vpp}$, Gain = 1		1.2		$\text{V}/\mu\text{s}$
Phase Margin	ψ_m			60		$^\circ$
Gain Margin	A_m			10		dB
Settling Time	t_S	$V_{IN} = 1.2\text{ Vpp}$, Gain = 1	Settling time to 0.1%	2.3		μs
			Settling time to 0.01%	6		
Open Loop Output Impedance	Z_{OL}	$f = 100\text{ Hz}$		0.05		Ω
NOISE CHARACTERISTICS						
Total Harmonic Distortion plus Noise	THD+N	$V_{IN} = 1.2\text{ Vpp}$, $f = 1\text{ kHz}$, $A_v = 1$		0.005		%
Input Referred Voltage Noise	e_n	$f = 1\text{ kHz}$		20		$\text{nV}/\sqrt{\text{Hz}}$
		$f = 10\text{ kHz}$		15		
Input Referred Current Noise	i_n	$f = 1\text{ kHz}$		300		$\text{fA}/\sqrt{\text{Hz}}$
SUPPLY CHARACTERISTICS						
Power Supply Rejection Ratio	PSRR	No Load	67	90		dB
			64			
Power Supply Quiescent Current	I_{DD}	Per channel, no load		125	170	μA

8. Performance guaranteed over the indicated operating temperature range by design and/or characterization.

NCS20061/2/4, NCV20061/2/4

ELECTRICAL CHARACTERISTICS AT $V_S = 3.3\text{ V}$

$T_A = 25^\circ\text{C}$; $R_L \geq 10\text{ k}\Omega$; $V_{CM} = V_{OUT} = \text{mid-supply}$ unless otherwise noted.

Boldface limits apply over the specified temperature range, $T_A = -40^\circ\text{C}$ to 125°C . (Note 9)

Parameter	Symbol	Conditions	Min	Typ	Max	Unit
INPUT CHARACTERISTICS						
Input Offset Voltage	V_{OS}			0.5	3.5	mV
					4	mV
Offset Voltage Drift	$\Delta V_{OS}/\Delta T$			1		$\mu\text{V}/^\circ\text{C}$
Input Bias Current (Note 9)	I_{IB}			1		pA
					1500	pA
Input Offset Current (Note 9)	I_{OS}			1		pA
					1100	pA
Channel Separation	XTLK	DC		125		dB
Differential Input Resistance	R_{ID}			10		$\text{G}\Omega$
Common Mode Input Resistance	R_{IN}			10		$\text{G}\Omega$
Differential Input Capacitance	C_{ID}			1		pF
Common Mode Input Capacitance	C_{CM}			5		pF
Common Mode Rejection Ratio	CMRR	$V_{CM} = V_{SS} - 0.2$ to $V_{DD} + 0.2$	53	76		dB
		$V_{CM} = V_{SS} + 0.2$ to $V_{DD} - 0.2$	48			

OUTPUT CHARACTERISTICS						
Open Loop Voltage Gain	A_{VOL}		90	120		dB
			86			
Short Circuit Current	I_{SC}	Output to positive rail, sinking current		19		mA
		Output to negative rail, sourcing current		15		
Output Voltage High	V_{OH}	Voltage output swing from positive rail		3	24	mV
					25	
Output Voltage Low	V_{OL}	Voltage output swing from negative rail		3	24	mV
					25	

AC CHARACTERISTICS						
Unity Gain Bandwidth	UGBW			3		MHz
Slew Rate at Unity Gain	SR	$V_{IN} = 2.5\text{ Vpp}$, Gain = 1		1.2		$\text{V}/\mu\text{s}$
Phase Margin	ψ_m			60		$^\circ$
Gain Margin	A_m			10		dB
Settling Time	t_S	$V_{IN} = 2.5\text{ Vpp}$, Gain = 1	Settling time to 0.1%	2.3		μs
			Settling time to 0.01%	3.1		
Open Loop Output Impedance	Z_{OL}	$f = 100\text{ Hz}$		0.05		Ω

NOISE CHARACTERISTICS						
Total Harmonic Distortion plus Noise	THD+N	$V_{IN} = 2.5\text{ Vpp}$, $f = 1\text{ kHz}$, $A_v = 1$		0.005		%
Input Referred Voltage Noise	e_n	$f = 1\text{ kHz}$		20		$\text{nV}/\sqrt{\text{Hz}}$
			$f = 10\text{ kHz}$		15	
Input Referred Current Noise	i_n	$f = 1\text{ kHz}$		300		$\text{fA}/\sqrt{\text{Hz}}$

SUPPLY CHARACTERISTICS						
Power Supply Rejection Ratio	PSRR	No Load	67	90		dB
			64			
Power Supply Quiescent Current	I_{DD}	Per channel, no load		135	180	μA

9. Performance guaranteed over the indicated operating temperature range by design and/or characterization.

NCS20061/2/4, NCV20061/2/4

ELECTRICAL CHARACTERISTICS AT $V_S = 5.5\text{ V}$

$T_A = 25^\circ\text{C}$; $R_L \geq 10\text{ k}\Omega$; $V_{CM} = V_{OUT} = \text{mid-supply}$ unless otherwise noted.

Boldface limits apply over the specified temperature range, $T_A = -40^\circ\text{C}$ to 125°C . (Note 10)

Parameter	Symbol	Conditions	Min	Typ	Max	Unit
INPUT CHARACTERISTICS						
Input Offset Voltage	V_{OS}			0.5	3.5	mV
					4	mV
Offset Voltage Drift	$\Delta V_{OS}/\Delta T$			1		$\mu\text{V}/^\circ\text{C}$
Input Bias Current (Note 10)	I_{IB}			1		pA
					1500	pA
Input Offset Current (Note 10)	I_{OS}			1		pA
					1100	pA
Channel Separation	XTLK	DC		125		dB
Differential Input Resistance	R_{ID}			10		$\text{G}\Omega$
Common Mode Input Resistance	R_{IN}			10		$\text{G}\Omega$
Differential Input Capacitance	C_{ID}			1		pF
Common Mode Input Capacitance	C_{CM}			5		pF
Common Mode Rejection Ratio	CMRR	$V_{CM} = V_{SS} - 0.2$ to $V_{DD} + 0.2$	55	79		dB
		$V_{CM} = V_{SS} + 0.2$ to $V_{DD} - 0.2$	51			

OUTPUT CHARACTERISTICS						
Open Loop Voltage Gain	A_{VOL}		90	120		dB
			86			
Short Circuit Current	I_{SC}	Output to positive rail, sinking current		19		mA
		Output to negative rail, sourcing current		15		
Output Voltage High	V_{OH}	Voltage output swing from positive rail		3	24	mV
					25	
Output Voltage Low	V_{OL}	Voltage output swing from negative rail		3	24	mV
					25	

AC CHARACTERISTICS						
Unity Gain Bandwidth	UGBW			3		MHz
Slew Rate at Unity Gain	SR	$V_{ID} = 5\text{ Vpp}$, Gain = 1		1.2		$\text{V}/\mu\text{s}$
Phase Margin	ψ_m			60		$^\circ$
Gain Margin	A_m			10		dB
Settling Time	t_S	$V_{IN} = 5\text{ Vpp}$, Gain = 1	Settling time to 0.1%	2.3		μs
			Settling time to 0.01%	3.1		
Open Loop Output Impedance	Z_{OL}	$f = 100\text{ Hz}$		0.05		Ω

NOISE CHARACTERISTICS						
Total Harmonic Distortion plus Noise	THD+N	$V_{IN} = 5\text{ Vpp}$, $f = 1\text{ kHz}$, $A_v = 1$		0.005		%
Input Referred Voltage Noise	e_n		$f = 1\text{ kHz}$	20		$\text{nV}/\sqrt{\text{Hz}}$
			$f = 10\text{ kHz}$	15		
Input Referred Current Noise	i_n		$f = 1\text{ kHz}$	300		$\text{fA}/\sqrt{\text{Hz}}$

SUPPLY CHARACTERISTICS						
Power Supply Rejection Ratio	PSRR	No Load	67	90		dB
			64			
Power Supply Quiescent Current	I_{DD}	Per channel, no load		140	200	μA

10. Performance guaranteed over the indicated operating temperature range by design and/or characterization.

Product parametric performance is indicated in the Electrical Characteristics for the listed test conditions, unless otherwise noted. Product performance may not be indicated by the Electrical Characteristics if operated under different conditions.

TYPICAL PERFORMANCE CHARACTERISTICS

$T_A = 25^\circ\text{C}$, $R_L \geq 10\text{ k}\Omega$, $V_{CM} = V_{OUT} = \text{mid-supply}$ unless otherwise specified

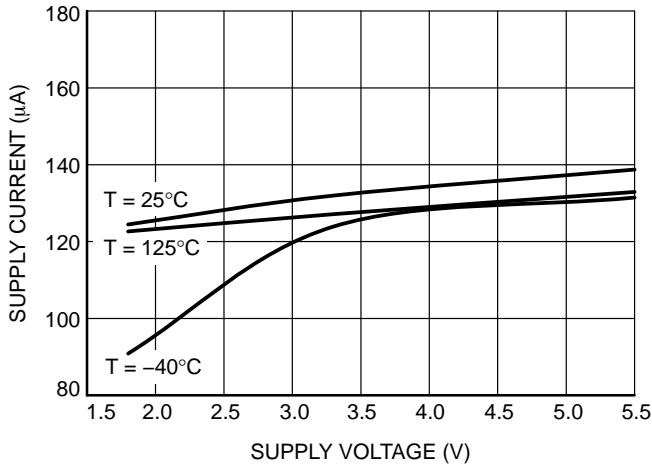

Figure 2. Quiescent Current per Channel vs. Supply Voltage

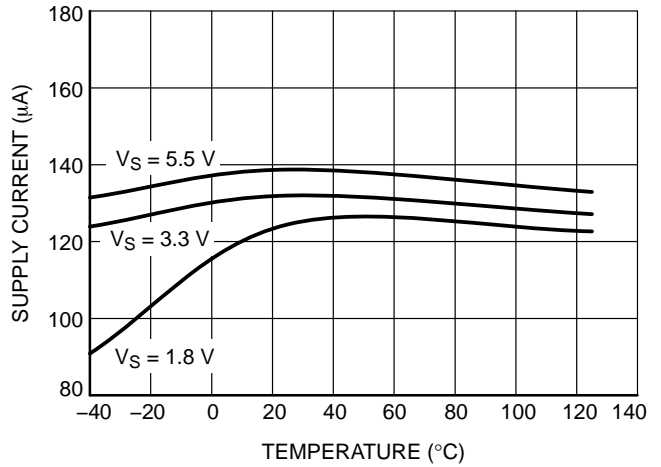

Figure 3. Quiescent Current vs. Temperature

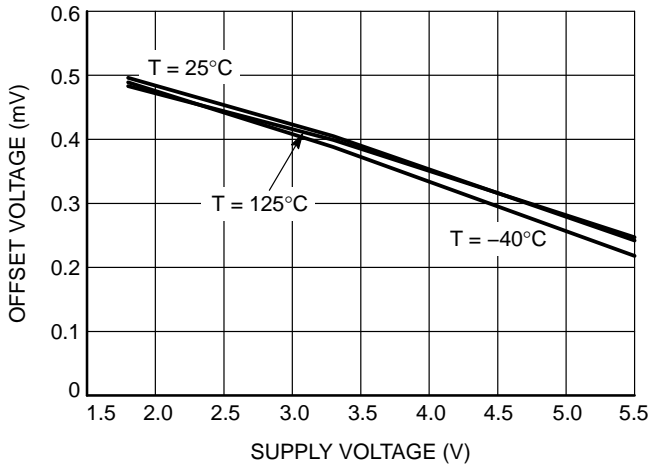

Figure 4. Offset Voltage vs. Supply Voltage

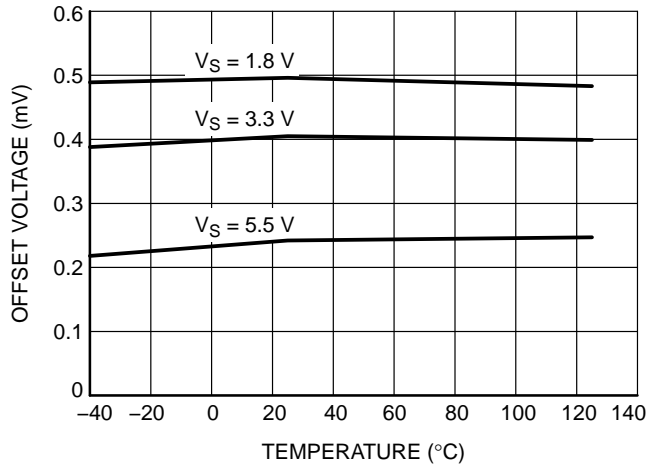

Figure 5. Offset Voltage vs. Temperature

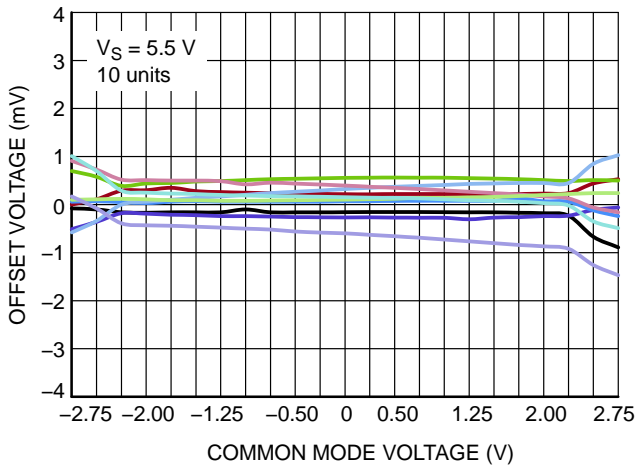

Figure 6. Offset Voltage vs. Common Mode Voltage

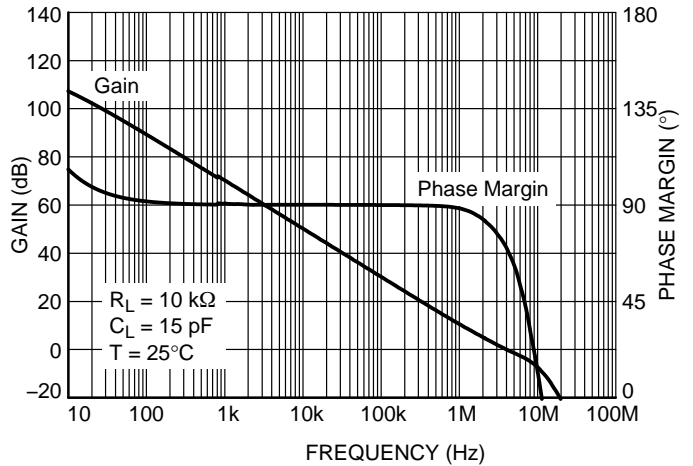

Figure 7. Open-loop Gain and Phase Margin vs. Frequency

TYPICAL PERFORMANCE CHARACTERISTICS

$T_A = 25^\circ\text{C}$, $R_L \geq 10\text{ k}\Omega$, $V_{CM} = V_{OUT} = \text{mid-supply}$ unless otherwise specified

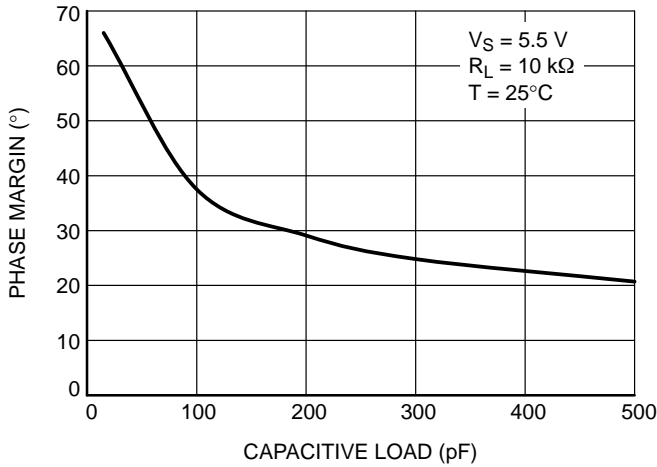

Figure 8. Phase Margin vs. Capacitive Load

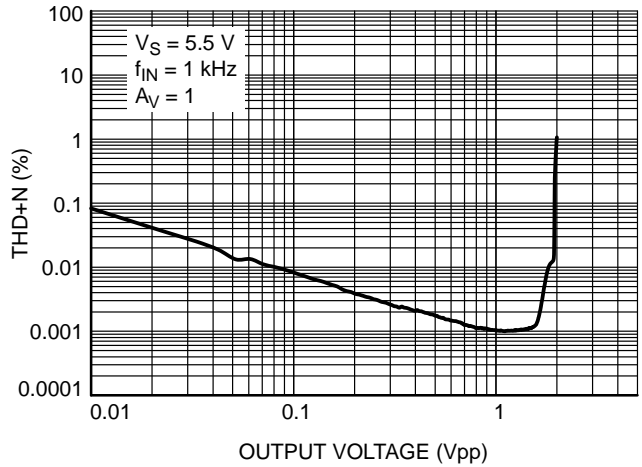

Figure 9. THD + N vs. Output Voltage

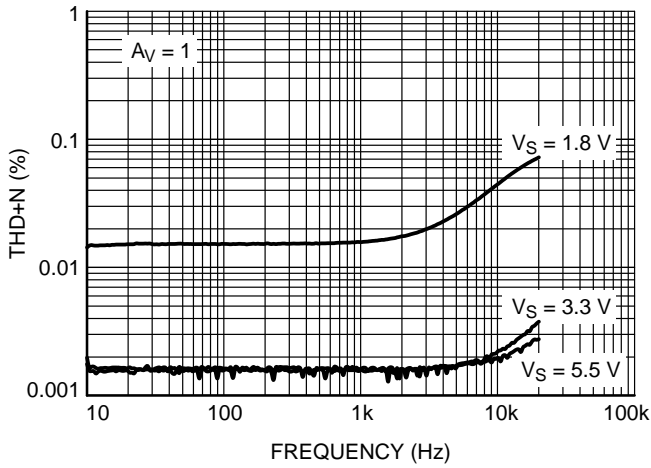

Figure 10. THD + N vs. Frequency

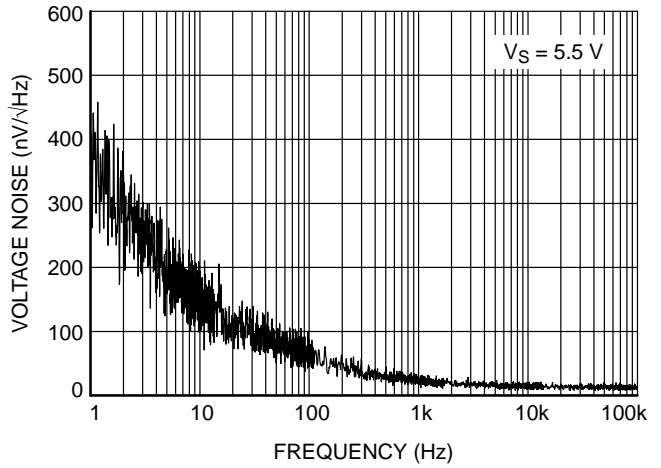

Figure 11. Input Voltage Noise vs. Frequency

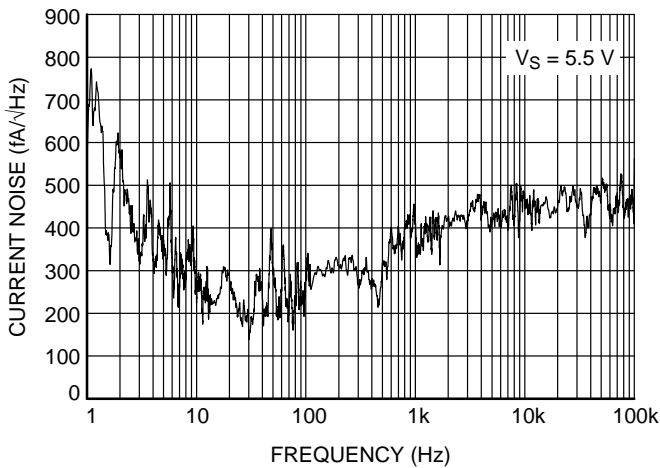

Figure 12. Input Current Noise vs. Frequency

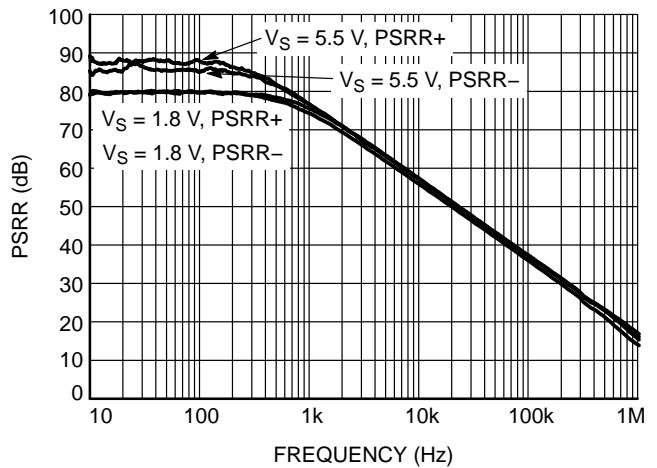

Figure 13. PSRR vs. Frequency

TYPICAL PERFORMANCE CHARACTERISTICS

$T_A = 25^\circ\text{C}$, $R_L \geq 10\text{ k}\Omega$, $V_{CM} = V_{OUT} = \text{mid-supply}$ unless otherwise specified

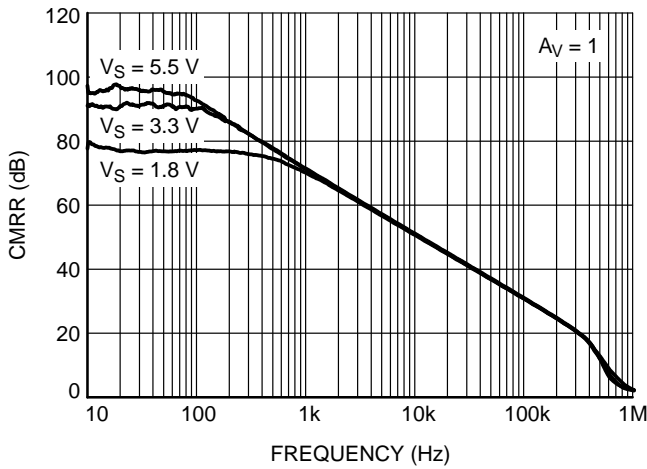

Figure 14. CMRR vs. Frequency

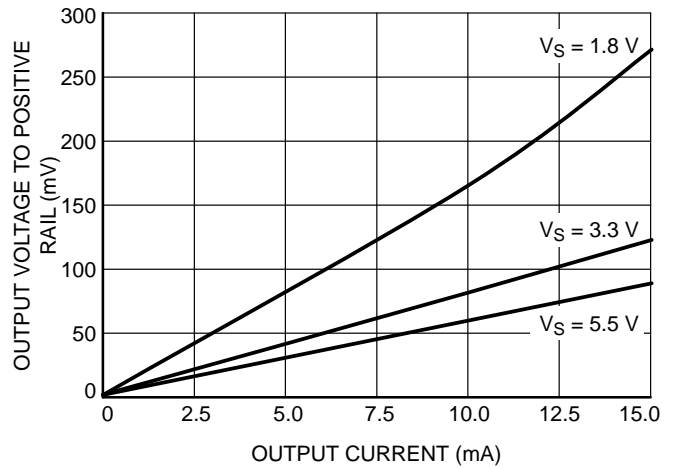

Figure 15. Output Voltage High to Rail

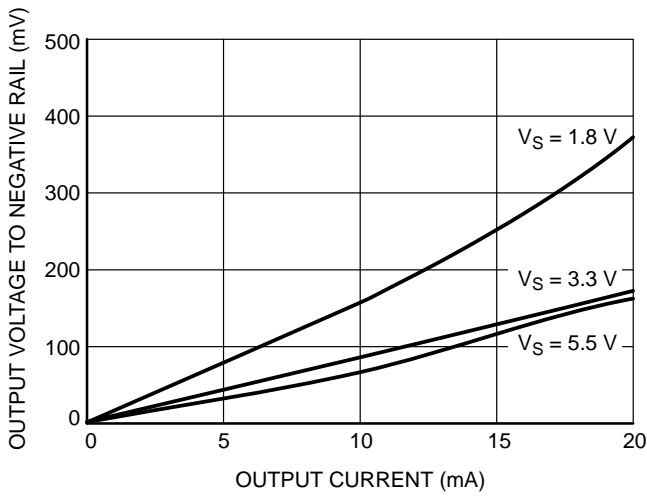

Figure 16. Output Voltage Low to Rail

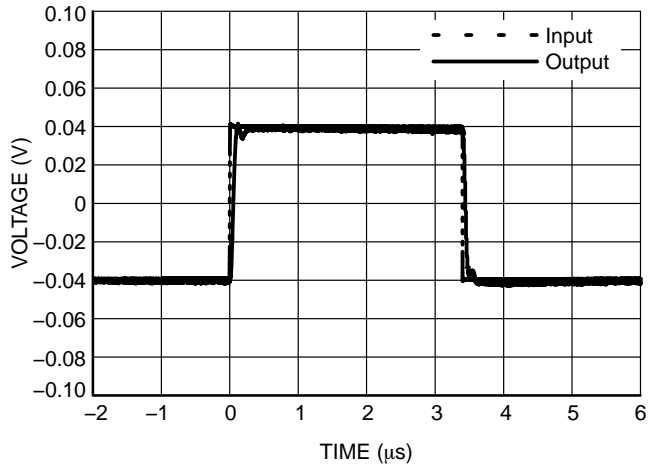

Figure 17. Non-Inverting Small Signal Transient Response

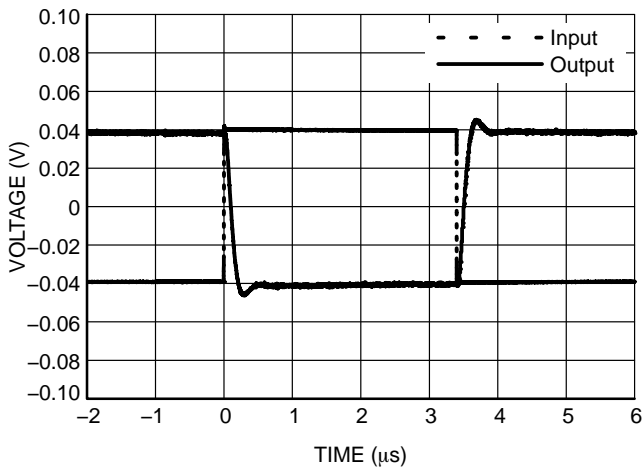

Figure 18. Inverting Small Signal Transient Response

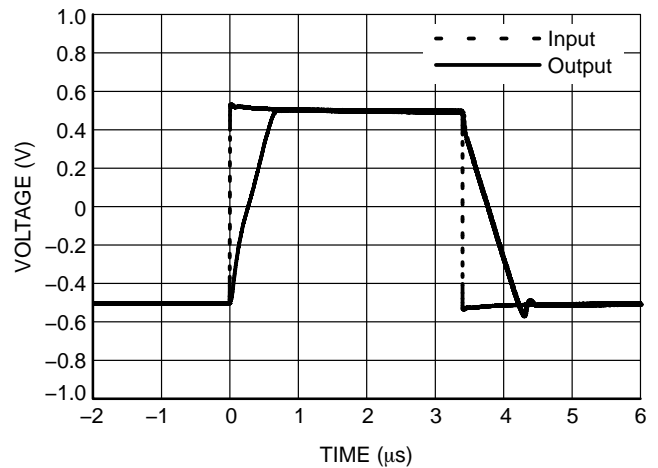

Figure 19. Non-Inverting Large Signal Transient Response

TYPICAL PERFORMANCE CHARACTERISTICS

$T_A = 25^\circ\text{C}$, $R_L \geq 10\text{ k}\Omega$, $V_{CM} = V_{OUT} = \text{mid-supply}$ unless otherwise specified

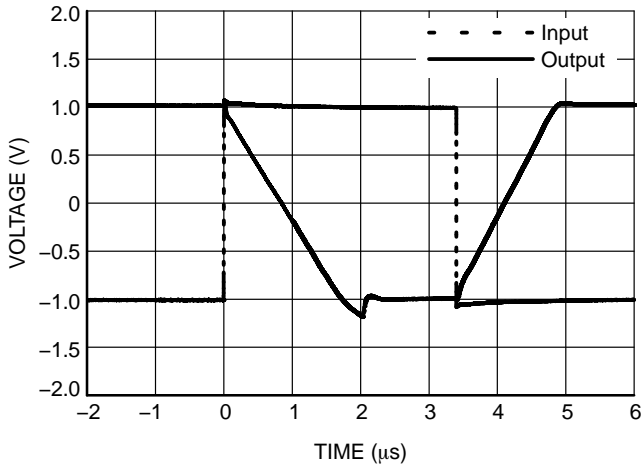

Figure 20. Inverting Large Signal Transient Response

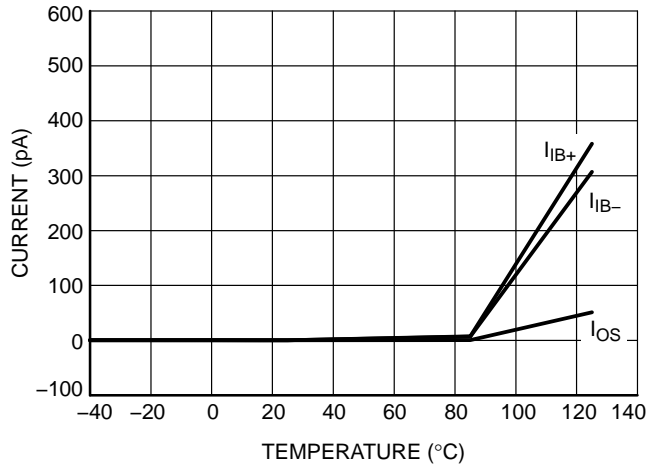

Figure 21. Input Bias and Offset Current vs. Temperature

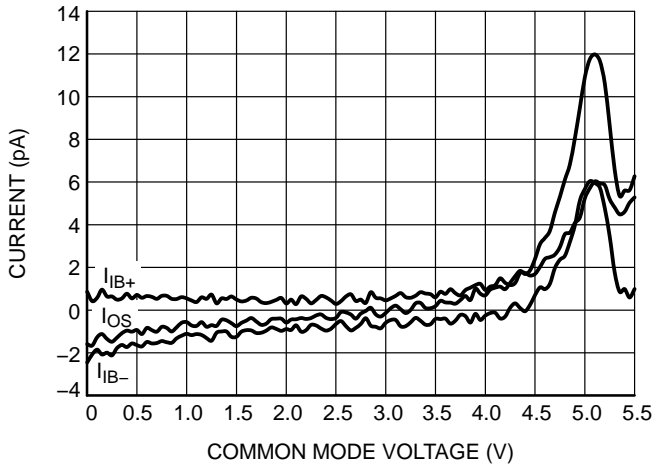

Figure 22. Input Bias Current vs. Common Mode Voltage

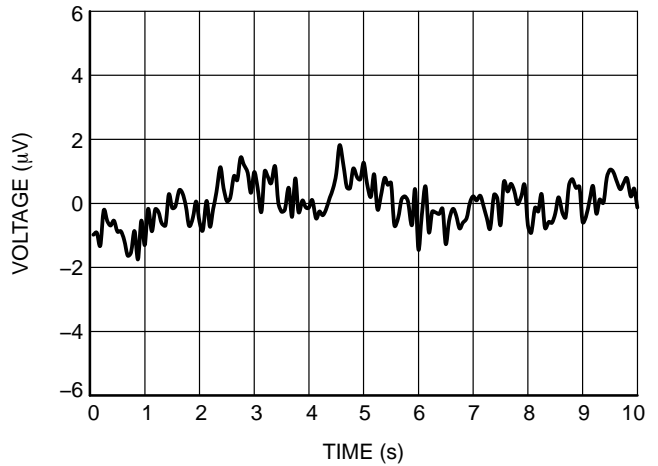

Figure 23. 0.1 Hz to 10 Hz Noise

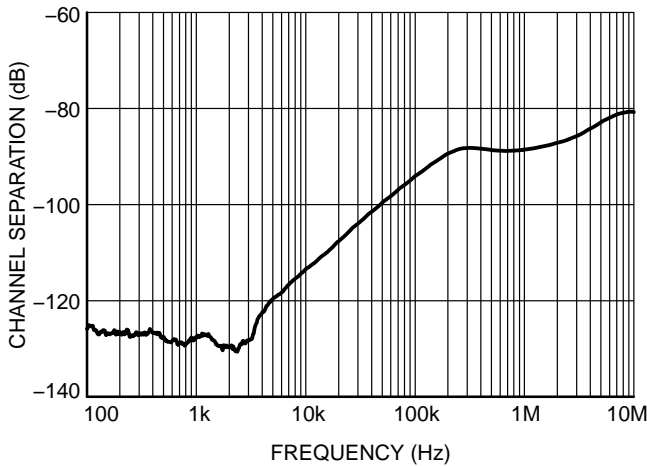

Figure 24. Channel Separation vs. Frequency

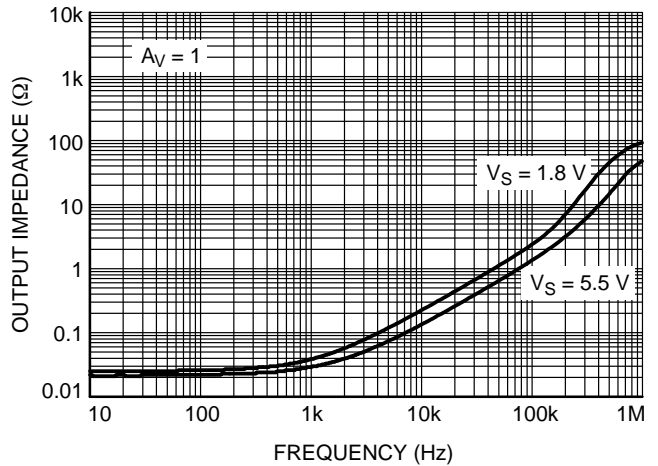

Figure 25. Output Impedance vs. Frequency

TYPICAL PERFORMANCE CHARACTERISTICS

$T_A = 25^\circ\text{C}$, $R_L \geq 10\text{ k}\Omega$, $V_{CM} = V_{OUT} = \text{mid-supply}$ unless otherwise specified

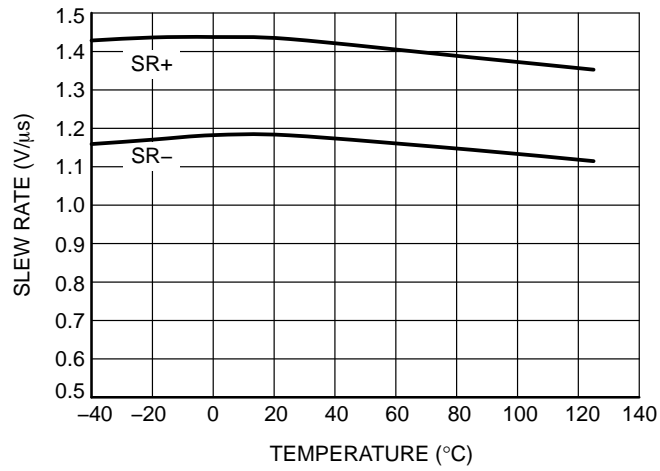
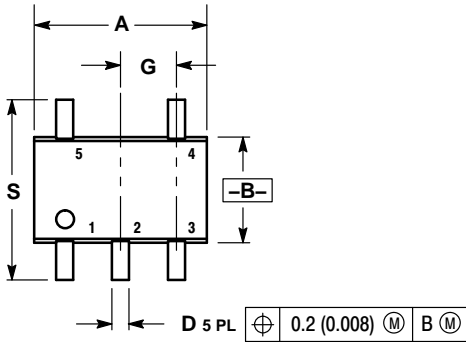

Figure 26. Slew Rate vs. Temperature

PACKAGE DIMENSIONS

SC-88A (SC-70-5/SOT-353)
CASE 419A-02
ISSUE L



NOTES:

1. DIMENSIONING AND TOLERANCING PER ANSI Y14.5M, 1982.
2. CONTROLLING DIMENSION: INCH.
3. 419A-01 OBSOLETE. NEW STANDARD 419A-02.
4. DIMENSIONS A AND B DO NOT INCLUDE MOLD FLASH, PROTRUSIONS, OR GATE BURRS.

DIM	INCHES		MILLIMETERS	
	MIN	MAX	MIN	MAX
A	0.071	0.087	1.80	2.20
B	0.045	0.053	1.15	1.35
C	0.031	0.043	0.80	1.10
D	0.004	0.012	0.10	0.30
G	0.026 BSC		0.65 BSC	
H	---	0.004	---	0.10
J	0.004	0.010	0.10	0.25
K	0.004	0.012	0.10	0.30
N	0.008 REF		0.20 REF	
S	0.079	0.087	2.00	2.20

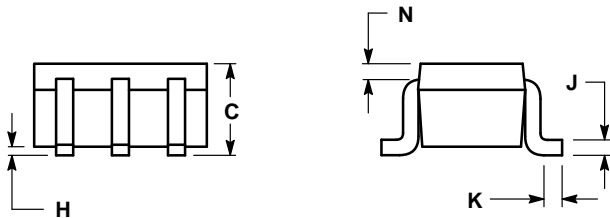

SOLDER FOOTPRINT

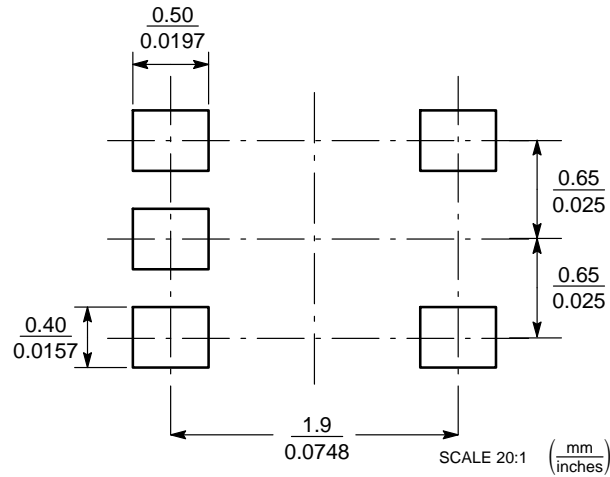

PACKAGE DIMENSIONS

TSOP-5
CASE 483
ISSUE L

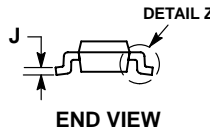
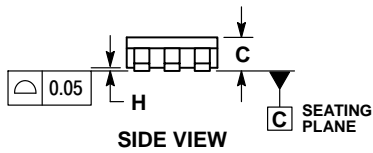
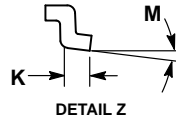
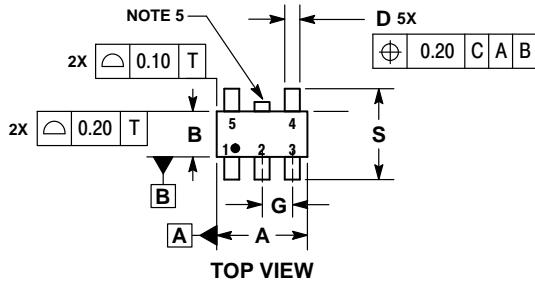

NOTES:

1. DIMENSIONING AND TOLERANCING PER ASME Y14.5M, 1994.
2. CONTROLLING DIMENSION: MILLIMETERS.
3. MAXIMUM LEAD THICKNESS INCLUDES LEAD FINISH THICKNESS. MINIMUM LEAD THICKNESS IS THE MINIMUM THICKNESS OF BASE MATERIAL.
4. DIMENSIONS A AND B DO NOT INCLUDE MOLD FLASH, PROTRUSIONS, OR GATE BURRS. MOLD FLASH, PROTRUSIONS, OR GATE BURRS SHALL NOT EXCEED 0.15 PER SIDE. DIMENSION A.
5. OPTIONAL CONSTRUCTION: AN ADDITIONAL TRIMMED LEAD IS ALLOWED IN THIS LOCATION. TRIMMED LEAD NOT TO EXTEND MORE THAN 0.2 FROM BODY.

DIM	MILLIMETERS	
	MIN	MAX
A	3.00 BSC	
B	1.50 BSC	
C	0.90	1.10
D	0.25	0.50
G	0.95 BSC	
H	0.01	0.10
J	0.10	0.26
K	0.20	0.60
M	0°	10°
S	2.50	3.00

SOLDERING FOOTPRINT*

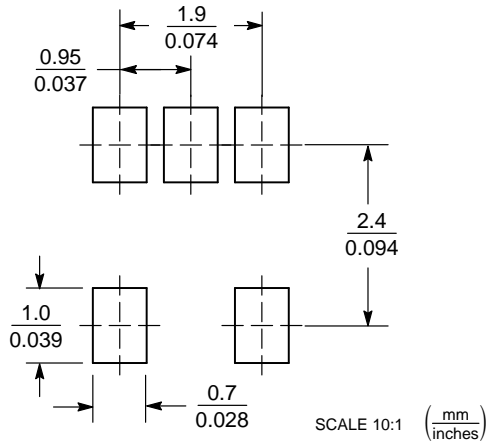

*For additional information on our Pb-Free strategy and soldering details, please download the ON Semiconductor Soldering and Mounting Techniques Reference Manual, SOLDERRM/D.

PACKAGE DIMENSIONS

UDFN6 1.6x1.6, 0.5P
CASE 517AP
ISSUE O

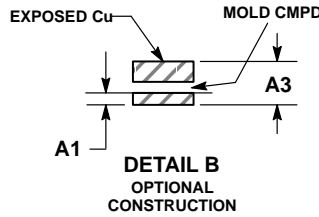
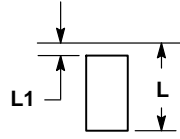
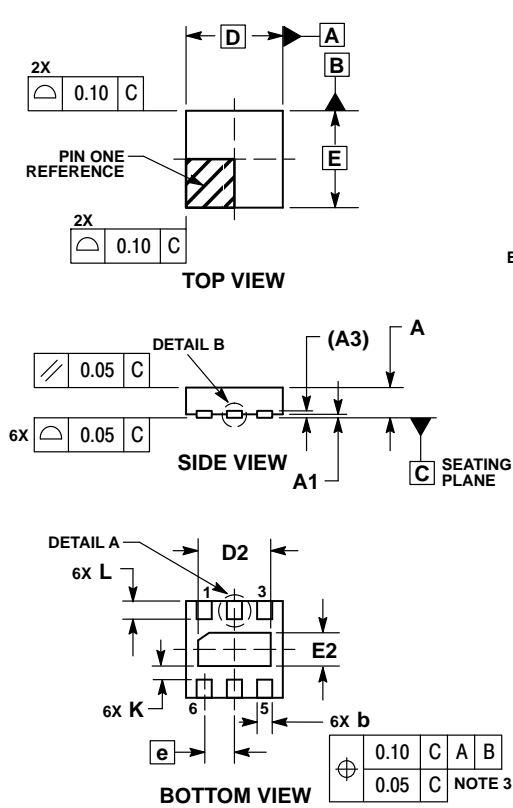

NOTES:

1. DIMENSIONING AND TOLERANCING PER ASME Y14.5M, 1994.
2. CONTROLLING DIMENSION: MILLIMETERS.
3. DIMENSION b APPLIES TO PLATED TERMINAL AND IS MEASURED BETWEEN 0.15 AND 0.30 mm FROM TERMINAL.
4. COPLANARITY APPLIES TO THE EXPOSED PAD AS WELL AS THE TERMINALS.

MILLIMETERS		
DIM	MIN	MAX
A	0.45	0.55
A1	0.00	0.05
A3	0.13	REF
b	0.20	0.30
D	1.60	BSC
E	1.60	BSC
e	0.50	BSC
D2	1.10	1.30
E2	0.45	0.65
K	0.20	---
L	0.20	0.40
L1	0.00	0.15

SOLDERMASK DEFINED MOUNTING FOOTPRINT*

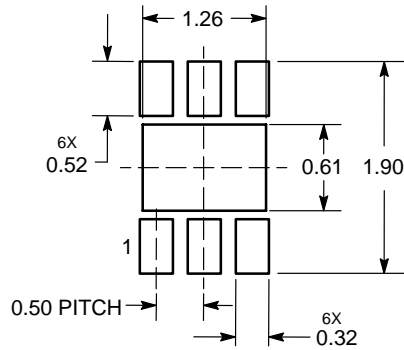

DIMENSIONS: MILLIMETERS

*For additional information on our Pb-Free strategy and soldering details, please download the ON Semiconductor Soldering and Mounting Techniques Reference Manual, SOLDERRM/D.

PACKAGE DIMENSIONS

Micro8™
CASE 846A-02
ISSUE J

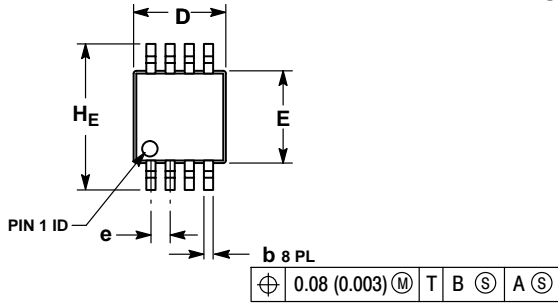

- NOTES:
1. DIMENSIONING AND TOLERANCING PER ANSI Y14.5M, 1982.
 2. CONTROLLING DIMENSION: MILLIMETER.
 3. DIMENSION A DOES NOT INCLUDE MOLD FLASH, PROTRUSIONS OR GATE BURRS. MOLD FLASH, PROTRUSIONS OR GATE BURRS SHALL NOT EXCEED 0.15 (0.006) PER SIDE.
 4. DIMENSION B DOES NOT INCLUDE INTERLEAD FLASH OR PROTRUSION. INTERLEAD FLASH OR PROTRUSION SHALL NOT EXCEED 0.25 (0.010) PER SIDE.
 5. 846A-01 OBSOLETE, NEW STANDARD 846A-02.

DIM	MILLIMETERS			INCHES		
	MIN	NOM	MAX	MIN	NOM	MAX
A	—	—	1.10	—	—	0.043
A1	0.05	0.08	0.15	0.002	0.003	0.006
b	0.25	0.33	0.40	0.010	0.013	0.016
c	0.13	0.18	0.23	0.005	0.007	0.009
D	2.90	3.00	3.10	0.114	0.118	0.122
E	2.90	3.00	3.10	0.114	0.118	0.122
e	0.65 BSC			0.026 BSC		
L	0.40	0.55	0.70	0.016	0.021	0.028
HE	4.75	4.90	5.05	0.187	0.193	0.199

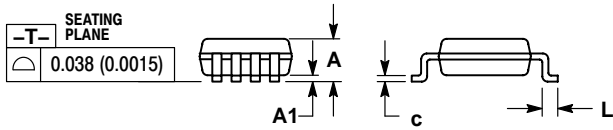

RECOMMENDED
SOLDERING FOOTPRINT*

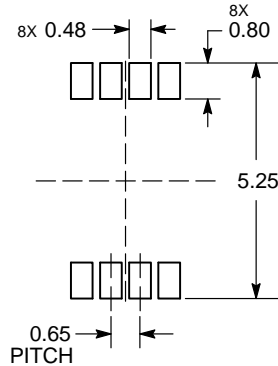

DIMENSION: MILLIMETERS

*For additional information on our Pb-Free strategy and soldering details, please download the ON Semiconductor Soldering and Mounting Techniques Reference Manual, SOLDERRM/D.

PACKAGE DIMENSIONS

SOIC-8 NB
CASE 751-07
ISSUE AK

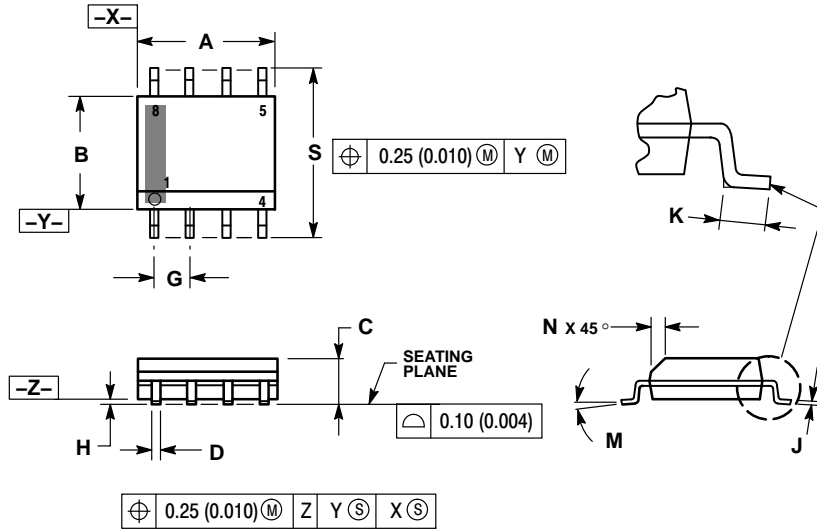

- NOTES:
1. DIMENSIONING AND TOLERANCING PER ANSI Y14.5M, 1982.
 2. CONTROLLING DIMENSION: MILLIMETER.
 3. DIMENSION A AND B DO NOT INCLUDE MOLD PROTRUSION.
 4. MAXIMUM MOLD PROTRUSION 0.15 (0.006) PER SIDE.
 5. DIMENSION D DOES NOT INCLUDE DAMBAR PROTRUSION. ALLOWABLE DAMBAR PROTRUSION SHALL BE 0.127 (0.005) TOTAL IN EXCESS OF THE D DIMENSION AT MAXIMUM MATERIAL CONDITION.
 6. 751-01 THRU 751-06 ARE OBSOLETE. NEW STANDARD IS 751-07.

DIM	MILLIMETERS		INCHES	
	MIN	MAX	MIN	MAX
A	4.80	5.00	0.189	0.197
B	3.80	4.00	0.150	0.157
C	1.35	1.75	0.053	0.069
D	0.33	0.51	0.013	0.020
G	1.27 BSC		0.050 BSC	
H	0.10	0.25	0.004	0.010
J	0.19	0.25	0.007	0.010
K	0.40	1.27	0.016	0.050
M	0°	8°	0°	8°
N	0.25	0.50	0.010	0.020
S	5.80	6.20	0.228	0.244

- STYLE 11:
- PIN 1. SOURCE 1
2. GATE 1
3. SOURCE 2
4. GATE 2
5. DRAIN 2
6. DRAIN 2
7. DRAIN 1
8. DRAIN 1

SOLDERING FOOTPRINT*

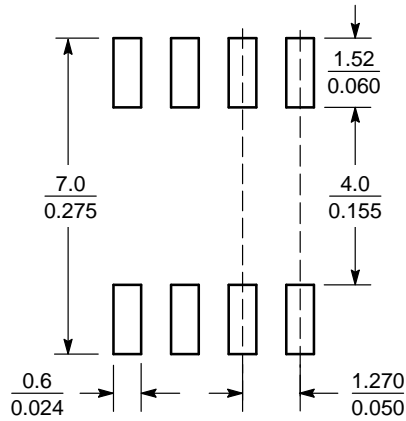

SCALE 6:1 (mm/inches)

*For additional information on our Pb-Free strategy and soldering details, please download the ON Semiconductor Soldering and Mounting Techniques Reference Manual, SOLDERRM/D.

PACKAGE DIMENSIONS

TSSOP-8
CASE 948S
ISSUE C

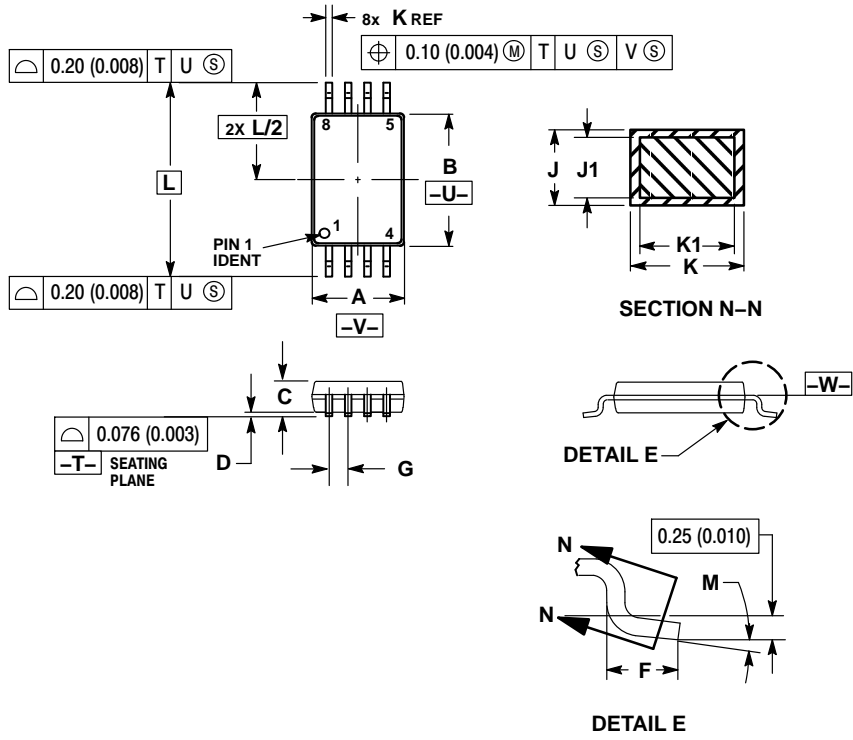

- NOTES:
1. DIMENSIONING AND TOLERANCING PER ANSI Y14.5M, 1982.
 2. CONTROLLING DIMENSION: MILLIMETER.
 3. DIMENSION A DOES NOT INCLUDE MOLD FLASH, PROTRUSIONS OR GATE BURRS. MOLD FLASH OR GATE BURRS SHALL NOT EXCEED 0.15 (0.006) PER SIDE.
 4. DIMENSION B DOES NOT INCLUDE INTERLEAD FLASH OR PROTRUSION. INTERLEAD FLASH OR PROTRUSION SHALL NOT EXCEED 0.25 (0.010) PER SIDE.
 5. TERMINAL NUMBERS ARE SHOWN FOR REFERENCE ONLY.
 6. DIMENSION A AND B ARE TO BE DETERMINED AT DATUM PLANE -W-.

DIM	MILLIMETERS		INCHES	
	MIN	MAX	MIN	MAX
A	2.90	3.10	0.114	0.122
B	4.30	4.50	0.169	0.177
C	---	1.10	---	0.043
D	0.05	0.15	0.002	0.006
F	0.50	0.70	0.020	0.028
G	0.65 BSC		0.026 BSC	
J	0.09	0.20	0.004	0.008
J1	0.09	0.16	0.004	0.006
K	0.19	0.30	0.007	0.012
K1	0.19	0.25	0.007	0.010
L	6.40 BSC		0.252 BSC	
M	0°	8°	0°	8°

PACKAGE DIMENSIONS

SOIC-14 NB
CASE 751A-03
ISSUE K

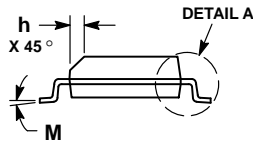
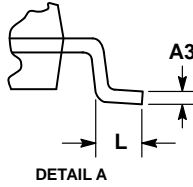
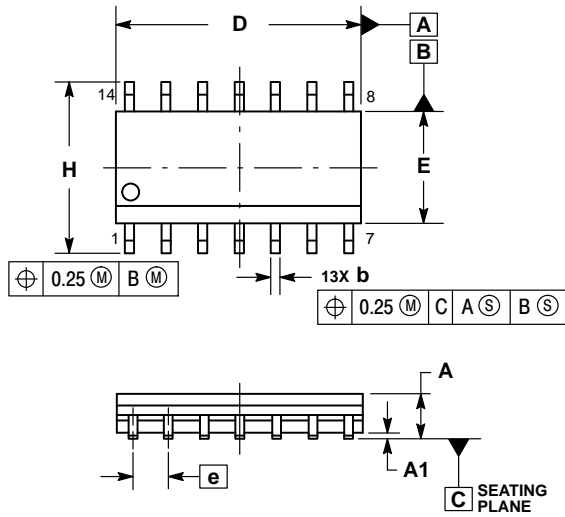

NOTES:

1. DIMENSIONING AND TOLERANCING PER ASME Y14.5M, 1994.
2. CONTROLLING DIMENSION: MILLIMETERS.
3. DIMENSION b DOES NOT INCLUDE DAMBAR PROTRUSION. ALLOWABLE PROTRUSION SHALL BE 0.13 TOTAL IN EXCESS OF AT MAXIMUM MATERIAL CONDITION.
4. DIMENSIONS D AND E DO NOT INCLUDE MOLD PROTRUSIONS.
5. MAXIMUM MOLD PROTRUSION 0.15 PER SIDE.

DIM	MILLIMETERS		INCHES	
	MIN	MAX	MIN	MAX
A	1.35	1.75	0.054	0.068
A1	0.10	0.25	0.004	0.010
A3	0.19	0.25	0.008	0.010
b	0.35	0.49	0.014	0.019
D	8.55	8.75	0.337	0.344
E	3.80	4.00	0.150	0.157
e	1.27 BSC		0.050 BSC	
H	5.80	6.20	0.228	0.244
h	0.25	0.50	0.010	0.019
L	0.40	1.25	0.016	0.049
M	0°	7°	0°	7°

SOLDERING FOOTPRINT*

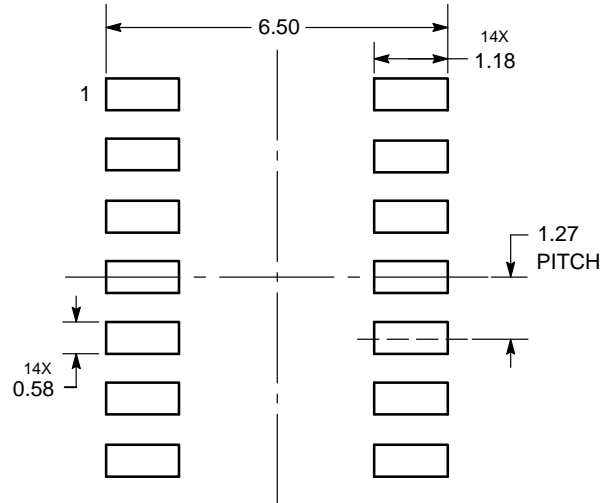

DIMENSIONS: MILLIMETERS

*For additional information on our Pb-Free strategy and soldering details, please download the ON Semiconductor Soldering and Mounting Techniques Reference Manual, SOLDERRM/D.

PACKAGE DIMENSIONS

TSSOP-14
CASE 948G
ISSUE B

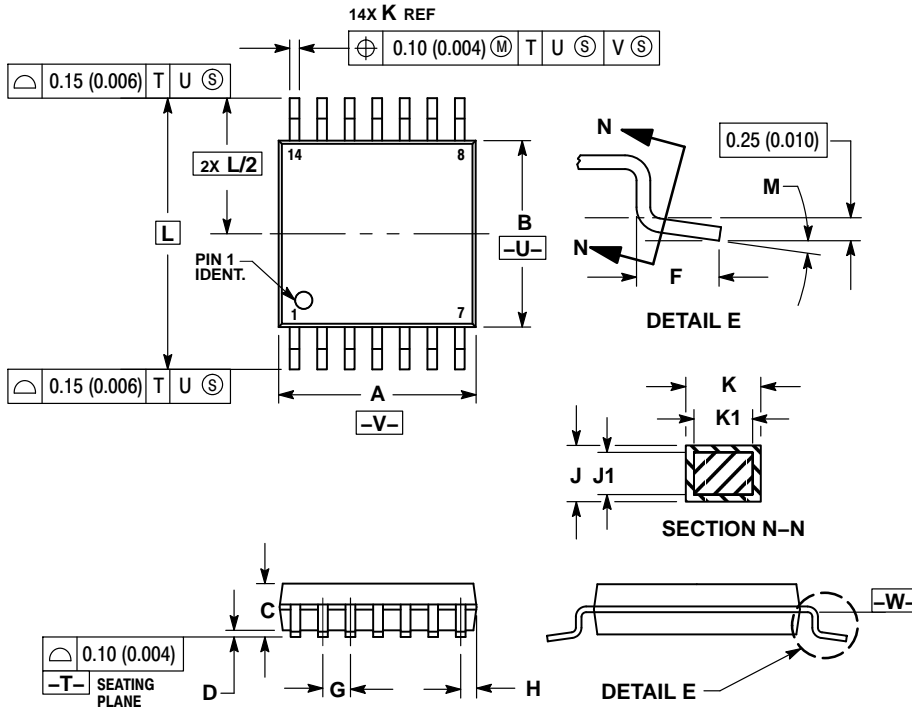

- NOTES:
1. DIMENSIONING AND TOLERANCING PER ANSI Y14.5M, 1982.
 2. CONTROLLING DIMENSION: MILLIMETER.
 3. DIMENSION A DOES NOT INCLUDE MOLD FLASH, PROTRUSIONS OR GATE BURRS. MOLD FLASH OR GATE BURRS SHALL NOT EXCEED 0.15 (0.006) PER SIDE.
 4. DIMENSION B DOES NOT INCLUDE INTERLEAD FLASH OR PROTRUSION. INTERLEAD FLASH OR PROTRUSION SHALL NOT EXCEED 0.25 (0.010) PER SIDE.
 5. DIMENSION K DOES NOT INCLUDE DAMBAR PROTRUSION. ALLOWABLE DAMBAR PROTRUSION SHALL BE 0.08 (0.003) TOTAL IN EXCESS OF THE K DIMENSION AT MAXIMUM MATERIAL CONDITION.
 6. TERMINAL NUMBERS ARE SHOWN FOR REFERENCE ONLY.
 7. DIMENSION A AND B ARE TO BE DETERMINED AT DATUM PLANE -W-.

DIM	MILLIMETERS		INCHES	
	MIN	MAX	MIN	MAX
A	4.90	5.10	0.193	0.200
B	4.30	4.50	0.169	0.177
C	---	1.20	---	0.047
D	0.05	0.15	0.002	0.006
F	0.50	0.75	0.020	0.030
G	0.65 BSC		0.026 BSC	
H	0.50	0.60	0.020	0.024
J	0.09	0.20	0.004	0.008
J1	0.09	0.16	0.004	0.006
K	0.19	0.30	0.007	0.012
K1	0.19	0.25	0.007	0.010
L	6.40 BSC		0.252 BSC	
M	0°	8°	0°	8°

SOLDERING FOOTPRINT

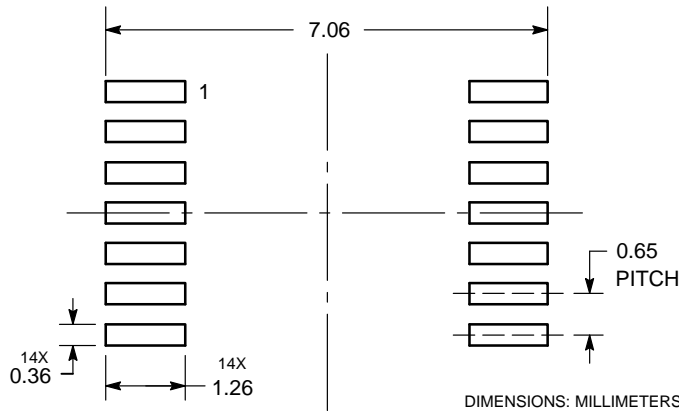

Micro8 is a trademark of International Rectifier

ON Semiconductor and are trademarks of Semiconductor Components Industries, LLC dba ON Semiconductor or its subsidiaries in the United States and/or other countries. ON Semiconductor owns the rights to a number of patents, trademarks, copyrights, trade secrets, and other intellectual property. A listing of ON Semiconductor's product/patent coverage may be accessed at www.onsemi.com/site/pdf/Patent-Marking.pdf. ON Semiconductor reserves the right to make changes without further notice to any products herein. ON Semiconductor makes no warranty, representation or guarantee regarding the suitability of its products for any particular purpose, nor does ON Semiconductor assume any liability arising out of the application or use of any product or circuit, and specifically disclaims any and all liability, including without limitation special, consequential or incidental damages. Buyer is responsible for its products and applications using ON Semiconductor products, including compliance with all laws, regulations and safety requirements or standards, regardless of any support or applications information provided by ON Semiconductor. "Typical" parameters which may be provided in ON Semiconductor data sheets and/or specifications can and do vary in different applications and actual performance may vary over time. All operating parameters, including "Typicals" must be validated for each customer application by customer's technical experts. ON Semiconductor does not convey any license under its patent rights nor the rights of others. ON Semiconductor products are not designed, intended, or authorized for use as a critical component in life support systems or any FDA Class 3 medical devices or medical devices with a same or similar classification in a foreign jurisdiction or any devices intended for implantation in the human body. Should Buyer purchase or use ON Semiconductor products for any such unintended or unauthorized application, Buyer shall indemnify and hold ON Semiconductor and its officers, employees, subsidiaries, affiliates, and distributors harmless against all claims, costs, damages, and expenses, and reasonable attorney fees arising out of, directly or indirectly, any claim of personal injury or death associated with such unintended or unauthorized use, even if such claim alleges that ON Semiconductor was negligent regarding the design or manufacture of the part. ON Semiconductor is an Equal Opportunity/Affirmative Action Employer. This literature is subject to all applicable copyright laws and is not for resale in any manner.

PUBLICATION ORDERING INFORMATION

LITERATURE FULFILLMENT:
Literature Distribution Center for ON Semiconductor
19521 E. 32nd Pkwy, Aurora, Colorado 80011 USA
Phone: 303-675-2175 or 800-344-3860 Toll Free USA/Canada
Fax: 303-675-2176 or 800-344-3867 Toll Free USA/Canada
Email: orderlit@onsemi.com

N. American Technical Support: 800-282-9855 Toll Free
USA/Canada
Europe, Middle East and Africa Technical Support:
Phone: 421 33 790 2910
Japan Customer Focus Center
Phone: 81-3-5817-1050

ON Semiconductor Website: www.onsemi.com
Order Literature: <http://www.onsemi.com/orderlit>
For additional information, please contact your local Sales Representative