

THESE DRAWINGS ARE THE PROPERTY OF QUALTEK ELECTRONICS AND NOT TO BE REPRODUCED FOR OR COMMUNICATED TO A THIRD PARTY WITHOUT THE EXPRESS WRITTEN PERMISSION OF AN OFFICER OF QUALTEK ELECTRONICS.

REVISION			
REV.	DESCRIPTION	DATE	APPROVED

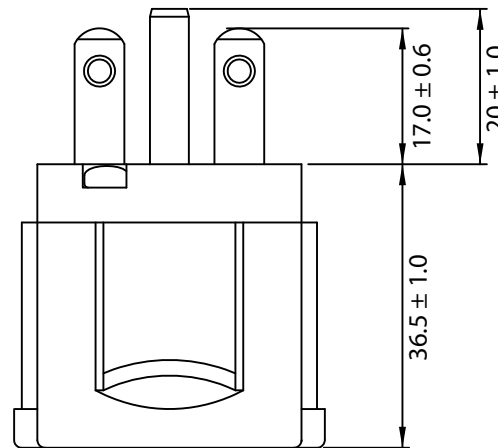
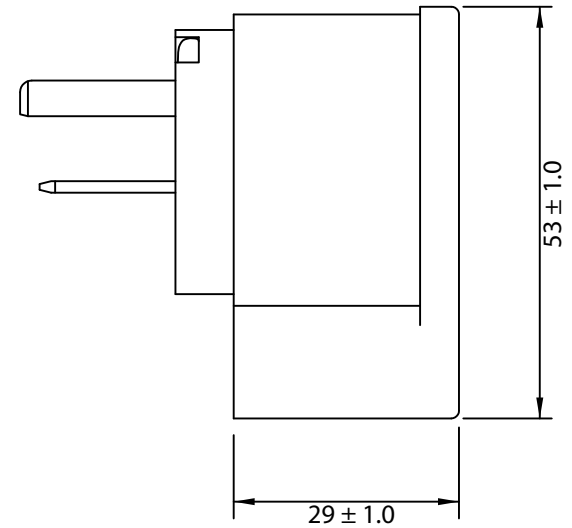
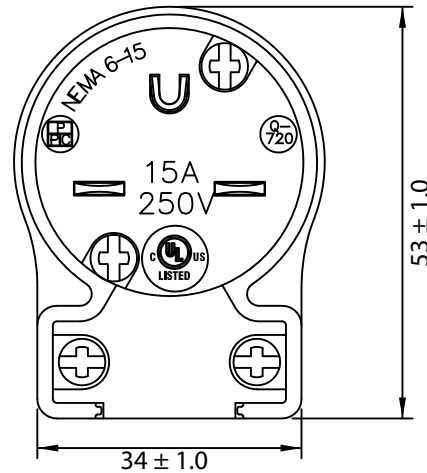
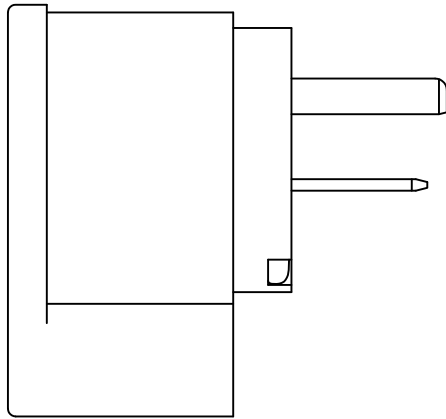

CONTROLLED

NOTES:

1. RATING: 15A 250VAC
2. COLOR: BLACK
3. CORD CLAMP: ACCEPTS 18/3 - 12/3 CABLE
4. TERMINAL I.D.:
 - A. GROUND TERMINAL SCREW GREEN AND MARKED "GR"
 - B. LINE WIRES TERMINAL SCREWS COLORED BLACK
5. APPROVALS: UL/cUL LISTED: E139592
6. 8 POSITION PLUG CONFIGURATION
7. ROHS COMPLIANT

Dim range (mm)	Tolerance +/- (mm)	Qualtek Electronics Corp. PPC DIVISION		
		Part Number:	Q-720-RA	RoHS Compliant
0-1	0.15	Description: NEMA 6-15P ANGLED STRAIGHT BLADE DEVICE		
1-6	0.20			
6-18	0.30	UNIT: mm		
18-50	0.50			
50-120	0.70	Drawn / Date	Checked / Date	Approved / Date
120-250	0.90	R.Nuti 12-14-17	12-14-17	LY / 12-14-17
250-500	1.20			