

Digital Attenuator 15.5 dB, 5-Bit, TTL Driver, DC-3.5 GHz

Rev. V4

Features

- Attenuation: 0.5 dB Steps to 15.5 dB
- Low DC Power Consumption
- Small Footprint, JEDEC Package
- Integral TTL Driver
- 50 ohm Impedance
- Test Boards are Available
- Tape and Reel Packaging Available
- Lead-Free CSP-1 Package
- 100% Matte Tin Plating over Copper
- Halogen-Free “Green” Mold Compound
- 260°C Reflow Compatible
- RoHS* Compliant Version of AT90-0283

Description

M/A-COM's MAAD-007081-000100 is a GaAs FET 5-bit digital attenuator with integral TTL driver. Step size is 0.5 dB providing a 15.5 dB total attenuation range. This device is in an PQFN plastic surface mount package. MAAD-007081-000100 is ideally suited for use where accuracy, fast speed, very low power consumption and low costs are required.

Functional Schematic

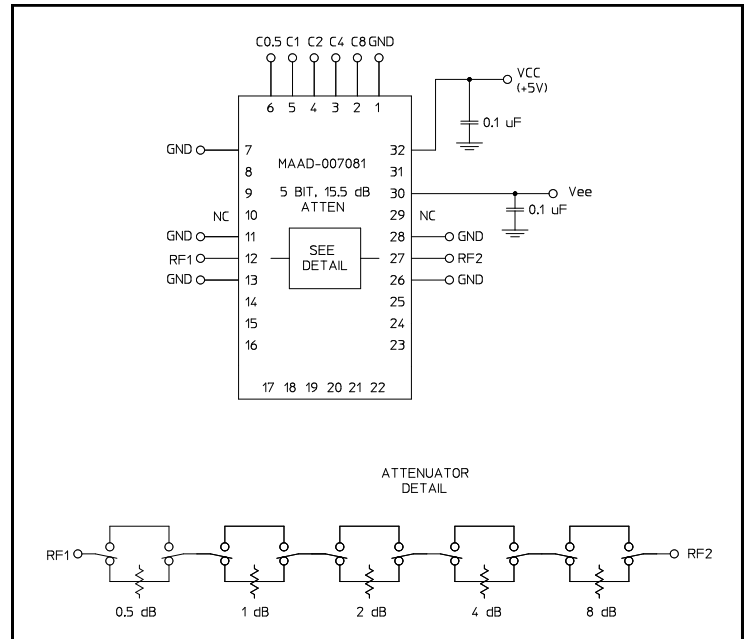

Pin Configuration¹

| Pin No. | Function | Pin No. | Function |
|---------|-----------------|---------|-----------------|
| 1 | GND | 17 | NC |
| 2 | C8 | 18 | NC |
| 3 | C4 | 19 | NC |
| 4 | C2 | 20 | NC |
| 5 | C1 | 21 | NC |
| 6 | C0.5 | 22 | NC |
| 7 | GND | 23 | NC |
| 8 | NC | 24 | NC |
| 9 | NC | 25 | NC |
| 10 | NC ² | 26 | GND |
| 11 | GND | 27 | RF2 |
| 12 | RF1 | 28 | GND |
| 13 | GND | 29 | NC ² |
| 14 | NC | 30 | -Vee |
| 15 | NC | 31 | NC |
| 16 | NC | 32 | +Vcc |

Ordering Information

| Part Number | Package |
|--------------------|-------------------|
| MAAD-007081-000100 | Bulk Packaging |
| MAAD-007081-0001TR | 1000 piece reel |
| MAAD-007081-0001TB | Sample Test Board |

Note: Reference Application Note M513 for reel size information.

* Restrictions on Hazardous Substances, European Union Directive 2002/95/EC.

1. The exposed pad centered on the package bottom must be connected to RF and DC ground. (For PQFN Packages)
2. Pins 10 & 29 must be isolated

Digital Attenuator 15.5 dB, 5-Bit, TTL Driver, DC-3.5 GHz

Rev. V4

Electrical Specifications: $T_A = 25^\circ\text{C}$, $Z_0 = 50\Omega$

| Parameter | Test Conditions | Frequency | Units | Min | Typ | Max |
|---|--|---------------|--------------------|------|-------|-----------------------------------|
| Insertion Loss | — | DC - 3.5 GHz | dB | — | 2.8 | 3.2 |
| Attenuation Accuracy | Individual Bits 0.5-1-4-8 dB Individual Bit 2 dB Any Combination of Bits 1 to 15.5 dB | DC - 3.5 GHz | dB | — | — | $\pm(.3 + 5\%$ of atten setting) |
| | | DC - 3.5 GHz | dB | — | — | $\pm(.4 + 10\%$ of atten setting) |
| | | DC - 3.5 GHz | dB | — | — | $\pm(.5 + 7\%$ of atten setting) |
| VSWR | Full Range | DC - 3.5 GHz | Ratio | — | 1.6:1 | 1.8:1 |
| Switching Speed | 50% Cntl to 90%/10% RF 10% to 90% or 90% to 10% | — | ns | — | 75 | 150 |
| | | — | ns | — | 20 | 50 |
| 1 dB Compression | — | 50 MHz | dBm | — | +21 | — |
| | | 0.5 - 3.5 GHz | dBm | — | +29 | — |
| Input IP_3 | Two-tone inputs up to +5 dBm | 50 MHz | dB | — | +35 | — |
| | | 0.5-3.5 GHz | dB | — | +48 | — |
| V_{CC} | — | — | V | 4.75 | 5.0 | 5.25 |
| V_{EE} | — | — | V | -8.0 | -5.0 | -4.75 |
| V_{IL} | LOW-level input voltage | — | V | 0.0 | — | 0.8 |
| V_{IH} | HIGH-level input voltage | — | V | 2.0 | — | 5.0 |
| I_{in} (Input Leakage Current) | $V_{in} = V_{CC}$ or GND | — | μA | -1.0 | — | 1.0 |
| I_{CC} (Quiescent Supply Current) | $V_{cntrl} = V_{CC}$ or GND | — | μA | — | 250 | 400 |
| ΔI_{CC} (Additional Supply Current Per TTL Input Pin) | $V_{CC} = \text{Max}$, $V_{cntrl} = V_{CC} - 2.1 \text{ V}$ | — | mA | — | — | 1.0 |
| I_{EE} | V_{EE} min to max, $V_{in} = V_{IL}$ or V_{IH} | — | mA | -1.0 | -0.2 | — |
| Thermal Resistance θ_{jc} | — | — | $^\circ\text{C/W}$ | — | 15 | — |

Absolute Maximum Ratings ^{3,4}

| Parameter | Absolute Maximum |
|---|---|
| Max. Input Power 0.05 GHz 0.5 - 3.5 GHz | +27 dBm +34 dBm |
| V_{CC} | $-0.5V \leq V_{CC} \leq +7.0V$ |
| V_{EE} | $-8.5V \leq V_{EE} \leq +0.5V$ |
| $V_{CC} - V_{EE}$ | $-0.5V \leq V_{CC} - V_{EE} \leq 14.5V$ |
| V_{in}^5 | $-0.5V \leq V_{in} \leq V_{CC} + 0.5V$ |
| Operating Temperature | -40°C to +85°C |
| Storage Temperature | -65°C to +125°C |

- Exceeding any one or combination of these limits may cause permanent damage to this device.
- M/A-COM does not recommend sustained operation near these survivability limits.
- Standard CMOS TTL interface, latch-up will occur if logic signal is applied prior to power supply.

Recommended PCB Configuration ⁶

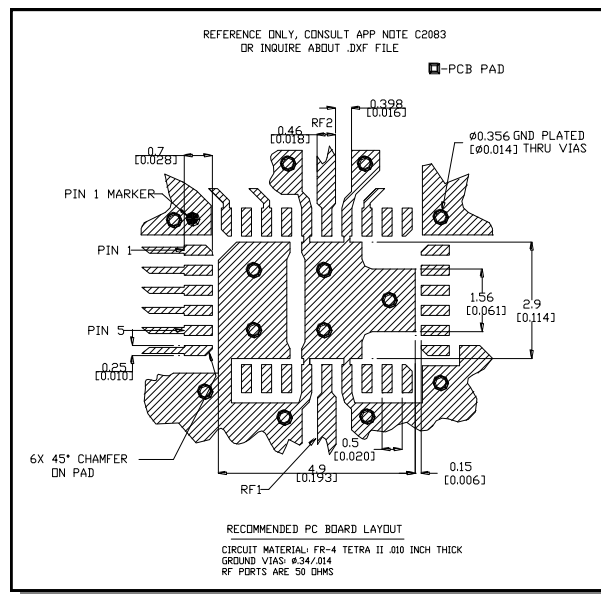

- Application Note C2083 is available on line at www.macom.com

Handling Procedures

Please observe the following precautions to avoid damage:

Static Sensitivity

Gallium Arsenide Integrated Circuits are sensitive to electrostatic discharge (ESD) and can be damaged by static electricity. Proper ESD control techniques should be used when handling these devices.

Moisture Sensitivity

The MSL rating for this part is defined as Level 2 per IPC/JEDEC J-STD-020. Parts shall be stored and/or baked as required for MSL Level 2 parts.

Truth Table (Digital Attenuator)

| C8 | C4 | C2 | C1 | C0.5 | Attenuation |
|----|----|----|----|------|-----------------|
| 0 | 0 | 0 | 0 | 0 | Loss, Reference |
| 0 | 0 | 0 | 0 | 1 | 0.5 dB |
| 0 | 0 | 0 | 1 | 0 | 1.0 dB |
| 0 | 0 | 1 | 0 | 0 | 2.0 dB |
| 0 | 1 | 0 | 0 | 0 | 4.0 dB |
| 1 | 0 | 0 | 0 | 0 | 8.0 dB |
| 1 | 1 | 1 | 1 | 1 | 15.5 dB |

0 = TTL Low; 1 = TTL High

Typical Performance Curves

Insertion Loss

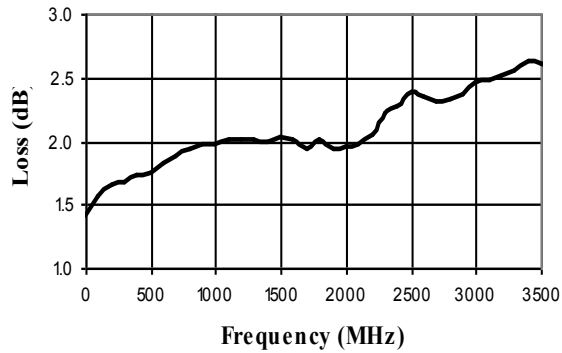

VSWR @ Insertion Loss

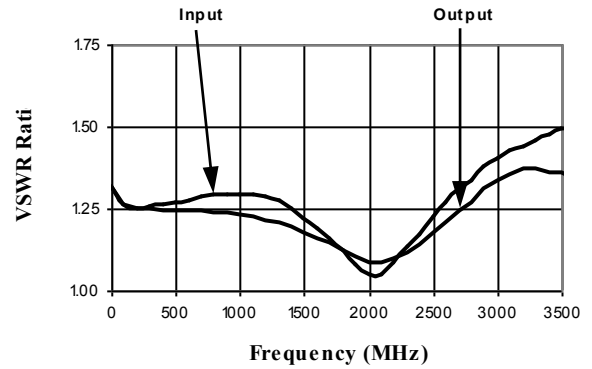

Attenuation Error, 0.5 dB Bit

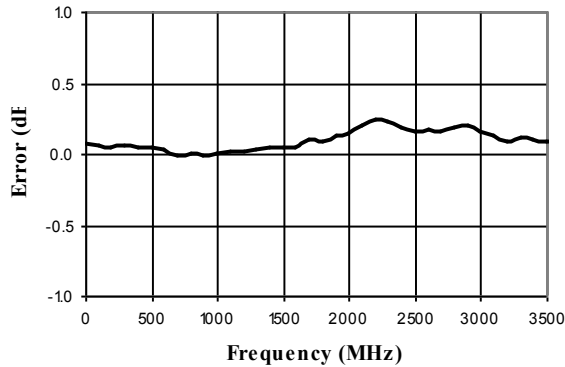

Attenuation Error, 1 dB Bit

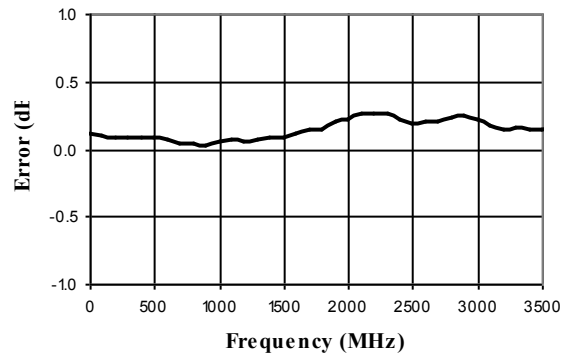

Attenuation Error, 2 dB Bit

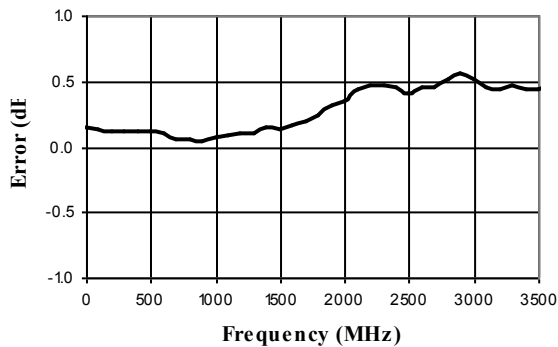

Attenuation Error, 4 dB Bit

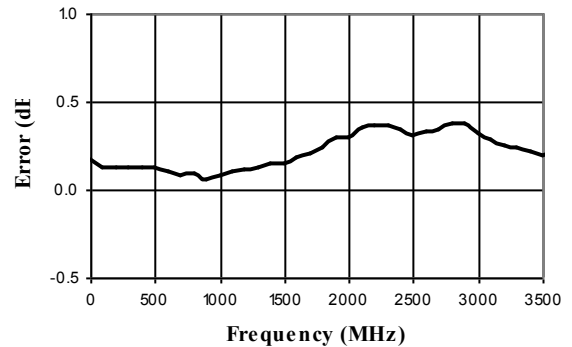

Typical Performance Curves

Attenuation Error, 8 dB Bit

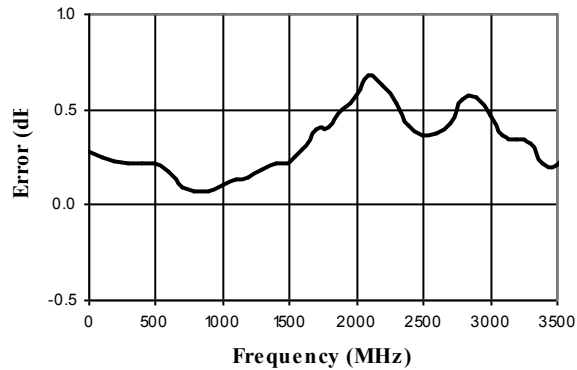

Attenuation Error, Max. Attenuation

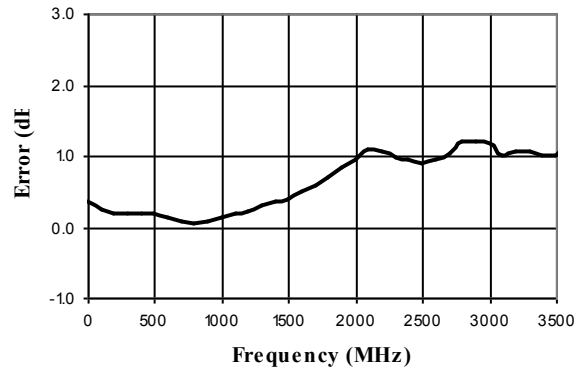

VSWR, 0.5 dB Bit

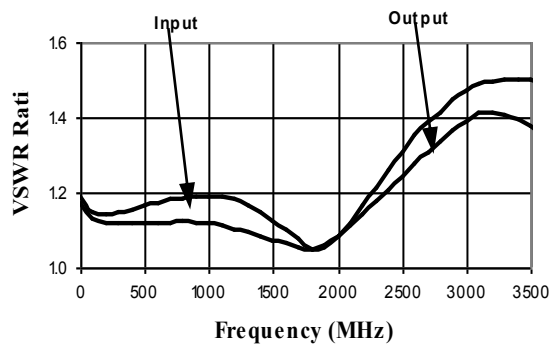

VSWR, 1 dB Bit

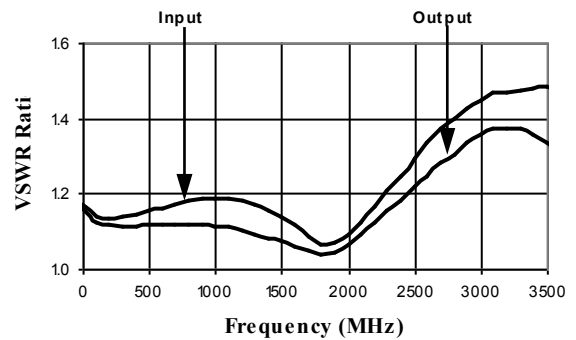

Typical Performance Curves

VSWR, 2 dB Bit

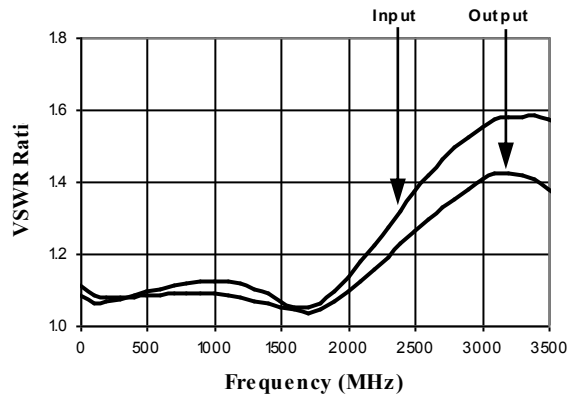

VSWR, 4 dB Bit

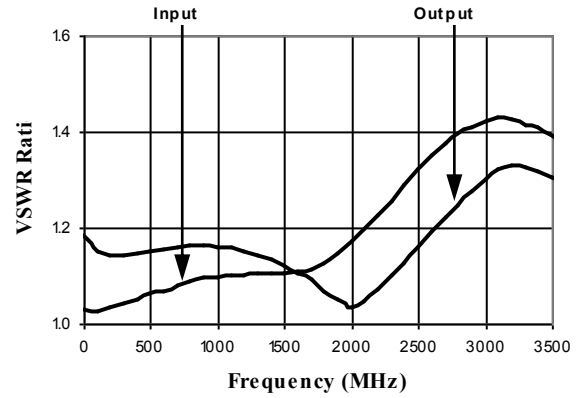

VSWR, 8 dB Bit

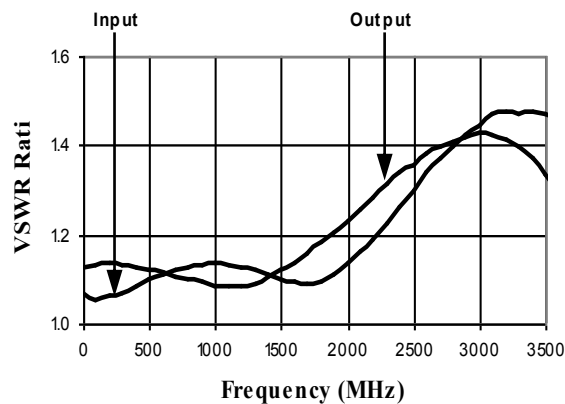

VSWR, Maximum Attenuation

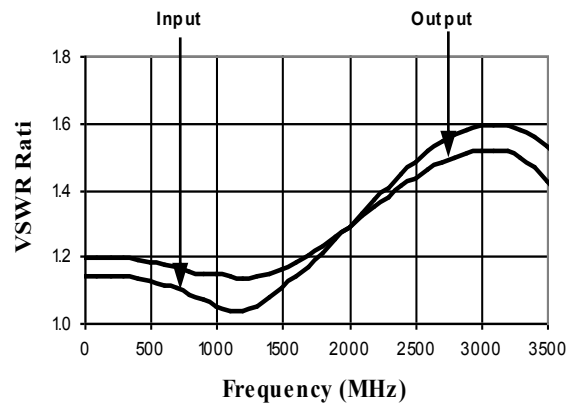

Digital Attenuator
15.5 dB, 5-Bit, TTL Driver, DC-3.5 GHz

Rev. V4

CSP-1, Lead-Free 4 x 6 mm, 32-lead
PQFN†

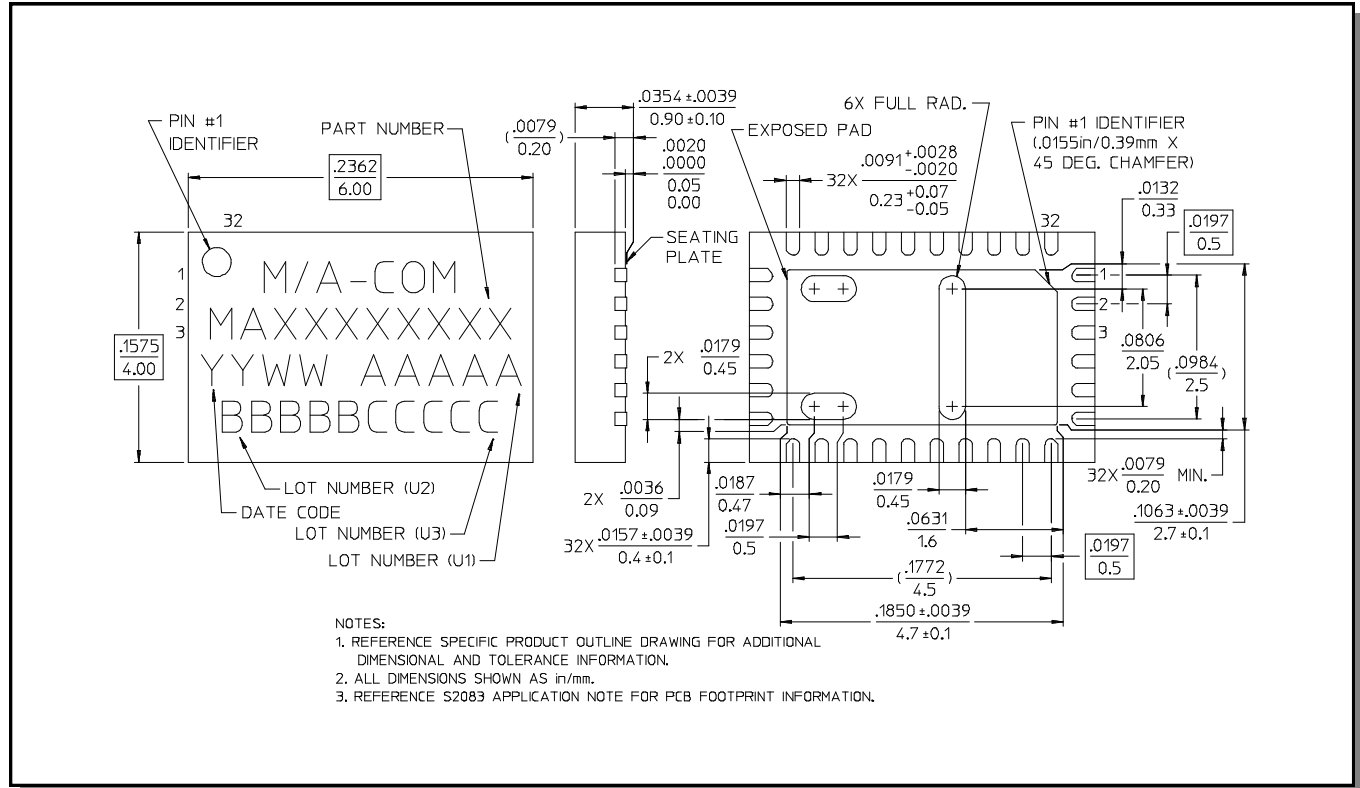

† Reference Application Note M538 for lead-free solder reflow recommendations.

M/A-COM Technology Solutions Inc. All rights reserved.

Information in this document is provided in connection with M/A-COM Technology Solutions Inc ("MACOM") products. These materials are provided by MACOM as a service to its customers and may be used for informational purposes only. Except as provided in MACOM's Terms and Conditions of Sale for such products or in any separate agreement related to this document, MACOM assumes no liability whatsoever. MACOM assumes no responsibility for errors or omissions in these materials. MACOM may make changes to specifications and product descriptions at any time, without notice. MACOM makes no commitment to update the information and shall have no responsibility whatsoever for conflicts or incompatibilities arising from future changes to its specifications and product descriptions. No license, express or implied, by estoppel or otherwise, to any intellectual property rights is granted by this document.

THESE MATERIALS ARE PROVIDED "AS IS" WITHOUT WARRANTY OF ANY KIND, EITHER EXPRESS OR IMPLIED, RELATING TO SALE AND/OR USE OF MACOM PRODUCTS INCLUDING LIABILITY OR WARRANTIES RELATING TO FITNESS FOR A PARTICULAR PURPOSE, CONSEQUENTIAL OR INCIDENTAL DAMAGES, MERCHANTABILITY, OR INFRINGEMENT OF ANY PATENT, COPYRIGHT OR OTHER INTELLECTUAL PROPERTY RIGHT. MACOM FURTHER DOES NOT WARRANT THE ACCURACY OR COMPLETENESS OF THE INFORMATION, TEXT, GRAPHICS OR OTHER ITEMS CONTAINED WITHIN THESE MATERIALS. MACOM SHALL NOT BE LIABLE FOR ANY SPECIAL, INDIRECT, INCIDENTAL, OR CONSEQUENTIAL DAMAGES, INCLUDING WITHOUT LIMITATION, LOST REVENUES OR LOST PROFITS, WHICH MAY RESULT FROM THE USE OF THESE MATERIALS.

MACOM products are not intended for use in medical, lifesaving or life sustaining applications. MACOM customers using or selling MACOM products for use in such applications do so at their own risk and agree to fully indemnify MACOM for any damages resulting from such improper use or sale.

8

M/A-COM Technology Solutions Inc. (MACOM) and its affiliates reserve the right to make changes to the product(s) or information contained herein without notice.
Visit www.macom.com for additional data sheets and product information.