

SPECIFICATION

SPEC. No. C-150°C-b

D A T E : 2016 Oct.

To

Non-Controlled Copy

CUSTOMER'S PRODUCT NAME

TDK'S PRODUCT NAME

Multilayer Ceramic Chip Capacitors
C Series/ Commercial grade
High Temperature Application

Please return this specification to TDK representatives with your signature.
If orders are placed without returned specification, please allow us to judge that specification is accepted by your side.

RECEIPT CONFIRMATION

DATE: _____ YEAR _____ MONTH _____ DAY _____

TDK Corporation
Sales
Electronic Components
Sales & Marketing Group

Engineering
Electronic Components Business Company
Ceramic Capacitors Business Group

APPROVED	Person in charge

APPROVED	CHECKED	Person in charge

1. SCOPE

This specification is applicable to chip type multilayer ceramic capacitors with a priority over the other relevant specifications.

Production places defined in this specification shall be TDK Corporation Japan, TDK (Suzhou) Co., Ltd and TDK Components U.S.A. Inc.

EXPLANATORY NOTE:

This specification warrants the quality of the ceramic chip capacitors. The chips should be evaluated or confirmed a state of mounted on your product.

If the use of the chips goes beyond the bounds of the specification, we can not afford to guarantee.

2. CODE CONSTRUCTION

(Example)

Catalog Number:	<u>C1005</u>	<u>X8R</u>	<u>1E</u>	<u>103</u>	<u>K</u>	<u>050</u>	<u>A</u>	<u>A</u>
(Web)	(1)	(2)	(3)	(4)	(5)	(6)	(7)	(8)
Item Description:	<u>C1005</u>	<u>X8R</u>	<u>1E</u>	<u>103</u>	<u>K</u>	<u>T</u>	<u>xxxx</u>	
	(1)	(2)	(3)	(4)	(5)	(9)	(10)	

(1) Type

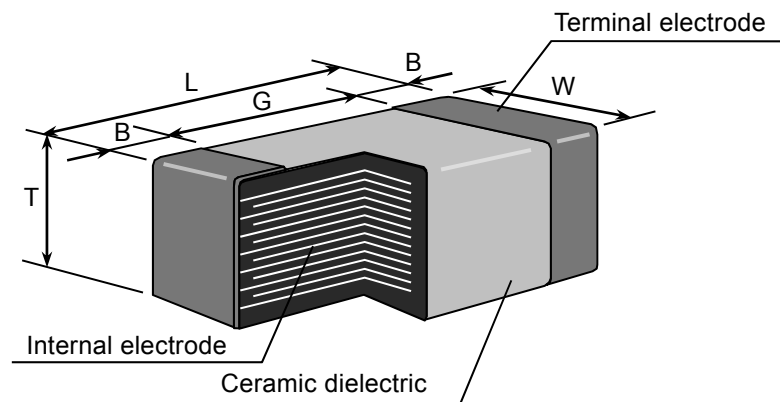

*As for dimensions of each product, please refer to detailed information on TDK web.

(2) Temperature Characteristics (Details are shown in table 1 No.7 and No.8 at page 5)

(3) Rated Voltage

Symbol	Rated Voltage
2 J	DC 630 V
2 W	DC 450 V
2 E	DC 250 V
2 A	DC 100 V
1 H	DC 50 V
1 E	DC 25 V
1 C	DC 16 V

(4) Rated Capacitance

Stated in three digits and in units of pico farads (pF).

The first and second digits identify the first and second significant figures of the capacitance, the third digit identifies the multiplier.

R is designated for a decimal point.

Example 2R2 → 2.2pF

105 → 1,000,000pF = 1.0 μF

(5) Capacitance tolerance

Symbol	Tolerance	Capacitance
C	± 0.25 pF	10pF and under
D	± 0.5 pF	
J	± 5 %	Over 10pF
K	± 10 %	
M	± 20 %	

(6) Thickness code (Only catalog number)

(7) Package code (Only catalog number)

(8) Special code (Only catalog number)

(9) Packaging (Only item description)
*Bulk is not applicable for C1005 type.

Symbol	Packaging
B	Bulk
T	Taping

(10) Internal code (Only item description)

3. RATED CAPACITANCE AND CAPACITANCE TOLERANCE

3.1 Standard combination of rated capacitance and tolerances

Class	Temperature Characteristics	Capacitance tolerance		Rated capacitance
		Capacitance	Tolerance	
1	NP0	10pF and under	C (±0.25pF)	1, 1.5, 2, 2.2, 3, 3.3, 4, 4.7, 5
			D (±0.5pF)	6, 6.8, 7, 8, 9, 10
		12pF to 10,000pF	J (± 5 %)	E – 12 series
			K (± 10 %)	E – 6 series
2	X8R	K (± 10 %) M (± 20 %)		E – 6 series

3.2 Capacitance Step in E series

E series	Capacitance Step											
E-6	1.0	1.5	2.2	3.3	4.7	6.8						
E-12	1.0	1.2	1.5	1.8	2.2	2.7	3.3	3.9	4.7	5.6	6.8	8.2

4. OPERATING TEMPERATURE RANGE

T.C.	Min. operating Temperature	Max. operating Temperature	Reference Temperature
NP0, X8R	-55°C	150°C	25°C

5. STORING CONDITION AND TERM

5 to 40°C at 20 to 70%RH

6 months Max.

6. P.C. BOARD

When mounting on an aluminum substrate, large case sizes such as C3225, C4532 and C5750 types are more likely to be affected by heat stress from the substrate.

Please inquire separate specification for the large case sizes when mounted on the substrate.

7. INDUSTRIAL WASTE DISPOSAL

Dispose this product as industrial waste in accordance with the Industrial Waste Law.

8. PERFORMANCE

table 1

No.	Item	Performance	Test or inspection method																	
1	External Appearance	No defects which may affect performance.	Inspect with magnifying glass (3×).																	
2	Insulation Resistance	10,000MΩ or 500MΩ·μF min. (As for the capacitors of rated voltage 16V DC, 10,000MΩ or 100MΩ·μF min.) whichever smaller.	Apply rated voltage for 60s. As for the capacitor of rated voltage 630V DC, apply 500V DC.																	
3	Voltage Proof	Withstand test voltage without insulation breakdown or other damage.	<table border="1"> <thead> <tr> <th>T.C.</th> <th>Rated voltage(RV)</th> <th>Apply voltage</th> </tr> </thead> <tbody> <tr> <td rowspan="3">NP0</td> <td>$RV \leq 100V$</td> <td>3 × rated voltage</td> </tr> <tr> <td>$100V < RV \leq 500V$</td> <td>1.5 × rated voltage</td> </tr> <tr> <td>$500V < RV$</td> <td>1.3 × rated voltage</td> </tr> <tr> <td rowspan="3">X8R</td> <td>$RV \leq 100V$</td> <td>2.5 × rated voltage</td> </tr> <tr> <td>$100V < RV \leq 500V$</td> <td>1.5 × rated voltage</td> </tr> <tr> <td>$500V < RV$</td> <td>1.3 × rated voltage</td> </tr> </tbody> </table> <p>Above DC voltage shall be applied for 1s. Charge / discharge current shall not exceed 50mA.</p>	T.C.	Rated voltage(RV)	Apply voltage	NP0	$RV \leq 100V$	3 × rated voltage	$100V < RV \leq 500V$	1.5 × rated voltage	$500V < RV$	1.3 × rated voltage	X8R	$RV \leq 100V$	2.5 × rated voltage	$100V < RV \leq 500V$	1.5 × rated voltage	$500V < RV$	1.3 × rated voltage
T.C.	Rated voltage(RV)	Apply voltage																		
NP0	$RV \leq 100V$	3 × rated voltage																		
	$100V < RV \leq 500V$	1.5 × rated voltage																		
	$500V < RV$	1.3 × rated voltage																		
X8R	$RV \leq 100V$	2.5 × rated voltage																		
	$100V < RV \leq 500V$	1.5 × rated voltage																		
	$500V < RV$	1.3 × rated voltage																		
4	Capacitance	Within the specified tolerance.	<table border="1"> <thead> <tr> <th>T.C.</th> <th>Rated Capacitance</th> <th>Measuring frequency</th> <th>Measuring voltage</th> </tr> </thead> <tbody> <tr> <td rowspan="2">NP0</td> <td>1000pF and under</td> <td>1MHz±10%</td> <td rowspan="2">0.5~5Vrms.</td> </tr> <tr> <td>Over 1000pF</td> <td>1kHz±10%</td> </tr> <tr> <td>X8R</td> <td>All</td> <td>1kHz±10%</td> <td>1.0±0.2Vrms</td> </tr> </tbody> </table> <p>For information which product has which measuring voltage, please contact with our sales representative.</p>	T.C.	Rated Capacitance	Measuring frequency	Measuring voltage	NP0	1000pF and under	1MHz±10%	0.5~5Vrms.	Over 1000pF	1kHz±10%	X8R	All	1kHz±10%	1.0±0.2Vrms			
T.C.	Rated Capacitance	Measuring frequency	Measuring voltage																	
NP0	1000pF and under	1MHz±10%	0.5~5Vrms.																	
	Over 1000pF	1kHz±10%																		
X8R	All	1kHz±10%	1.0±0.2Vrms																	
5	Q (NP0)	<table border="1"> <thead> <tr> <th>Rated capacitance</th> <th>Q</th> </tr> </thead> <tbody> <tr> <td>30pF and over</td> <td>1000 min.</td> </tr> <tr> <td>Under 30pF</td> <td>400+20xC min.</td> </tr> </tbody> </table> <p>C: Rated capacitance (pF)</p>	Rated capacitance	Q	30pF and over	1000 min.	Under 30pF	400+20xC min.	See No.4 in this table for measuring condition.											
Rated capacitance	Q																			
30pF and over	1000 min.																			
Under 30pF	400+20xC min.																			
6	Dissipation Factor (X8R)	As for D.F. spec of each product, please refer to detailed information on TDK web.	See No.4 in this table for measuring condition.																	

(continued)

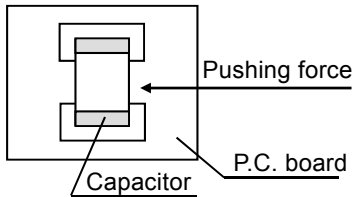
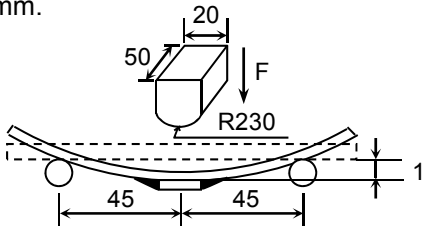
No.	Item	Performance	Test or inspection method													
7	Temperature Characteristics of Capacitance (NP0)	<table border="1" style="width: 100%; text-align: center;"> <tr> <td>Temperature Coefficient (ppm/°C)</td> </tr> <tr> <td>0 ± 30</td> </tr> </table> <p>Capacitance drift Within $\pm 0.2\%$ or $\pm 0.05\text{pF}$, whichever larger.</p>	Temperature Coefficient (ppm/°C)	0 ± 30	<p>Temperature coefficient shall be calculated based on values at 25°C and 85°C temperature.</p> <p>Measuring temperature below 20°C shall be -10°C and -25°C.</p>											
Temperature Coefficient (ppm/°C)																
0 ± 30																
8	Temperature Characteristics of Capacitance (X8R)	<table border="1" style="width: 100%; text-align: center;"> <tr> <td>Capacitance Change (%)</td> </tr> <tr> <td>No voltage applied</td> </tr> <tr> <td>$\pm 15(\%)$</td> </tr> </table>	Capacitance Change (%)	No voltage applied	$\pm 15(\%)$	<p>Capacitance shall be measured by the steps shown in the following table after thermal equilibrium is obtained for each step.</p> <p>ΔC be calculated ref. STEP3 reading</p> <table border="1" style="width: 100%; text-align: center;"> <thead> <tr> <th>Step</th> <th>Temperature(°C)</th> </tr> </thead> <tbody> <tr> <td>1</td> <td>25 ± 2</td> </tr> <tr> <td>2</td> <td>-55 ± 2</td> </tr> <tr> <td>3</td> <td>25 ± 2</td> </tr> <tr> <td>4</td> <td>150 ± 2</td> </tr> </tbody> </table>	Step	Temperature(°C)	1	25 ± 2	2	-55 ± 2	3	25 ± 2	4	150 ± 2
Capacitance Change (%)																
No voltage applied																
$\pm 15(\%)$																
Step	Temperature(°C)															
1	25 ± 2															
2	-55 ± 2															
3	25 ± 2															
4	150 ± 2															
9	Robustness of Terminations	No sign of termination coming off, breakage of ceramic, or other abnormal signs.	<p>Reflow solder the capacitors on a P.C. board shown in Appendix2 and apply a pushing force of 2N (C1005) or 5N (C1608, C2012, C3216, C3225, C4532, C5750) with 10±1s.</p>  <p>The diagram shows a top-down view of a capacitor mounted on a P.C. board. A horizontal arrow labeled 'Pushing force' points to the right, applied to the top surface of the capacitor. The capacitor is labeled 'Capacitor' and the board is labeled 'P.C. board'.</p>													
10	Bending	No mechanical damage.	<p>Reflow solder the capacitors on a P.C. board shown in Appendix1 and bend it for 1mm.</p>  <p>The diagram shows a side view of a capacitor on a P.C. board being bent. The capacitor has a length of 50 mm and a width of 20 mm. A downward force 'F' is applied to its top surface. The board is supported by two points, each 45 mm from the center of the capacitor. The board is bent with a radius of R230. The final bend height is 1 mm. The unit is mm.</p>													

(continued)

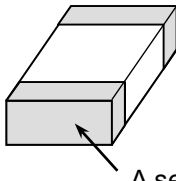
No.	Item	Performance	Test or inspection method																						
11	Solderability	<p>New solder to cover over 75% of termination. 25% may have pin holes or rough spots but not concentrated in one spot. Ceramic surface of A sections shall not be exposed due to melting or shifting of termination material.</p>  <p style="text-align: center;">A section</p>	<p>Completely soak both terminations in solder at the following conditions.</p> <p>Solder : Sn-3.0Ag-0.5Cu or Sn-37Pb Temperature : 245±5°C(Sn-3.0Ag-0.5Cu) 235±5°C(Sn-37Pb) Soaking time : 3±0.3s(Sn-3.0Ag-0.5Cu) 2±0.2s(Sn-37Pb)</p> <p>Flux: Isopropyl alcohol (JIS K 8839) Rosin (JIS K 5902) 25% solid solution.</p>																						
12	Resistance to solder heat	<table border="1" style="width: 100%; border-collapse: collapse;"> <tr> <td data-bbox="336 779 509 913">External appearance</td> <td colspan="2" data-bbox="509 779 956 913">No cracks are allowed and terminations shall be covered at least 60% with new solder.</td> </tr> <tr> <td data-bbox="336 913 509 1317" rowspan="3">Capacitance</td> <td data-bbox="509 913 719 1016">Characteristics</td> <td data-bbox="719 913 956 1016">Change from the value before test</td> </tr> <tr> <td data-bbox="509 1016 719 1144">NP0</td> <td data-bbox="719 1016 956 1144">Capacitance drift within ±2.5% or ±0.25pF, whichever larger.</td> </tr> <tr> <td data-bbox="509 1144 719 1317">X8R</td> <td data-bbox="719 1144 956 1317">± 7.5 %</td> </tr> <tr> <td data-bbox="336 1317 509 1464">Q (NP0)</td> <td colspan="2" data-bbox="509 1317 956 1464">Meet the initial spec.</td> </tr> <tr> <td data-bbox="336 1464 509 1585">D.F. (X8R)</td> <td colspan="2" data-bbox="509 1464 956 1585">Meet the initial spec.</td> </tr> <tr> <td data-bbox="336 1585 509 1666">Insulation Resistance</td> <td colspan="2" data-bbox="509 1585 956 1666">Meet the initial spec.</td> </tr> <tr> <td data-bbox="336 1666 509 1751">Voltage proof</td> <td colspan="2" data-bbox="509 1666 956 1751">No insulation breakdown or other damage.</td> </tr> </table>	External appearance	No cracks are allowed and terminations shall be covered at least 60% with new solder.		Capacitance	Characteristics	Change from the value before test	NP0	Capacitance drift within ±2.5% or ±0.25pF, whichever larger.	X8R	± 7.5 %	Q (NP0)	Meet the initial spec.		D.F. (X8R)	Meet the initial spec.		Insulation Resistance	Meet the initial spec.		Voltage proof	No insulation breakdown or other damage.		<p>Completely soak both terminations in solder at the following conditions. 260±5°C for 10±1s.</p> <p>Preheating condition Temp.: 110 ~ 140°C Time : 30 ~ 60s.</p> <p>Solder : Sn-3.0Ag-0.5Cu or Sn-37Pb</p> <p>Flux : Isopropyl alcohol (JIS K 8839) Rosin (JIS K 5902) 25% solid solution.</p> <p>Leave the capacitors in ambient condition for 6 to 24h (Class1) or 24±2h (Class2) before measurement.</p>
External appearance	No cracks are allowed and terminations shall be covered at least 60% with new solder.																								
Capacitance	Characteristics	Change from the value before test																							
	NP0	Capacitance drift within ±2.5% or ±0.25pF, whichever larger.																							
	X8R	± 7.5 %																							
Q (NP0)	Meet the initial spec.																								
D.F. (X8R)	Meet the initial spec.																								
Insulation Resistance	Meet the initial spec.																								
Voltage proof	No insulation breakdown or other damage.																								

(continued)

No.	Item		Performance	Test or inspection method															
13	Vibration	External appearance	No mechanical damage.	<p>Reflow solder the capacitors on a P.C. board shown in Appendix2 before testing.</p> <p>Vibrate the capacitors with amplitude of 1.5mm P-P changing the frequencies from 10Hz to 55Hz and back to 10Hz in about 1min.</p> <p>Repeat this for 2h each in 3 perpendicular directions.</p>															
		Capacitance	Characteristics		Change from the value before test														
			NP0		$\pm 2.5\%$ or $\pm 0.25\text{pF}$, whichever larger.														
			X8R		$\pm 7.5\%$														
		Q (NP0)	Meet the initial spec.																
D.F. (X8R)	Meet the initial spec.																		
14	Temperature cycle	External appearance	No mechanical damage.	<p>Reflow solder the capacitors on a P.C. board shown in Appendix2 before testing.</p> <p>Expose the capacitors in the condition step1 through step 4 and repeat 5 times consecutively.</p> <p>Leave the capacitors in ambient condition for 6 to 24h (Class 1) or 24\pm2h (Class 2) before measurement.</p> <table border="1"> <thead> <tr> <th>Step</th> <th>Temperature(°C)</th> <th>Time (min.)</th> </tr> </thead> <tbody> <tr> <td>1</td> <td>-55 \pm 3</td> <td>30 \pm 3</td> </tr> <tr> <td>2</td> <td>25</td> <td>2 - 5</td> </tr> <tr> <td>3</td> <td>150 \pm 2</td> <td>30 \pm 2</td> </tr> <tr> <td>4</td> <td>25</td> <td>2 - 5</td> </tr> </tbody> </table>	Step	Temperature(°C)	Time (min.)	1	-55 \pm 3	30 \pm 3	2	25	2 - 5	3	150 \pm 2	30 \pm 2	4	25	2 - 5
		Step	Temperature(°C)		Time (min.)														
		1	-55 \pm 3		30 \pm 3														
		2	25		2 - 5														
		3	150 \pm 2		30 \pm 2														
		4	25		2 - 5														
		Capacitance	Characteristics		Change from the value before test														
NP0	$\pm 2.5\%$ or $\pm 0.25\text{pF}$, whichever larger.																		
X8R	$\pm 7.5\%$																		
Q (NP0)	Meet the initial spec.																		
D.F. (X8R)	Meet the initial spec.																		
Insulation Resistance	Meet the initial spec.																		
Voltage proof	No insulation breakdown or other damage.																		

(continued)

No.	Item	Performance	Test or inspection method								
15	Moisture Resistance (Steady State)	External appearance	No mechanical damage.	Reflow solder the capacitors on a P.C. board shown in Appendix2 before testing. Leave at temperature $40 \pm 2^{\circ}\text{C}$, 90 to 95%RH for 500 +24,0h. Leave the capacitors in ambient condition for 6 to 24h (Class1) or $24 \pm 2\text{h}$ (Class2) before measurement.							
		Capacitance	<table border="1"> <tr> <th data-bbox="555 315 711 383">Characteristics</th> <th data-bbox="743 315 963 383">Change from the value before test</th> </tr> <tr> <td data-bbox="555 383 743 450">NP0</td> <td data-bbox="743 383 963 450">$\pm 5\%$ or $\pm 0.5\text{pF}$, whichever larger.</td> </tr> <tr> <td data-bbox="555 450 743 573">X8R</td> <td data-bbox="743 450 963 573">$\pm 12.5\%$</td> </tr> </table>		Characteristics	Change from the value before test	NP0	$\pm 5\%$ or $\pm 0.5\text{pF}$, whichever larger.	X8R	$\pm 12.5\%$	
			Characteristics		Change from the value before test						
			NP0		$\pm 5\%$ or $\pm 0.5\text{pF}$, whichever larger.						
	X8R	$\pm 12.5\%$									
<table border="1"> <tr> <th data-bbox="555 618 775 663">Rated Capacitance</th> <th data-bbox="775 618 963 663">Q</th> </tr> <tr> <td data-bbox="555 663 775 707">30pF and over</td> <td data-bbox="775 663 963 707">350 min.</td> </tr> <tr> <td data-bbox="555 707 775 775">10pF and over under 30pF</td> <td data-bbox="775 707 963 775">$275+5/2 \times C$ min.</td> </tr> <tr> <td data-bbox="555 775 775 819">Under 10pF</td> <td data-bbox="775 775 963 819">$200+10 \times C$ min.</td> </tr> </table> C : Rated capacitance (pF)	Rated Capacitance	Q	30pF and over	350 min.	10pF and over under 30pF	$275+5/2 \times C$ min.	Under 10pF	$200+10 \times C$ min.			
Rated Capacitance	Q										
30pF and over	350 min.										
10pF and over under 30pF	$275+5/2 \times C$ min.										
Under 10pF	$200+10 \times C$ min.										
D.F. (X8R)		200% of initial spec. max.									
Insulation Resistance		1,000M Ω or 50M Ω · μF min. (As for the capacitors of rated voltage 16V DC, 1,000M Ω or 10M Ω · μF min.) whichever smaller.									

(continued)

No.	Item	Performance	Test or inspection method							
16	Moisture Resistance	External appearance	No mechanical damage.							
		Capacitance	<table border="1"> <thead> <tr> <th data-bbox="555 315 746 376">Characteristics</th> <th data-bbox="746 315 975 376">Change from the value before test</th> </tr> </thead> <tbody> <tr> <td data-bbox="555 376 746 450">NP0</td> <td data-bbox="746 376 975 450">±7.5% or ±0.75pF, whichever larger.</td> </tr> <tr> <td data-bbox="555 450 746 577">X8R</td> <td data-bbox="746 450 975 577">± 12.5 %</td> </tr> </tbody> </table>	Characteristics	Change from the value before test	NP0	±7.5% or ±0.75pF, whichever larger.	X8R	± 12.5 %	<p>Reflow solder the capacitors on a P.C. board shown in Appendix2 before testing.</p> <p>Apply the rated voltage at temperature 40±2°C and 90 to 95%RH for 500 +24,0h.</p> <p>Charge/discharge current shall not exceed 50mA.</p>
	Characteristics	Change from the value before test								
	NP0	±7.5% or ±0.75pF, whichever larger.								
	X8R	± 12.5 %								
	Q (NP0)	<table border="1"> <thead> <tr> <th data-bbox="555 622 775 667">Rated Capacitance</th> <th data-bbox="775 622 975 667">Q</th> </tr> </thead> <tbody> <tr> <td data-bbox="555 667 775 712">30pF and over</td> <td data-bbox="775 667 975 712">200 min.</td> </tr> <tr> <td data-bbox="555 712 775 757">Under 30pF</td> <td data-bbox="775 712 975 757">100+10/3×C min.</td> </tr> </tbody> </table> <p>C : Rated capacitance (pF)</p>	Rated Capacitance	Q	30pF and over	200 min.	Under 30pF	100+10/3×C min.	<p>Leave the capacitors in ambient condition for 6 to 24h (Class1) or 24±2h (Class2) before measurement.</p> <p>Voltage conditioning (only for class 2)</p> <p>Voltage treat the capacitors under testing temperature and voltage for 1hour.</p>	
Rated Capacitance	Q									
30pF and over	200 min.									
Under 30pF	100+10/3×C min.									
	D.F. (X8R)	200% of initial spec. max.	<p>Leave the capacitors in ambient condition for 24±2h before measurement.</p> <p>Use this measurement for initial value.</p>							
	Insulation Resistance	500MΩ or 25MΩ·μF min. (As for the capacitors of rated voltage 16V DC, 500MΩ or 5MΩ·μF min.) whichever smaller.								

(continued)

No.	Item	Performance	Test or inspection method												
17	Life	External appearance	No mechanical damage.												
		Capacitance	<table border="1"> <tr> <td data-bbox="539 338 727 398">Characteristics</td> <td data-bbox="727 338 948 398">Change from the value before test</td> </tr> <tr> <td data-bbox="539 398 727 459">NP0</td> <td data-bbox="727 398 948 459">±3% or ±0.3pF, whichever larger.</td> </tr> <tr> <td data-bbox="539 459 727 584">X8R</td> <td data-bbox="727 459 948 584">± 15 %</td> </tr> </table>	Characteristics	Change from the value before test	NP0	±3% or ±0.3pF, whichever larger.	X8R	± 15 %	<p>Reflow solder the capacitors on a P.C. board shown in Appendix2 before testing.</p> <p>Below the voltage shall be applied at 150 ±2°C for 1,000 +48,0h.</p> <table border="1"> <tr> <td data-bbox="1023 459 1406 497">Applied Voltage</td> </tr> <tr> <td data-bbox="1023 497 1406 535">Rated voltage x2</td> </tr> <tr> <td data-bbox="1023 535 1406 573">Rated voltage x1.5</td> </tr> <tr> <td data-bbox="1023 573 1406 611">Rated voltage x1.2</td> </tr> <tr> <td data-bbox="1023 611 1406 649">Rated voltage x1</td> </tr> </table>	Applied Voltage	Rated voltage x2	Rated voltage x1.5	Rated voltage x1.2	Rated voltage x1
	Characteristics	Change from the value before test													
	NP0	±3% or ±0.3pF, whichever larger.													
	X8R	± 15 %													
Applied Voltage															
Rated voltage x2															
Rated voltage x1.5															
Rated voltage x1.2															
Rated voltage x1															
	Q (NP0)	<table border="1"> <tr> <td data-bbox="539 660 759 698">Rated Capacitance</td> <td data-bbox="759 660 948 698">Q</td> </tr> <tr> <td data-bbox="539 698 759 739">30pF and over</td> <td data-bbox="759 698 948 739">350 min.</td> </tr> <tr> <td data-bbox="539 739 759 801">10pF and over under 30pF</td> <td data-bbox="759 739 948 801">275+5/2×C min.</td> </tr> <tr> <td data-bbox="539 801 759 842">Under 10pF</td> <td data-bbox="759 801 948 842">200+10×C min.</td> </tr> </table> <p>C : Rated capacitance (pF)</p>	Rated Capacitance	Q	30pF and over	350 min.	10pF and over under 30pF	275+5/2×C min.	Under 10pF	200+10×C min.	<p>As for applied voltage, please contact with our sales representative.</p> <p>Charge/discharge current shall not exceed 50mA.</p>				
Rated Capacitance	Q														
30pF and over	350 min.														
10pF and over under 30pF	275+5/2×C min.														
Under 10pF	200+10×C min.														
	D.F. (X8R)	200% of initial spec. max.	Leave the capacitors in ambient condition for 6 to 24h (Class1) or 24±2h (Class2) before measurement.												
	Insulation Resistance	1,000MΩ or 50MΩ·μF min. (As for the capacitors of rated voltage 16V DC, 1,000MΩ or 10MΩ·μF min.) whichever smaller.	<p>Voltage conditioning (only for class 2) Voltage treat the capacitors under testing temperature and voltage for 1hour.</p> <p>Leave the capacitors in ambient condition for 24±2h before measurement.</p> <p>Use this measurement for initial value.</p>												

*As for the initial measurement of capacitors (X8R) on number 8,12,13,14 and 15, leave capacitors at 150 -10,0°C for 1 hour and measure the value after leaving capacitors for 24 ± 2h in ambient condition.

Appendix1 P.C. board for bending test

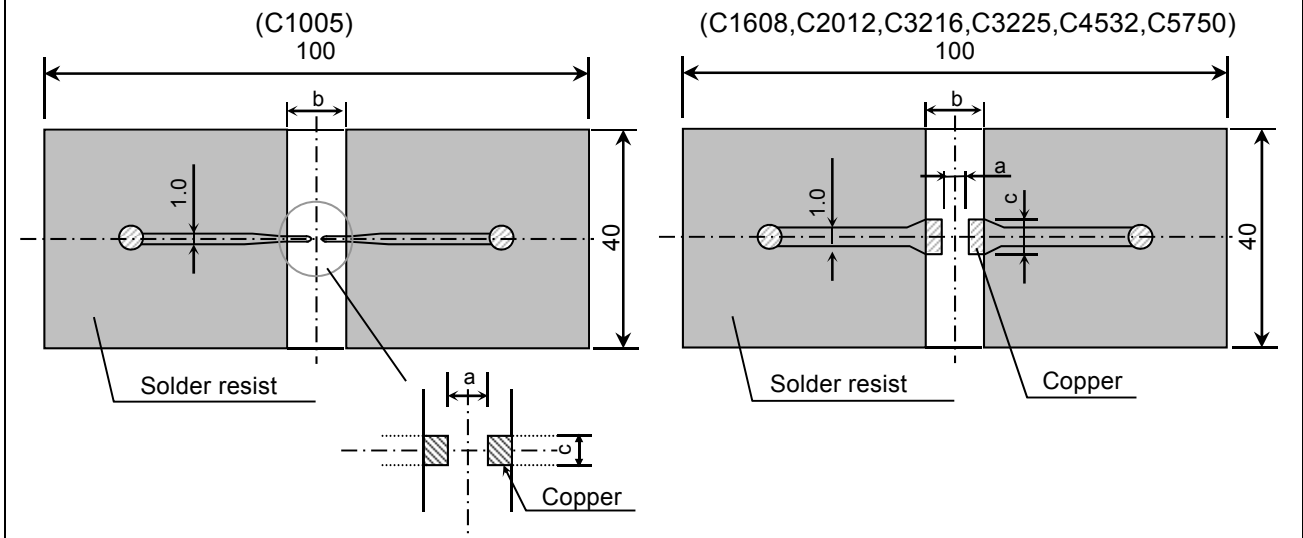

Appendix2 P.C. Board for reliability test

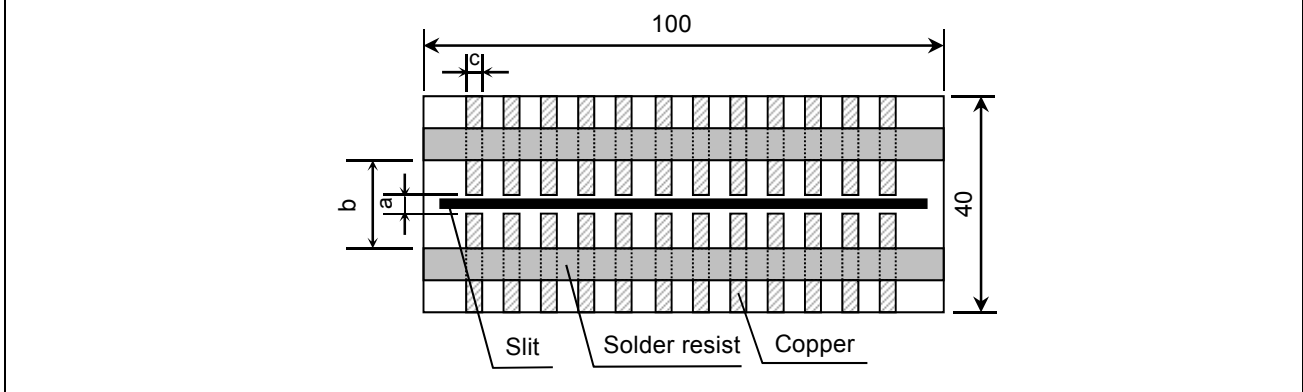

(It is recommended to provide a slit on P.C. board for C3225, C4532 and C5750.)

(Unit : mm)

Type	Dimensions		
	a	b	c
TDK(EIA style)			
C1005 (CC0402)	0.4	1.5	0.5
C1608 (CC0603)	1.0	3.0	1.2
C2012 (CC0805)	1.2	4.0	1.65
C3216 (CC1206)	2.2	5.0	2.0
C3225 (CC1210)	2.2	5.0	2.9
C4532 (CC1812)	3.5	7.0	3.7
C5750 (CC2220)	4.5	8.0	5.6

1. Material : Glass Epoxy (As per JIS C6484 GE4)

Copper(Thickness:0.035mm)
 Solder resist

2. Thickness : Appendix 1 — 0.8mm (C1005)
 — 1.6mm (C1608,C2012,C3216,C3225,C4532,C5750)
 : Appendix 2 — 1.6mm

9. INSIDE STRUCTURE AND MATERIAL

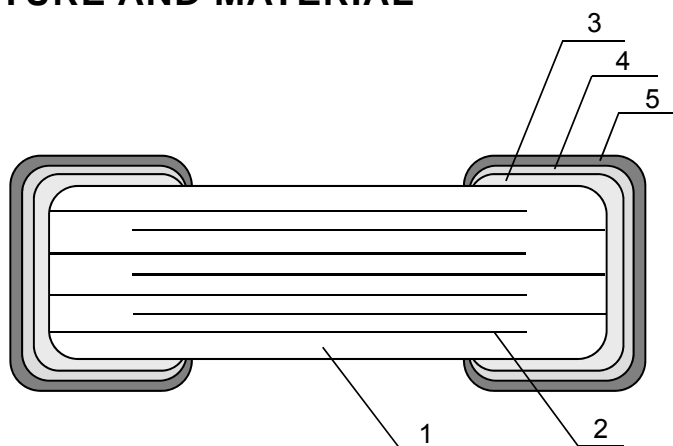

No.	NAME	MATERIAL	
		NP0	X8R
1	Dielectric	CaZrO ₃	BaTiO ₃
2	Electrode	Nickel (Ni)	
3	Termination	Copper (Cu)	
4		Nickel (Ni)	
5		Tin (Sn)	

10. PACKAGING

Packaging shall be done to protect the components from the damage during transportation and storing, and a label which has the following information shall be attached.

- 1) Total number of components in a plastic bag for bulk packaging : 1000pcs
(C1005 types are not applicable.)
- 2) Tape packaging is as per TDK tape packaging specification.

- 1) Inspection No.
- 2) TDK P/N
- 3) Customer's P/N
- 4) Quantity

*Composition of Inspection No.

Example F 6 A - 00 - 000
 (a) (b) (c) (d) (e)

- a) Line code
- b) Last digit of the year
- c) Month and A for January and B for February and so on. (Skip I)
- d) Inspection Date of the month.
- e) Serial No. of the day

11. RECOMMENDATION

As for C3225 and larger, It is recommended to provide a slit (about 1mm width) in the board under the components to improve washing Flux. And please make sure to dry detergent up completely before.

12. SOLDERING CONDITION

As for C1005, C3225, C4532 and C5750 types, reflow soldering only.

13. Caution

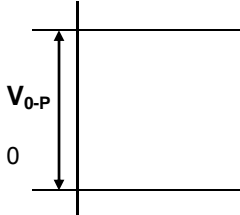
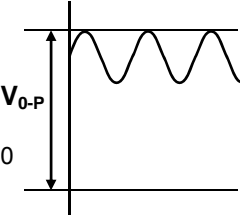
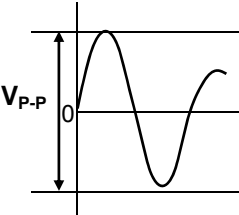
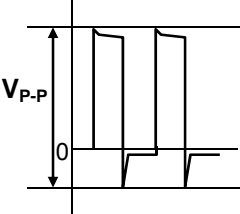
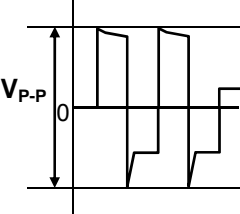
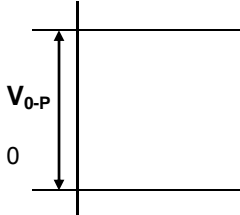
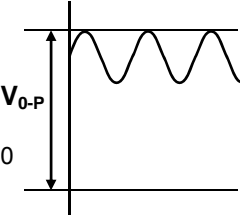
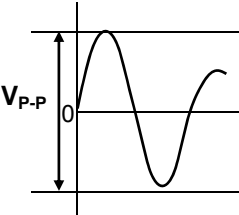
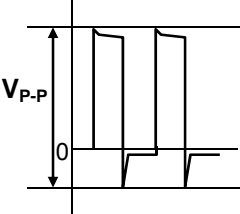
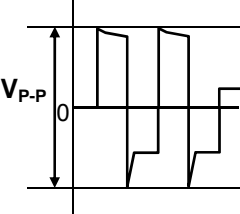
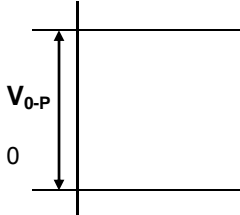
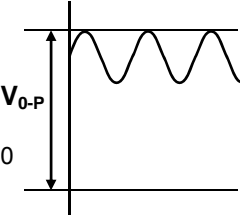
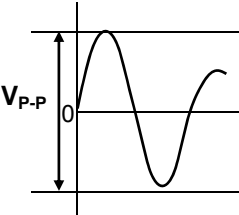
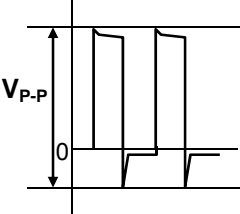
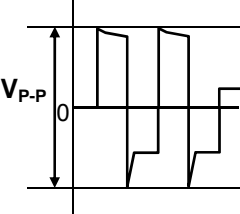
No.	Process	Condition																
1	Operating Condition (Storage, Transportation)	<p>1-1. Storage</p> <ol style="list-style-type: none"> 1) The capacitors must be stored in an ambient temperature of 5 to 40°C with a relative humidity of 20 to 70%RH. The products should be used within 6 months upon receipt. 2) The capacitors must be operated and stored in an environment free of dew condensation and these gases such as Hydrogen Sulphide, Hydrogen Sulphate, Chlorine, Ammonia and sulfur. 3) Avoid storing in sun light and falling of dew. 4) Do not use capacitors under high humidity and high and low atmospheric pressure which may affect capacitors reliability. 5) Capacitors should be tested for the solderability when they are stored for long time. <p>1-2. Handling in transportation</p> <p>In case of the transportation of the capacitors, the performance of the capacitors may be deteriorated depending on the transportation condition. (Refer to JEITA RCR-2335C 9.2 Handling in transportation)</p>																
2	Circuit design ⚠ Caution	<p>2-1. Operating temperature</p> <p>Operating temperature should be followed strictly within this specification, especially be careful with maximum temperature.</p> <ol style="list-style-type: none"> 1) Do not use capacitors above the maximum allowable operating temperature. 2) Surface temperature including self heating should be below maximum operating temperature. (Due to dielectric loss, capacitors will heat itself when AC is applied. Especially at high frequencies around its SRF, the heat might be so extreme that it may damage itself or the product mounted on. Please design the circuit so that the maximum temperature of the capacitors including the self heating to be below the maximum allowable operating temperature. Temperature rise at capacitor surface shall be below 20°C) 3) The electrical characteristics of the capacitors will vary depending on the temperature. The capacitors should be selected and designed in taking the temperature into consideration. <p>2-2. Operating voltage</p> <ol style="list-style-type: none"> 1) Operating voltage across the terminals should be below the rated voltage. When AC and DC are super imposed, V_{0-P} must be below the rated voltage. — (1) and (2) <p>AC or pulse with overshooting, V_{P-P} must be below the rated voltage. — (3), (4) and (5)</p> <p>When the voltage is started to apply to the circuit or it is stopped applying, the irregular voltage may be generated for a transit period because of resonance or switching. Be sure to use the capacitors within rated voltage containing these Irregular voltage.</p> <table border="1" data-bbox="475 1473 1445 2067"> <thead> <tr> <th data-bbox="475 1473 660 1518">Voltage</th> <th data-bbox="660 1473 922 1518">(1) DC voltage</th> <th data-bbox="922 1473 1184 1518">(2) DC+AC voltage</th> <th data-bbox="1184 1473 1445 1518">(3) AC voltage</th> </tr> </thead> <tbody> <tr> <td data-bbox="475 1518 660 1753"> Positional Measurement (Rated voltage) V_{0-P} 0 </td> <td data-bbox="660 1518 922 1753">  </td> <td data-bbox="922 1518 1184 1753">  </td> <td data-bbox="1184 1518 1445 1753">  </td> </tr> <tr> <th data-bbox="475 1783 660 1827">Voltage</th> <th data-bbox="660 1783 922 1827">(4) Pulse voltage (A)</th> <th data-bbox="922 1783 1184 1827">(5) Pulse voltage (B)</th> <td></td> </tr> <tr> <td data-bbox="475 1827 660 2067"> Positional Measurement (Rated voltage) V_{P-P} 0 </td> <td data-bbox="660 1827 922 2067">  </td> <td data-bbox="922 1827 1184 2067">  </td> <td></td> </tr> </tbody> </table>	Voltage	(1) DC voltage	(2) DC+AC voltage	(3) AC voltage	Positional Measurement (Rated voltage) V_{0-P} 0				Voltage	(4) Pulse voltage (A)	(5) Pulse voltage (B)		Positional Measurement (Rated voltage) V_{P-P} 0			
Voltage	(1) DC voltage	(2) DC+AC voltage	(3) AC voltage															
Positional Measurement (Rated voltage) V_{0-P} 0																		
Voltage	(4) Pulse voltage (A)	(5) Pulse voltage (B)																
Positional Measurement (Rated voltage) V_{P-P} 0																		

No.	Process	Condition																																																				
2	Circuit design ⚠ Caution	<p>2) Even below the rated voltage, if repetitive high frequency AC or pulse is applied, the reliability of the capacitors may be reduced.</p> <p>3) The effective capacitance will vary depending on applied DC and AC voltages. The capacitors should be selected and designed in taking the voltages into consideration.</p> <p>2-3. Frequency When the capacitors (Class 2) are used in AC and/or pulse voltages, the capacitors may vibrate themselves and generate audible sound.</p>																																																				
3	Designing P.C.board	<p>The amount of solder at the terminations has a direct effect on the reliability of the capacitors.</p> <p>1) The greater the amount of solder, the higher the stress on the chip capacitors, and the more likely that it will break. When designing a P.C.board, determine the shape and size of the solder lands to have proper amount of solder on the terminations.</p> <p>2) Avoid using common solder land for multiple terminations and provide individual solder land for each terminations.</p> <p>3) Size and recommended land dimensions.</p> <div style="text-align: center;"> </div> <p style="text-align: center;">Flow soldering (mm)</p> <table border="1" style="width: 100%; border-collapse: collapse; text-align: center;"> <thead> <tr> <th>Type</th> <th>C1608 (CC0603)</th> <th>C2012 (CC0805)</th> <th>C3216 (CC1206)</th> </tr> </thead> <tbody> <tr> <td>A</td> <td>0.7 - 1.0</td> <td>1.0 - 1.3</td> <td>2.1 - 2.5</td> </tr> <tr> <td>B</td> <td>0.8 - 1.0</td> <td>1.0 - 1.2</td> <td>1.1 - 1.3</td> </tr> <tr> <td>C</td> <td>0.6 - 0.8</td> <td>0.8 - 1.1</td> <td>1.0 - 1.3</td> </tr> </tbody> </table> <p style="text-align: center;">Reflow soldering (mm)</p> <table border="1" style="width: 100%; border-collapse: collapse; text-align: center;"> <thead> <tr> <th>Type</th> <th>C1005 (CC0402)</th> <th>C1608 (CC0603)</th> <th>C2012 (CC0805)</th> </tr> </thead> <tbody> <tr> <td>A</td> <td>0.3 - 0.5</td> <td>0.6 - 0.8</td> <td>0.9 - 1.2</td> </tr> <tr> <td>B</td> <td>0.35 - 0.45</td> <td>0.6 - 0.8</td> <td>0.7 - 0.9</td> </tr> <tr> <td>C</td> <td>0.4 - 0.6</td> <td>0.6 - 0.8</td> <td>0.9 - 1.2</td> </tr> </tbody> </table> <table border="1" style="width: 100%; border-collapse: collapse; text-align: center;"> <thead> <tr> <th>Type</th> <th>C3216 (CC1206)</th> <th>C3225 (CC1210)</th> <th>C4532 (CC1812)</th> <th>C5750 (CC2220)</th> </tr> </thead> <tbody> <tr> <td>A</td> <td>2.0 - 2.4</td> <td>2.0 - 2.4</td> <td>3.1 - 3.7</td> <td>4.1 - 4.8</td> </tr> <tr> <td>B</td> <td>1.0 - 1.2</td> <td>1.0 - 1.2</td> <td>1.2 - 1.4</td> <td>1.2 - 1.4</td> </tr> <tr> <td>C</td> <td>1.1 - 1.6</td> <td>1.9 - 2.5</td> <td>2.4 - 3.2</td> <td>4.0 - 5.0</td> </tr> </tbody> </table>	Type	C1608 (CC0603)	C2012 (CC0805)	C3216 (CC1206)	A	0.7 - 1.0	1.0 - 1.3	2.1 - 2.5	B	0.8 - 1.0	1.0 - 1.2	1.1 - 1.3	C	0.6 - 0.8	0.8 - 1.1	1.0 - 1.3	Type	C1005 (CC0402)	C1608 (CC0603)	C2012 (CC0805)	A	0.3 - 0.5	0.6 - 0.8	0.9 - 1.2	B	0.35 - 0.45	0.6 - 0.8	0.7 - 0.9	C	0.4 - 0.6	0.6 - 0.8	0.9 - 1.2	Type	C3216 (CC1206)	C3225 (CC1210)	C4532 (CC1812)	C5750 (CC2220)	A	2.0 - 2.4	2.0 - 2.4	3.1 - 3.7	4.1 - 4.8	B	1.0 - 1.2	1.0 - 1.2	1.2 - 1.4	1.2 - 1.4	C	1.1 - 1.6	1.9 - 2.5	2.4 - 3.2	4.0 - 5.0
Type	C1608 (CC0603)	C2012 (CC0805)	C3216 (CC1206)																																																			
A	0.7 - 1.0	1.0 - 1.3	2.1 - 2.5																																																			
B	0.8 - 1.0	1.0 - 1.2	1.1 - 1.3																																																			
C	0.6 - 0.8	0.8 - 1.1	1.0 - 1.3																																																			
Type	C1005 (CC0402)	C1608 (CC0603)	C2012 (CC0805)																																																			
A	0.3 - 0.5	0.6 - 0.8	0.9 - 1.2																																																			
B	0.35 - 0.45	0.6 - 0.8	0.7 - 0.9																																																			
C	0.4 - 0.6	0.6 - 0.8	0.9 - 1.2																																																			
Type	C3216 (CC1206)	C3225 (CC1210)	C4532 (CC1812)	C5750 (CC2220)																																																		
A	2.0 - 2.4	2.0 - 2.4	3.1 - 3.7	4.1 - 4.8																																																		
B	1.0 - 1.2	1.0 - 1.2	1.2 - 1.4	1.2 - 1.4																																																		
C	1.1 - 1.6	1.9 - 2.5	2.4 - 3.2	4.0 - 5.0																																																		

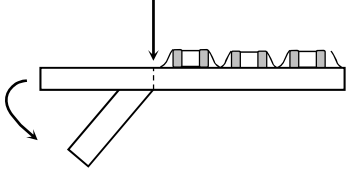
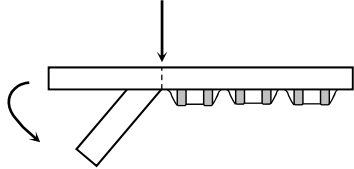
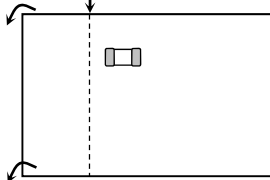
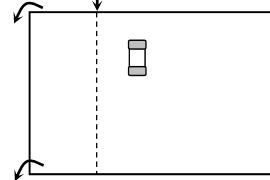
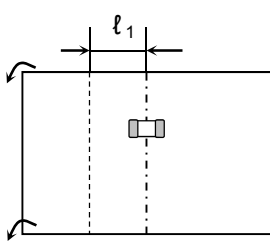
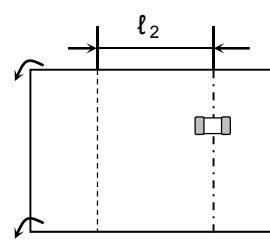
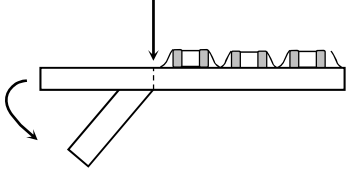
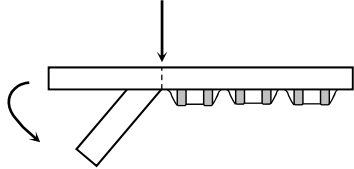
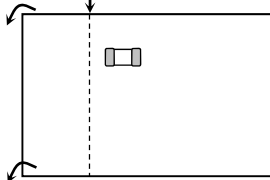
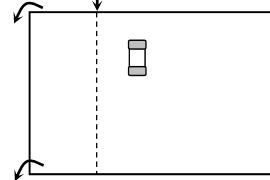
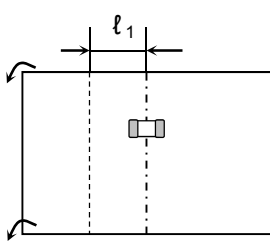
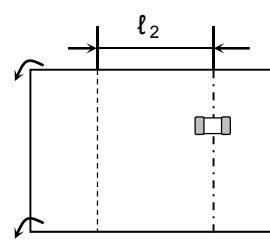
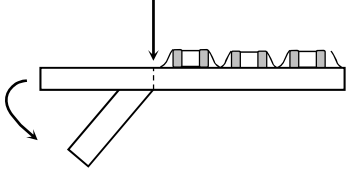
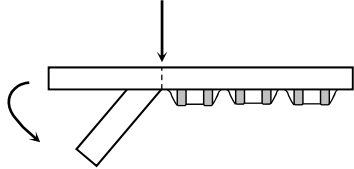
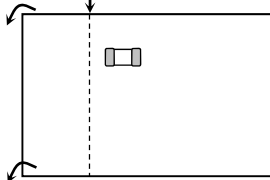
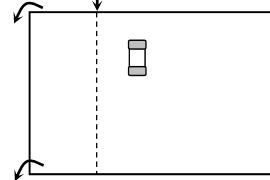
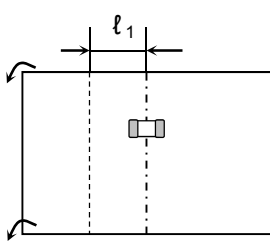
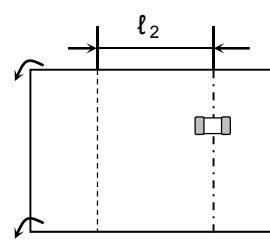
No.	Process	Condition												
3	Designing P.C. board	<p>4) Recommended chip capacitors layout is as following.</p> <table border="1" data-bbox="475 255 1430 1675"> <thead> <tr> <th data-bbox="475 255 660 331"></th> <th data-bbox="660 255 1043 331">Disadvantage against bending stress</th> <th data-bbox="1043 255 1430 331">Advantage against bending stress</th> </tr> </thead> <tbody> <tr> <td data-bbox="475 331 660 748">Mounting face</td> <td data-bbox="660 331 1043 748"> <p>Perforation or slit</p>  <p>Break P.C. board with mounted side up.</p> </td> <td data-bbox="1043 331 1430 748"> <p>Perforation or slit</p>  <p>Break P.C. board with mounted side down.</p> </td> </tr> <tr> <td data-bbox="475 748 660 1196">Chip arrangement (Direction)</td> <td data-bbox="660 748 1043 1196"> <p>Perforation or slit</p>  </td> <td data-bbox="1043 748 1430 1196"> <p>Perforation or slit</p>  </td> </tr> <tr> <td data-bbox="475 1196 660 1675">Distance from slit</td> <td data-bbox="660 1196 1043 1675"> <p>Closer to slit is higher stress</p>  <p>($l_1 < l_2$)</p> </td> <td data-bbox="1043 1196 1430 1675"> <p>Away from slit is less stress</p>  <p>($l_1 < l_2$)</p> </td> </tr> </tbody> </table>		Disadvantage against bending stress	Advantage against bending stress	Mounting face	<p>Perforation or slit</p>  <p>Break P.C. board with mounted side up.</p>	<p>Perforation or slit</p>  <p>Break P.C. board with mounted side down.</p>	Chip arrangement (Direction)	<p>Perforation or slit</p> 	<p>Perforation or slit</p> 	Distance from slit	<p>Closer to slit is higher stress</p>  <p>($l_1 < l_2$)</p>	<p>Away from slit is less stress</p>  <p>($l_1 < l_2$)</p>
	Disadvantage against bending stress	Advantage against bending stress												
Mounting face	<p>Perforation or slit</p>  <p>Break P.C. board with mounted side up.</p>	<p>Perforation or slit</p>  <p>Break P.C. board with mounted side down.</p>												
Chip arrangement (Direction)	<p>Perforation or slit</p> 	<p>Perforation or slit</p> 												
Distance from slit	<p>Closer to slit is higher stress</p>  <p>($l_1 < l_2$)</p>	<p>Away from slit is less stress</p>  <p>($l_1 < l_2$)</p>												

No.	Process	Condition												
3	Designing P.C. board	<p>5) Mechanical stress varies according to location of chip capacitors on the P.C. board.</p> <div data-bbox="491 271 1299 826" data-label="Diagram"> </div> <p>The stress in capacitors is in the following order. $A > B = C > D > E$</p> <p>6) Layout recommendation</p> <table border="1" data-bbox="379 1010 1481 1921"> <thead> <tr> <th data-bbox="379 1010 539 1122">Example</th> <th data-bbox="539 1010 842 1122">Use of common solder land</th> <th data-bbox="842 1010 1150 1122">Soldering with chassis</th> <th data-bbox="1150 1010 1481 1122">Use of common solder land with other SMD</th> </tr> </thead> <tbody> <tr> <td data-bbox="379 1122 539 1507">Need to avoid</td> <td data-bbox="539 1122 842 1507"> </td> <td data-bbox="842 1122 1150 1507"> </td> <td data-bbox="1150 1122 1481 1507"> </td> </tr> <tr> <td data-bbox="379 1507 539 1921">Recommendation</td> <td data-bbox="539 1507 842 1921"> </td> <td data-bbox="842 1507 1150 1921"> </td> <td data-bbox="1150 1507 1481 1921"> </td> </tr> </tbody> </table>	Example	Use of common solder land	Soldering with chassis	Use of common solder land with other SMD	Need to avoid				Recommendation			
Example	Use of common solder land	Soldering with chassis	Use of common solder land with other SMD											
Need to avoid														
Recommendation														

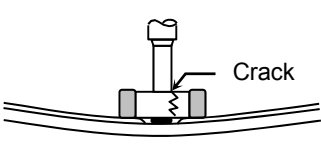
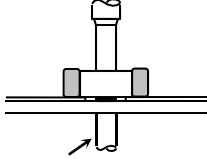
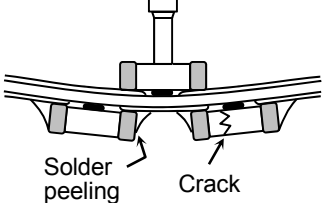
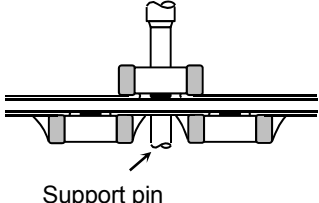
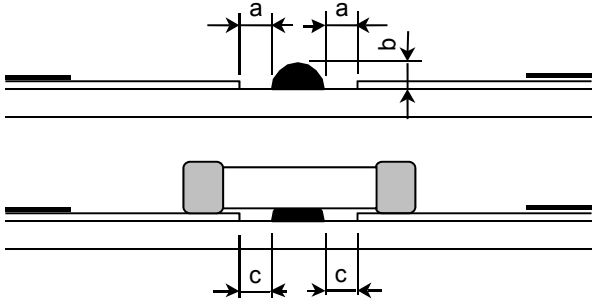
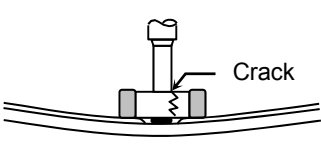
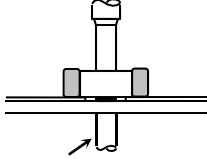
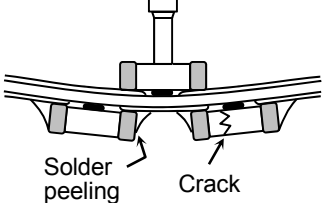
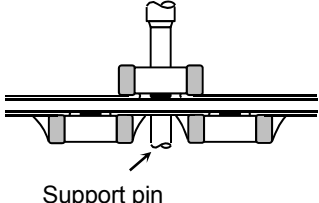
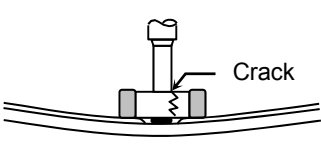
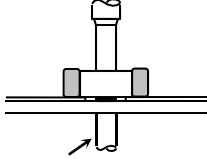
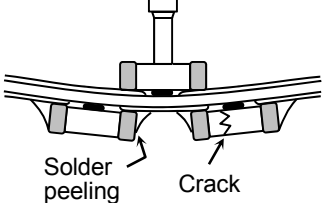
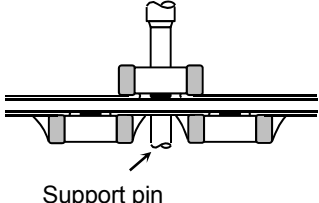
No.	Process	Condition															
4	Mounting	<p>4-1. Stress from mounting head If the mounting head is adjusted too low, it may induce excessive stress in the chip capacitors to result in cracking. Please take following precautions.</p> <ol style="list-style-type: none"> 1) Adjust the bottom dead center of the mounting head to reach on the P.C. board surface and not press it. 2) Adjust the mounting head pressure to be 1 to 3N of static weight. 3) To minimize the impact energy from mounting head, it is important to provide support from the bottom side of the P.C. board. See following examples. <table border="1" data-bbox="481 600 1433 1160"> <thead> <tr> <th></th> <th>Not recommended</th> <th>Recommended</th> </tr> </thead> <tbody> <tr> <td>Single sided mounting</td> <td></td> <td></td> </tr> <tr> <td>Double-sides mounting</td> <td></td> <td></td> </tr> </tbody> </table> <p>When the centering jaw is worn out, it may give mechanical impact on the capacitors to cause crack. Please control the close up dimension of the centering jaw and provide sufficient preventive maintenance and replacement of it.</p> <p>4-2. Amount of adhesive</p>  <p>Example : C2012 (CC0805), C3216 (CC1206)</p> <table border="1" data-bbox="662 1780 1216 1944"> <tbody> <tr> <td>a</td> <td>0.2mm min.</td> </tr> <tr> <td>b</td> <td>70 - 100μm</td> </tr> <tr> <td>c</td> <td>Do not touch the solder land</td> </tr> </tbody> </table>		Not recommended	Recommended	Single sided mounting			Double-sides mounting			a	0.2mm min.	b	70 - 100μm	c	Do not touch the solder land
	Not recommended	Recommended															
Single sided mounting																	
Double-sides mounting																	
a	0.2mm min.																
b	70 - 100μm																
c	Do not touch the solder land																

No.	Process	Condition																			
5	Soldering	<p>5-1. Flux selection</p> <p>Although highly-activated flux gives better solderability, substances which increase activity may also degrade the insulation of the chip capacitors. To avoid such degradation, it is recommended following.</p> <ol style="list-style-type: none"> 1) It is recommended to use a mildly activated rosin flux (less than 0.1wt% chlorine). Strong flux is not recommended. 2) Excessive flux must be avoided. Please provide proper amount of flux. 3) When water-soluble flux is used, enough washing is necessary. <p>5-2. Recommended soldering profile by various methods</p> <div style="display: flex; justify-content: space-around;"> <div style="text-align: center;"> <p>Wave soldering</p> </div> <div style="text-align: center;"> <p>Reflow soldering</p> </div> </div> <div style="text-align: center; margin-top: 20px;"> <p>Manual soldering (Solder iron)</p> </div> <div style="margin-top: 20px;"> <p><u>APPLICATION</u></p> <p>As for C1608 (CC0603), C2012 (CC0805) and C3216 (CC1206), applied to wave soldering and reflow soldering.</p> <p>As for C1005 (CC0402), C3225 (CC1210), C4532 (CC1812) and C5750 (CC2220), applied only to reflow soldering.</p> </div> <p>※ As for peak temperature of manual soldering, please refer “5-6. Solder repair by solder iron” .</p> <p>5-3. Recommended soldering peak temp and peak temp duration</p> <table border="1" style="width: 100%; border-collapse: collapse; text-align: center;"> <thead> <tr> <th rowspan="2" style="text-align: left;">Temp./Duration</th> <th colspan="2">Wave soldering</th> <th colspan="2">Reflow soldering</th> </tr> <tr> <th>Peak temp(°C)</th> <th>Duration(sec.)</th> <th>Peak temp(°C)</th> <th>Duration(sec.)</th> </tr> </thead> <tbody> <tr> <td style="text-align: left;">Sn-Pb Solder</td> <td>250 max.</td> <td>3 max.</td> <td>230 max.</td> <td>20 max.</td> </tr> <tr> <td style="text-align: left;">Lead Free Solder</td> <td>260 max.</td> <td>5 max.</td> <td>260 max.</td> <td>10 max.</td> </tr> </tbody> </table> <p>Recommended solder compositions</p> <p>Sn-37Pb (Sn-Pb solder)</p> <p>Sn-3.0Ag-0.5Cu (Lead Free Solder)</p>	Temp./Duration	Wave soldering		Reflow soldering		Peak temp(°C)	Duration(sec.)	Peak temp(°C)	Duration(sec.)	Sn-Pb Solder	250 max.	3 max.	230 max.	20 max.	Lead Free Solder	260 max.	5 max.	260 max.	10 max.
Temp./Duration	Wave soldering			Reflow soldering																	
	Peak temp(°C)	Duration(sec.)	Peak temp(°C)	Duration(sec.)																	
Sn-Pb Solder	250 max.	3 max.	230 max.	20 max.																	
Lead Free Solder	260 max.	5 max.	260 max.	10 max.																	

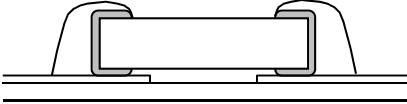
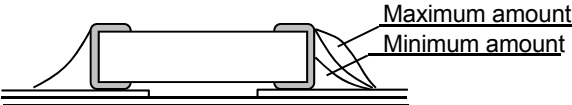
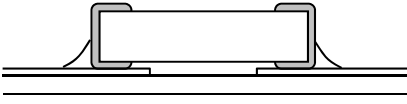
No.	Process	Condition																												
5	Soldering	<p>5-4. Avoiding thermal shock</p> <p>1) Preheating condition</p> <table border="1" data-bbox="552 255 1426 622"> <thead> <tr> <th>Soldering</th> <th>Type</th> <th>Temp. (°C)</th> </tr> </thead> <tbody> <tr> <td>Wave soldering</td> <td>C1608(CC0603), C2012(CC0805), C3216(CC1206)</td> <td>$\Delta T \leq 150$</td> </tr> <tr> <td rowspan="2">Reflow soldering</td> <td>C1005(CC0402), C1608(CC0603), C2012(CC0805), C3216(CC1206)</td> <td>$\Delta T \leq 150$</td> </tr> <tr> <td>C3225(CC1210), C4532(CC1812), C5750(CC2220)</td> <td>$\Delta T \leq 130$</td> </tr> <tr> <td rowspan="2">Manual soldering</td> <td>C1005(CC0402), C1608(CC0603), C2012(CC0805), C3216(CC1206)</td> <td>$\Delta T \leq 150$</td> </tr> <tr> <td>C3225(CC1210), C4532(CC1812), C5750(CC2220)</td> <td>$\Delta T \leq 130$</td> </tr> </tbody> </table> <p>2) Cooling condition Natural cooling using air is recommended. If the chips are dipped into a solvent for cleaning, the temperature difference (ΔT) must be less than 100°C.</p> <p>5-5. Amount of solder Excessive solder will induce higher tensile force in chip capacitors when temperature changes and it may result in chip cracking. In sufficient solder may detach the capacitors from the P.C. board.</p> <div style="display: flex; justify-content: space-between; align-items: flex-start;"> <div style="width: 30%;">Excessive solder</div> <div style="width: 30%; text-align: center;">  </div> <div style="width: 30%;">Higher tensile force in chip capacitors to cause crack</div> </div> <hr/> <div style="display: flex; justify-content: space-between; align-items: center;"> <div style="width: 30%;">Adequate</div> <div style="width: 30%; text-align: center;">  </div> </div> <hr/> <div style="display: flex; justify-content: space-between; align-items: flex-start;"> <div style="width: 30%;">Insufficient solder</div> <div style="width: 30%; text-align: center;">  </div> <div style="width: 30%;">Low robustness may cause contact failure or chip capacitors come off the P.C. board.</div> </div> <p>5-6. Solder repair by solder iron</p> <p>1) Selection of the soldering iron tip Tip temperature of solder iron varies by its type, P.C. board material and solder land size. The higher the tip temperature, the quicker the operation. However, heat shock may cause a crack in the chip capacitors. Please make sure the tip temp. before soldering and keep the peak temp and time in accordance with following recommended condition. (Please preheat the chip capacitors with the condition in 5-4 to avoid the thermal shock.)</p> <p style="text-align: center;">Recommended solder iron condition (Sn-Pb Solder and Lead Free Solder)</p> <table border="1" data-bbox="496 1738 1445 2022"> <thead> <tr> <th>Type</th> <th>Temp. (°C)</th> <th>Duration (sec.)</th> <th>Wattage (W)</th> <th>Shape (mm)</th> </tr> </thead> <tbody> <tr> <td>C1005(CC0402) C1608(CC0603) C2012(CC0805) C3216(CC1206)</td> <td>350 max.</td> <td rowspan="2">3 max.</td> <td rowspan="2">20 max.</td> <td rowspan="2">Ø 3.0 max.</td> </tr> <tr> <td>C3225(CC1210) C4532(CC1812) C5750(CC2220)</td> <td>280 max.</td> </tr> </tbody> </table>	Soldering	Type	Temp. (°C)	Wave soldering	C1608(CC0603), C2012(CC0805), C3216(CC1206)	$\Delta T \leq 150$	Reflow soldering	C1005(CC0402), C1608(CC0603), C2012(CC0805), C3216(CC1206)	$\Delta T \leq 150$	C3225(CC1210), C4532(CC1812), C5750(CC2220)	$\Delta T \leq 130$	Manual soldering	C1005(CC0402), C1608(CC0603), C2012(CC0805), C3216(CC1206)	$\Delta T \leq 150$	C3225(CC1210), C4532(CC1812), C5750(CC2220)	$\Delta T \leq 130$	Type	Temp. (°C)	Duration (sec.)	Wattage (W)	Shape (mm)	C1005(CC0402) C1608(CC0603) C2012(CC0805) C3216(CC1206)	350 max.	3 max.	20 max.	Ø 3.0 max.	C3225(CC1210) C4532(CC1812) C5750(CC2220)	280 max.
Soldering	Type	Temp. (°C)																												
Wave soldering	C1608(CC0603), C2012(CC0805), C3216(CC1206)	$\Delta T \leq 150$																												
Reflow soldering	C1005(CC0402), C1608(CC0603), C2012(CC0805), C3216(CC1206)	$\Delta T \leq 150$																												
	C3225(CC1210), C4532(CC1812), C5750(CC2220)	$\Delta T \leq 130$																												
Manual soldering	C1005(CC0402), C1608(CC0603), C2012(CC0805), C3216(CC1206)	$\Delta T \leq 150$																												
	C3225(CC1210), C4532(CC1812), C5750(CC2220)	$\Delta T \leq 130$																												
Type	Temp. (°C)	Duration (sec.)	Wattage (W)	Shape (mm)																										
C1005(CC0402) C1608(CC0603) C2012(CC0805) C3216(CC1206)	350 max.	3 max.	20 max.	Ø 3.0 max.																										
C3225(CC1210) C4532(CC1812) C5750(CC2220)	280 max.																													

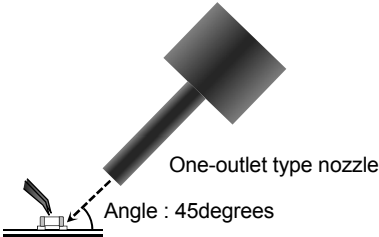
No.	Process	Condition												
5	Soldering	<p>2) Direct contact of the soldering iron with ceramic dielectric of chip capacitors may cause crack. Do not touch the ceramic dielectric and the terminations by solder iron.</p> <p>5-7.Soldering rework using spot heater Heat stress during rework may possibly be reduced by using a spot heater (also called a “blower”) rather than a soldering iron. It is applied only to adding solder in the case of insufficient solder amount.</p> <p>1) Reworking using a spot heater may suppress the occurrence of cracks in the capacitor compared to using a soldering iron. A spot heater can heat up a capacitor uniformly with a small heat gradient which leads to lower thermal stress caused by quick heating and cooling or localized heating. Moreover, where ultra-small capacitors are mounted close together on a printed circuit board, reworking with a spot heater can eliminate the risk of direct contact between the tip of a soldering iron and a capacitor.</p> <p>2) Rework condition If the blower nozzle of a spot heater is too close to a capacitor, a crack in the capacitor may occur due to heat stress. Below are recommendations for avoiding such an occurrence. Keep more than 5mm between a capacitor and a spot heater nozzle. The blower temperature of the spot heater shall be lower than 400°C. The airflow shall be set as weak as possible. The diameter of the nozzle is recommended to be 2mm(one-outlet type).The size is standard and common. Duration of blowing hot air is recommended to be 10s or less for C1608 (CC0603), C2012 (CC0805) and C3216 (CC1206), and 30s or less for C3225 (CC1210), C4532 (CC1812) and C5750 (CC2220), considering surface area of the capacitor and melting temperature of solder. The angle between the nozzle and the capacitor is recommended to be 45degrees in order to work easily and to avoid partial area heating. As is the case when using a soldering iron, preheating reduces thermal stress on capacitors and improves operating efficiency.</p> <p>• Recommended rework condition (Consult the component manufactures for details.)</p> <table border="1" data-bbox="523 1294 1465 1641"> <tbody> <tr> <td>Distance from nozzle</td> <td>5mm and over</td> </tr> <tr> <td>Nozzle angle</td> <td>45degrees</td> </tr> <tr> <td>Nozzle temp.</td> <td>400°C and less</td> </tr> <tr> <td>Airflow</td> <td>Set as weak as possible (The airflow shall be the minimum value necessary for solder to melt in the conditions mentioned above.)</td> </tr> <tr> <td>Nozzle diameter</td> <td>φ 2mm (one-outlet type)</td> </tr> <tr> <td>Blowing duration</td> <td>10s and less (C1608[CC0603], C2012[CC0805], C3216[CC1206]) 30s and less (C3225[CC1210], C4532[CC1812], C5750[CC2220])</td> </tr> </tbody> </table> <p>• Example of recommended spot heater use</p> 	Distance from nozzle	5mm and over	Nozzle angle	45degrees	Nozzle temp.	400°C and less	Airflow	Set as weak as possible (The airflow shall be the minimum value necessary for solder to melt in the conditions mentioned above.)	Nozzle diameter	φ 2mm (one-outlet type)	Blowing duration	10s and less (C1608[CC0603], C2012[CC0805], C3216[CC1206]) 30s and less (C3225[CC1210], C4532[CC1812], C5750[CC2220])
Distance from nozzle	5mm and over													
Nozzle angle	45degrees													
Nozzle temp.	400°C and less													
Airflow	Set as weak as possible (The airflow shall be the minimum value necessary for solder to melt in the conditions mentioned above.)													
Nozzle diameter	φ 2mm (one-outlet type)													
Blowing duration	10s and less (C1608[CC0603], C2012[CC0805], C3216[CC1206]) 30s and less (C3225[CC1210], C4532[CC1812], C5750[CC2220])													

No.	Process	Condition
5	Soldering	<p>3) Amount of solder should be suitable to form a proper fillet shape. Excess solder causes mechanical and thermal stress on a capacitor and results in cracks. Insufficient solder causes weak adherence of the capacitor to the substrate and may result in detachment of a capacitor and deteriorate reliability of the printed wiring board. See the example of appropriate solder fillet shape for 5-5.Amount of solder.</p> <p>5-8. Sn-Zn solder Sn-Zn solder affects product reliability. Please contact TDK in advance when utilize Sn-Zn solder.</p> <p>5-9. Countermeasure for tombstone The misalignment between the mounted positions of the capacitors and the land patterns should be minimized. The tombstone phenomenon may occur especially the capacitors are mounted (in longitudinal direction) in the same direction of the reflow soldering. (Refer to JEITA RCR-2335C Annex A (Informative) Recommendations to prevent the tombstone phenomenon)</p>
6	Cleaning	<p>1) If an unsuitable cleaning fluid is used, flux residue or some foreign articles may stick to chip capacitors surface to deteriorate especially the insulation resistance.</p> <p>2) If cleaning condition is not suitable, it may damage the chip capacitors.</p> <p>2)-1. Insufficient washing (1) Terminal electrodes may corrode by Halogen in the flux. (2) Halogen in the flux may adhere on the surface of capacitors, and lower the insulation resistance. (3) Water soluble flux has higher tendency to have above mentioned problems (1) and (2).</p> <p>2)-2. Excessive washing When ultrasonic cleaning is used, excessively high ultrasonic energy output can affect the connection between the ceramic chip capacitor's body and the terminal electrode. To avoid this, following is the recommended condition. Power : 20 W/ℓ max. Frequency : 40 kHz max. Washing time : 5 minutes max.</p> <p>2)-3. If the cleaning fluid is contaminated, density of Halogen increases, and it may bring the same result as insufficient cleaning.</p>

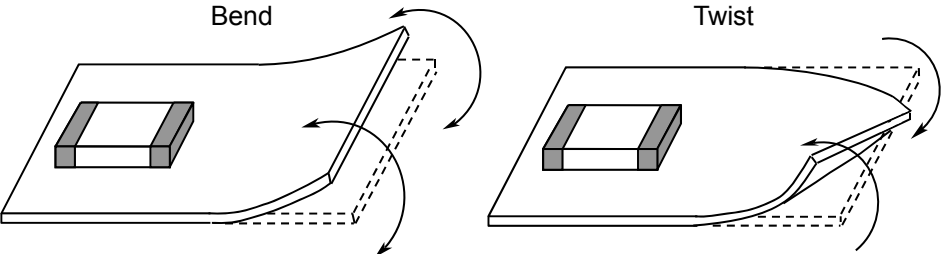
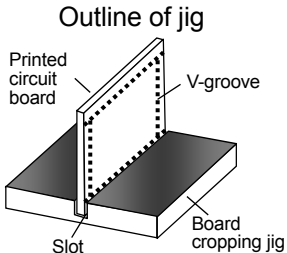
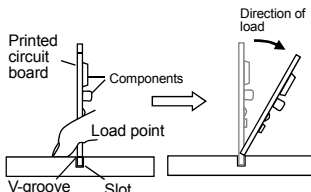
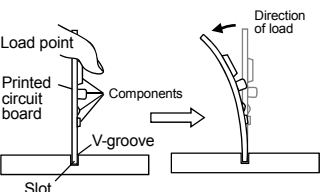
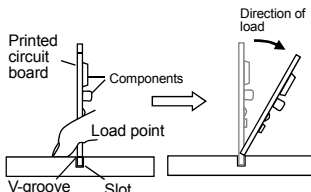
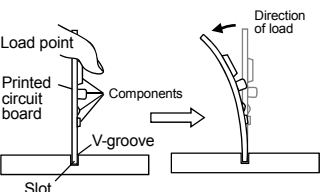
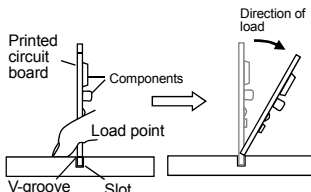
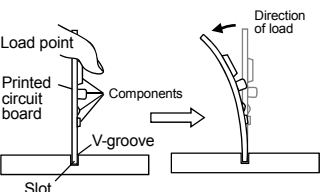
No.	Process	Condition				
7	Coating and molding of the P.C. board	1) When the P.C. board is coated, please verify the quality influence on the product. 2) Please verify carefully that there is no harmful decomposing or reaction gas emission during curing which may damage the chip capacitors. 3) Please verify the curing temperature.				
8	Handling after chip mounted ⚠ Caution	1) Please pay attention not to bend or distort the P.C. board after soldering in handling otherwise the chip capacitors may crack.  2) Printed circuit board cropping should not be carried out by hand, but by using the proper tooling. Printed circuit board cropping should be carried out using a board cropping jig as shown in the following figure or a board cropping apparatus to prevent inducing mechanical stress on the board. (1) Example of a board cropping jig Recommended example: The board should be pushed from the back side, close to the cropping jig so that the board is not bent and the stress applied to the capacitor is compressive. Unrecommended example: If the pushing point is far from the cropping jig and the pushing direction is from the front side of the board, large tensile stress is applied to the capacitor, which may cause cracks.  <table border="1" data-bbox="778 1187 1460 1444"> <thead> <tr> <th data-bbox="778 1187 1114 1238">Recommended</th> <th data-bbox="1114 1187 1460 1238">Unrecommended</th> </tr> </thead> <tbody> <tr> <td data-bbox="778 1238 1114 1444">  </td> <td data-bbox="1114 1238 1460 1444">  </td> </tr> </tbody> </table>	Recommended	Unrecommended		
Recommended	Unrecommended					
						

No.	Process	Condition																		
8	Handling after chip mounted ⚠ Caution	<p>(2) Example of a board cropping machine</p> <p>An outline of a printed circuit board cropping machine is shown below. The top and bottom blades are aligned with one another along the lines with the V-grooves on printed circuit board when cropping the board.</p> <p>Unrecommended example: Misalignment of blade position between top and bottom, right and left, or front and rear blades may cause a crack in the capacitor.</p> <div style="display: flex; justify-content: space-around;"> <div data-bbox="571 488 981 743"> <p>Outline of machine</p> </div> <div data-bbox="981 488 1423 728"> <p>Principle of operation</p> </div> </div> <div style="text-align: center; margin-top: 10px;"> <p>Cross-section diagram</p> </div> <table border="1" style="width: 100%; text-align: center; margin-top: 20px;"> <thead> <tr> <th data-bbox="655 965 836 1012">Recommended</th> <th colspan="3" data-bbox="836 965 1366 1012">Unrecommended</th> </tr> <tr> <th></th> <th data-bbox="836 1012 1016 1093">Top-bottom misalignment</th> <th data-bbox="1016 1012 1181 1093">Left-right misalignment</th> <th data-bbox="1181 1012 1366 1093">Front-rear misalignment</th> </tr> </thead> <tbody> <tr> <td data-bbox="655 1093 836 1391"> </td> <td data-bbox="836 1093 1016 1391"> </td> <td data-bbox="1016 1093 1181 1391"> </td> <td data-bbox="1181 1093 1366 1391"> </td> </tr> </tbody> </table> <p>3) When functional check of the P.C. board is performed, check pin pressure tends to be adjusted higher for fear of loose contact. But if the pressure is excessive and bend the P.C. board, it may crack the chip capacitors or peel the terminations off. Please adjust the check pins not to bend the P.C. board.</p> <table border="1" style="width: 100%; text-align: center; margin-top: 20px;"> <thead> <tr> <th data-bbox="491 1637 630 1697">Item</th> <th data-bbox="630 1637 1046 1697">Not recommended</th> <th data-bbox="1046 1637 1445 1697">Recommended</th> </tr> </thead> <tbody> <tr> <td data-bbox="491 1697 630 1935">Board bending</td> <td data-bbox="630 1697 1046 1935"> </td> <td data-bbox="1046 1697 1445 1935"> </td> </tr> </tbody> </table>	Recommended	Unrecommended				Top-bottom misalignment	Left-right misalignment	Front-rear misalignment					Item	Not recommended	Recommended	Board bending		
Recommended	Unrecommended																			
	Top-bottom misalignment	Left-right misalignment	Front-rear misalignment																	
Item	Not recommended	Recommended																		
Board bending																				

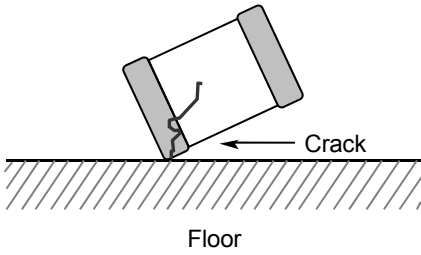
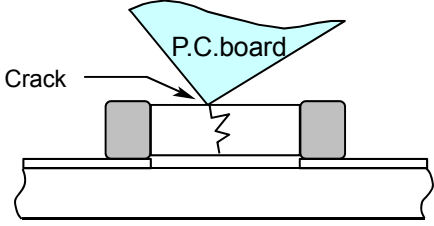
No.	Process	Condition
9	Handling of loose chip capacitors	<p>1) If dropped the chip capacitors may crack. Once dropped do not use it. Especially, the large case sized chip capacitors are tendency to have cracks easily, so please handle with care.</p>  <p>2) Piling the P.C.board after mounting for storage or handling, the corner of the P.C. board may hit the chip capacitors of another board to cause crack.</p> 
10	Capacitance aging	The capacitors (Class 2) have aging in the capacitance. They may not be used in precision time constant circuit. In case of the time constant circuit, the evaluation should be done well.
11	Estimated life and estimated failure rate of capacitors	As per the estimated life and the estimated failure rate depend on the temperature and the voltage. This can be calculated by the equation described in JEITA RCR-2335C Annex F (Informative) Calculation of the estimated lifetime and the estimated failure rate (Voltage acceleration coefficient : 3 multiplication rule, Temperature acceleration coefficient : 10°C rule) The failure rate can be decreased by reducing the temperature and the voltage but they will not be guaranteed.

No.	Process	Condition
12	Caution during operation of equipment	<p>1) A capacitor shall not be touched directly with bare hands during operation in order to avoid electric shock. Electric energy held by the capacitor may be discharged through the human body when touched with a bare hand. Even when the equipment is off, a capacitor may stay charged. The capacitor should be handled after being completely discharged using a resistor.</p> <p>2) The terminals of a capacitor shall not be short-circuited by any accidental contact with a conductive object. A capacitor shall not be exposed to a conductive liquid such as an acid or alkali solution. A conductive object or liquid, such as acid and alkali, between the terminals may lead to the breakdown of a capacitor due to short circuit</p> <p>3) Confirm that the environment to which the equipment will be exposed during transportation and operation meets the specified conditions. Do not to use the equipment in the following environments.</p> <p>(1) Environment where a capacitor is splattered with water or oil (2) Environment where a capacitor is exposed to direct sunlight (3) Environment where a capacitor is exposed to Ozone, ultraviolet rays or radiation (4) Environment where a capacitor exposed to corrosive gas(e.g. hydrogen sulfide, sulfur dioxide, chlorine. ammonia gas etc.) (5) Environment where a capacitor exposed to vibration or mechanical shock exceeding the specified limits. (6) Atmosphere change with causes condensation</p>
13	Others  Caution	<p>The products listed on this specification sheet are intended for use in general electronic equipment (AV equipment, telecommunications equipment, home appliances, amusement equipment, computer equipment, personal equipment, office equipment, measurement equipment, industrial robots) under a normal operation and use condition.</p> <p>The products are not designed or warranted to meet the requirements of the applications listed below, whose performance and/or quality require a more stringent level of safety or reliability, or whose failure, malfunction or trouble could cause serious damage to society, person or property. Please understand that we are not responsible for any damage or liability caused by use of the products in any of the applications below or for any other use exceeding the range or conditions set forth in this specification sheet. If you intend to use the products in the applications listed below or if you have special requirements exceeding the range or conditions set forth in this specification, please contact us.</p> <p>(1) Aerospace/Aviation equipment (2) Transportation equipment (cars, electric trains, ships, etc.) (3) Medical equipment (Excepting Pharmaceutical Affairs Law classification Class1, 2) (4) Power-generation control equipment (5) Atomic energy-related equipment (6) Seabed equipment (7) Transportation control equipment (8) Public information-processing equipment (9) Military equipment (10) Electric heating apparatus, burning equipment (11) Disaster prevention/crime prevention equipment (12) Safety equipment (13) Other applications that are not considered general-purpose applications</p> <p>When designing your equipment even for general-purpose applications, you are kindly requested to take into consideration securing protection circuit/device or providing backup circuits in your equipment.</p>

14. TAPE PACKAGING SPECIFICATION

1. CONSTRUCTION AND DIMENSION OF TAPING

1-1. Dimensions of carrier tape

Dimensions of paper tape shall be according to Appendix 3, 4.

Dimensions of plastic tape shall be according to Appendix 5, 6.

1-2. Bulk part and leader of taping

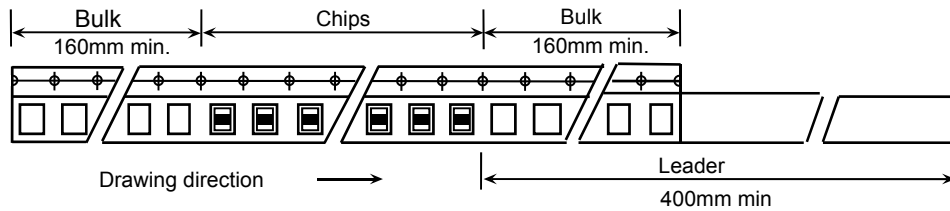

1-3. Dimensions of reel

Dimensions of Ø178 reel shall be according to Appendix 7, 8.

Dimensions of Ø330 reel shall be according to Appendix 9, 10.

1-4. Structure of taping

(a) Paper

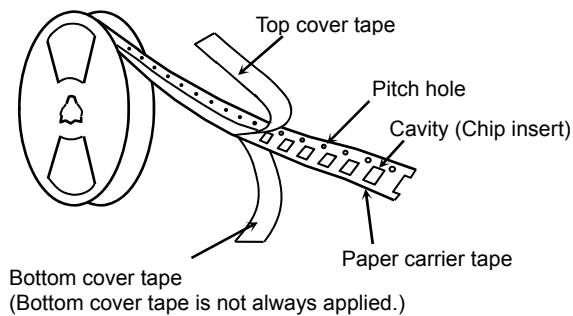

(b) Plastic

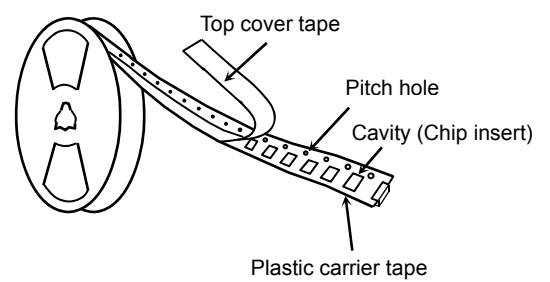

2. CHIP QUANTITY

As for chip quantity and taping material of each product, please refer to detailed information on TDK web.

3. PERFORMANCE SPECIFICATIONS

3-1. Fixing peeling strength (top tape)

0.05-0.7N. (See the following figure.)

〈Paper〉

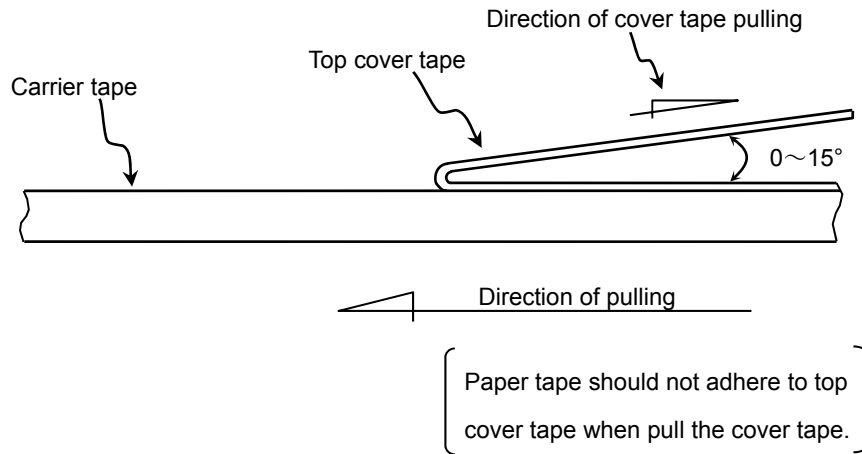

〈Plastic〉

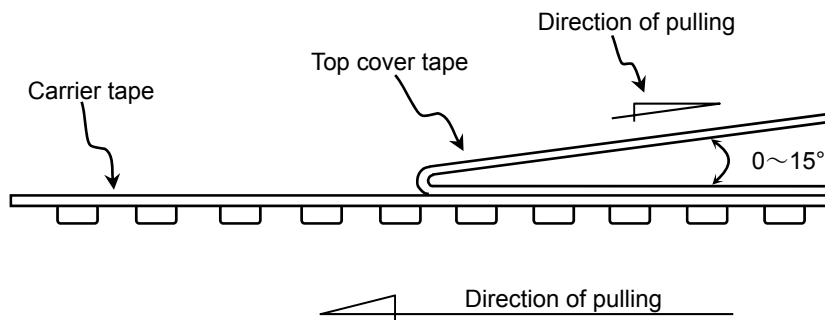

3-2. Carrier tape shall be flexible enough to be wound around a minimum radius of 30mm with components in tape.

3-3. The missing of components shall be less than 0.1%

3-4. Components shall not stick to fixing tape.

3-5. The fixing tapes shall not protrude beyond the edges of the carrier tape not shall cover the sprocket holes.

Appendix 3

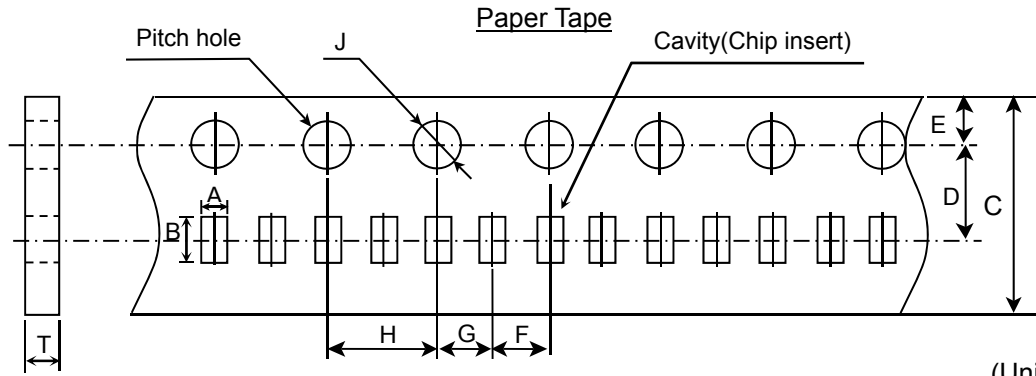

(Unit : mm)

Symbol Type	A	B	C	D	E	F
C1005 (CC0402)	(0.65)	(1.15)	8.00 ± 0.30	3.50 ± 0.05	1.75 ± 0.10	2.00 ± 0.05

Symbol Type	G	H	J	T
C1005 (CC0402)	2.00 ± 0.05	4.00 ± 0.10	$\varnothing 1.5 \begin{matrix} +0.10 \\ 0 \end{matrix}$	0.60 ± 0.05

() Reference value.

Appendix 4

Paper Tape

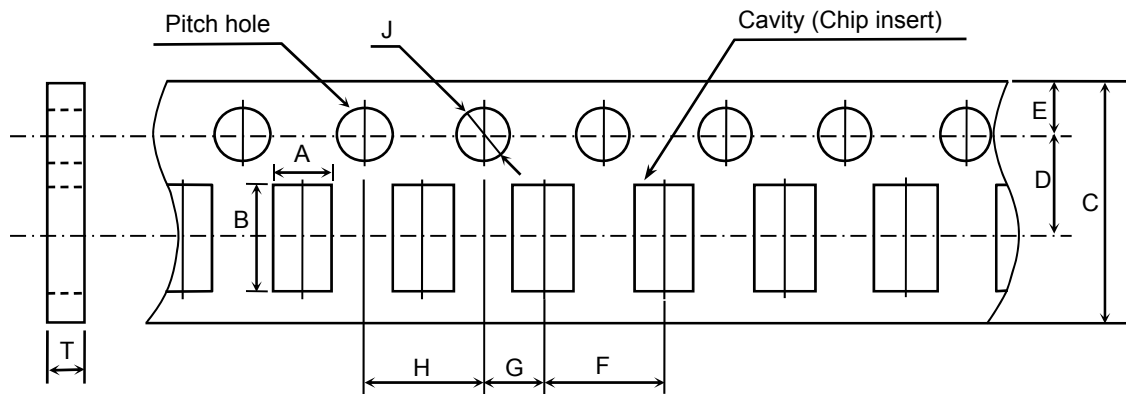

(Unit : mm)

Symbol Type	A	B	C	D	E	F
C1608 (CC0603)	(1.10)	(1.90)	8.00 ± 0.30	3.50 ± 0.05	1.75 ± 0.10	4.00 ± 0.10
C2012 (CC0805)	(1.50)	(2.30)				
C3216 (CC1206)	(1.90)	(3.50)				
Symbol Type	G	H	J	T		
C1608 (CC0603)	2.00 ± 0.05	4.00 ± 0.10	∅ 1.5 ^{+0.10} ₀	1.20 max.		
C2012 (CC0805)						
C3216 (CC1206)						

() Reference value.

Appendix 5

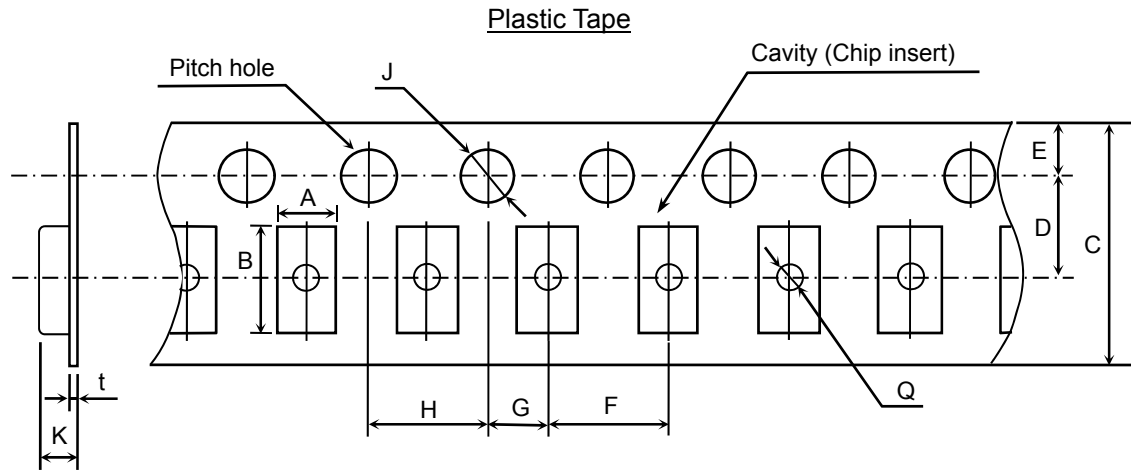

(Unit : mm)

Symbol Type	A	B	C	D	E	F
C2012 (CC0805)	(1.50)	(2.30)	8.00 ± 0.30	3.50 ± 0.05	1.75 ± 0.10	4.00 ± 0.10
C3216 (CC1206)	(1.90)	(3.50)				
C3225 (CC1210)	(2.90)	(3.60)				
Symbol Type	G	H	J	K	t	Q
C2012 (CC0805)	2.00 ± 0.05	4.00 ± 0.10	∅ 1.5 $\begin{matrix} +0.10 \\ 0 \end{matrix}$	3.20 max.	0.60 max.	∅ 0.50 min.
C3216 (CC1206)						
C3225 (CC1210)						

() Reference value.

Exceptionally no hole in the cavity is applied. Please inquire if hole in cavity is mandatory.

* Applied to thickness, 2.5mm products.

Appendix 6

Plastic Tape

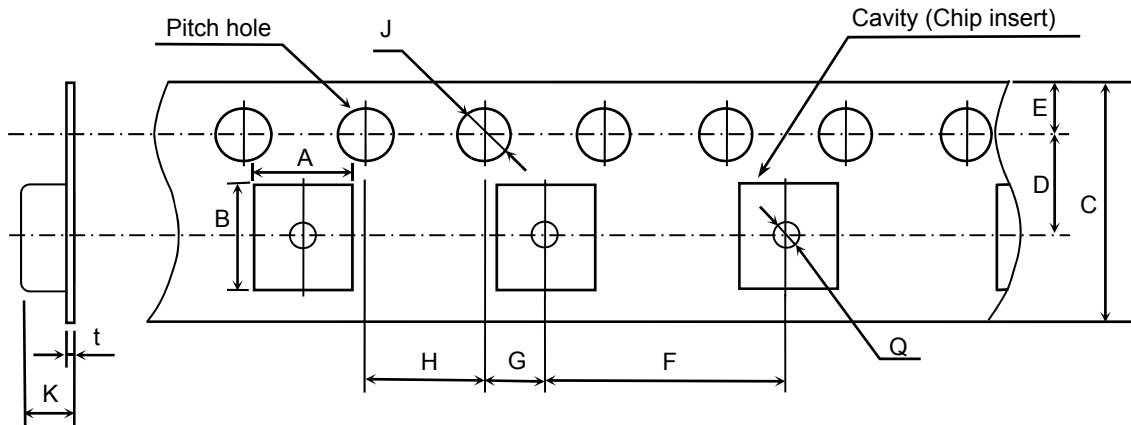

(Unit : mm)

Symbol Type	A	B	C	D	E	F
C4532 (CC1812)	(3.60)	(4.90)	12.0 ± 0.30	5.50 ± 0.05	1.75 ± 0.10	8.00 ± 0.10
C5750 (CC2220)	(5.40)	(6.10)				
Symbol Type	G	H	J	K	t	Q
C4532 (CC1812)	2.00 ± 0.05	4.00 ± 0.10	∅ 1.5 $\begin{matrix} +0.10 \\ 0 \end{matrix}$	6.50 max.	0.60 max.	∅ 1.50 min.
C5750 (CC2220)						

() Reference value.

Appendix 7

C1005, C1608, C2012, C3216, C3225
 (As for C3225 type, any thickness of the item except 2.5mm)
 (Material : Polystyrene)

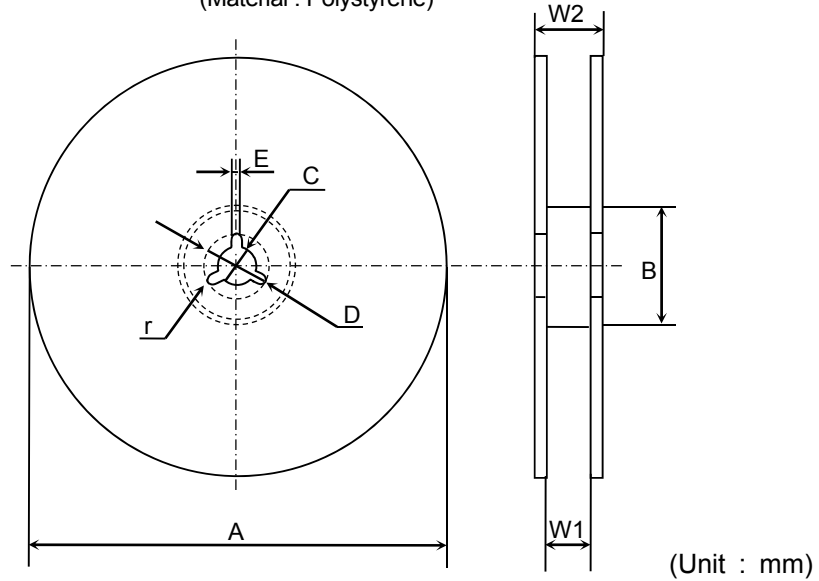

Symbol	A	B	C	D	E	W_1
Dimension	$\varnothing 178 \pm 2.0$	$\varnothing 60 \pm 2.0$	$\varnothing 13 \pm 0.5$	$\varnothing 21 \pm 0.8$	2.0 ± 0.5	9.0 ± 0.3
Symbol	W_2	r				
Dimension	13.0 ± 1.4	1.0				

Appendix 8

C3225, C4532, C5750 (As for C3225 type, applied to 2.5mm thickness products)
 (Material : Polystyrene)

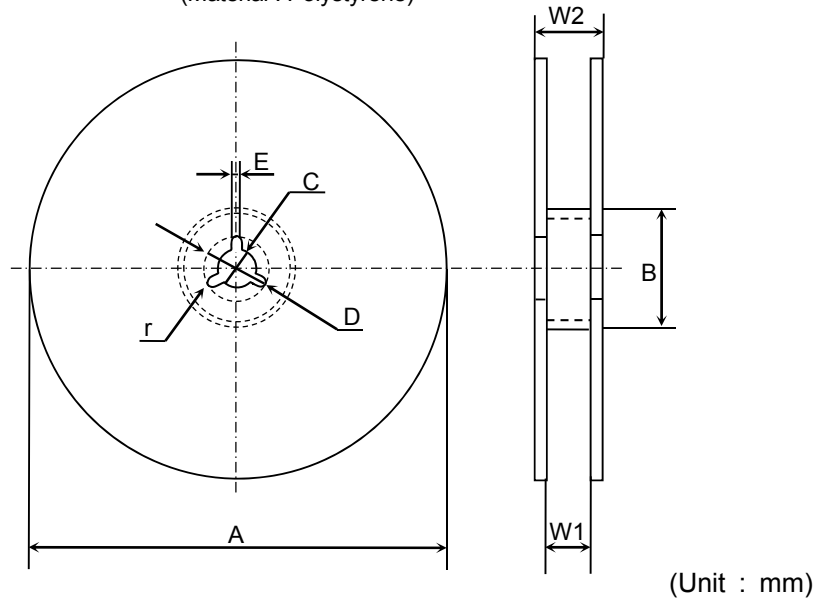

Symbol	A	B	C	D	E	W_1
Dimension	$\varnothing 178 \pm 2.0$	$\varnothing 60 \pm 2.0$	$\varnothing 13 \pm 0.5$	$\varnothing 21 \pm 0.8$	2.0 ± 0.5	13.0 ± 0.3
Symbol	W_2	r				
Dimension	17.0 ± 1.4	1.0				

Appendix 9

C1005, C1608, C2012, C3216, C3225
 (As for C3225 type, any thickness of the item except 2.5mm)
 (Material : Polystyrene)

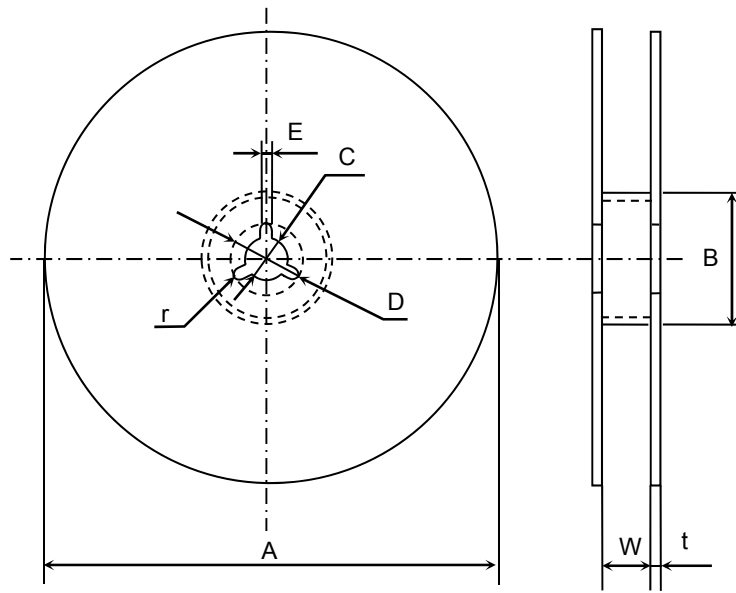

(Unit : mm)

Symbol	A	B	C	D	E	W
Dimension	Ø382 max. (Nominal Ø330)	Ø50 min.	Ø13 ± 0.5	Ø21 ± 0.8	2.0 ± 0.5	10.0 ± 1.5

Symbol	t	r
Dimension	2.0 ± 0.5	1.0

Appendix 10

C3225, C4532, C5750 (As for C3225 type, applied to 2.5mm thickness products)
 (Material : Polystyrene)

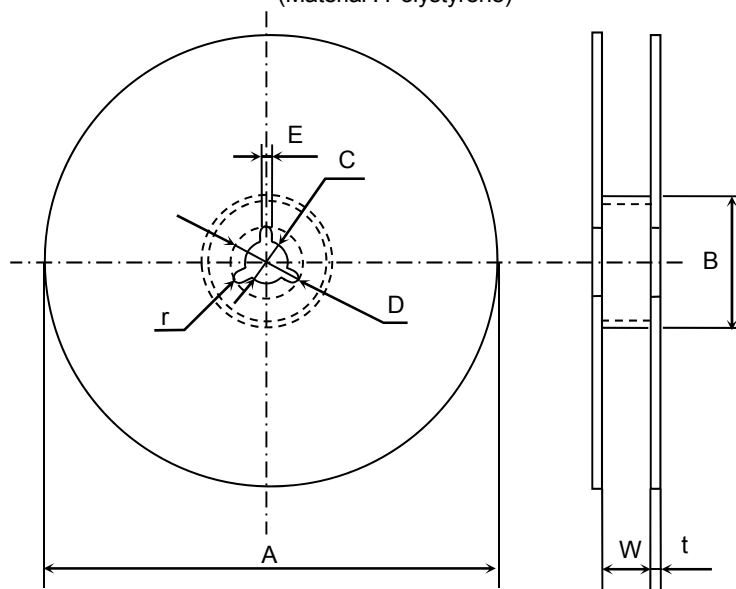

(Unit : mm)

Symbol	A	B	C	D	E	W
Dimension	Ø382 max. (Nominal Ø330)	Ø50 min.	Ø13 ± 0.5	Ø21 ± 0.8	2.0 ± 0.5	14.0 ± 1.5

Symbol	t	r
Dimension	2.0 ± 0.5	1.0